



## Listino prezzi/Price list 2018

PREZZI : EX WORKS, PER COLORI METALLIZZATI PREZZI DA SPECIFICARE

PRICES : EW WORKS, FOR METALLIC COLOURS PRICES TO BE GIVEN





## **Cappe per l'induzione/Induction hoods**



Modello/Model	Codice/Code	Materiale/Material	Motore/Motor	Comandi/Controls	Illuminazione/Lighting	Prezzo/Price €
1121-60	K01121060EXL1	INOX	275 W	TOUCH ON GLASS/	LED SPOTS	€ 920,00
1121-90	K01121090EXL1	INOX	275 W	TOUCH SU VETRO/	LED SPOTS	€ 990,00
1121-120	K01121120EXL1	INOX	275 W	TOUCH ON GLASS/	LED SPOTS	€ 1.072,00

**Accessori (non inclusi)/Accessories (not included)**

KIT FILTRANTE/FILTERING KIT  
 FILTRO CARBONE/ CHARCOAL FILTER

**Codice/Code**

K01121KIT  
 55046266

**Prezzo/Price**

€ 198,00  
 € 40,00

**Note:** POSSIBILE VERSIONE MOTORE ESTERNO/ POSSIBLE VERSION EXTERNAL MOTOR



Modello/Model	Codice/Code	Materiale/Material	Motore/Motor	Comandi/Controls	Illuminazione/Lighting	Prezzo/Price €
1134-90	K01134090EX	AISI 430	275 W	Elettronica/Electronic	Barra Led/ Led bar	€ 1.099,00
1134-120	K01134120EX	AISI 430	275 W	Elettronica/Electronic	Barra Led/ Led bar	€ 1.200,00

**Accessori (non inclusi)/Accessories (not included)**

Filtro carbone cilindrico/Cylindric carbon filter

**Codice/Code**

55046244

**Prezzo/Price**

€ 94,00

**Note:**

POSSIBILE VERSIONE MOTORE ESTERNO/ POSSIBLE VERSION EXTERNAL MOTOR



Modello/Model	Codice/Code	Materiale/Material	Motore/Motor	Comandi/Controls	illuminazione/Lighting	Prezzo/Price €
1134-90 I	K01134090EXI	AISI 430	275 W	Elet+Tel./ Elec+Rem	Barra Led/ Led bar	€ 1.392,00
1134-120 I	K01134120EXI	AISI 430	275 W	Elet+Tel./ Elec+Rem	Barra Led/ Led bar	€ 1.526,00

#### Accessori (non inclusi)/Accessories (not included)

Filtro carbone cilindrico/Cylindric carbon filter

#### Codice/Code

55046244

#### Prezzo/Price

€ 94,00

#### Note:

POSSIBILE VERSIONE MOTORE ESTERNO/ POSSIBLE VERSION EXTERNAL MOTOR



Modello/Model	Codice/Code	Materiale/Material	Motore/Motor	Comandi/Controls	Illuminazione/Lighting	Prezzo/Price €
1135-90	K01135090EX-H60	AISI 430	275 W	Elettronica/Electronic	Barra Led/ Led bar	€ 1.166,00
1135-120	K01135120EX-H60	AISI 430	275 W	Elettronica/Electronic	Barra Led/ Led bar	€ 1.243,00
1135-90	K01135090EX-H90	AISI 430	275 W	Elettronica/Electronic	Barra Led/ Led bar	€ 1.296,00
1135-120	K01135120EX-H90	AISI 430	275 W	Elettronica/Electronic	Barra Led/ Led bar	€ 1.392,00

**Accessori (non inclusi)/Accessories (not included)**

Filtro carbone cilindrico/Cylindric carbon filter

**Codice/Code**

55046244

**Prezzo/Price**

€ 94,00

**Note:**

POSSIBILE VERSIONE MOTORE ESTERNO/ POSSIBLE VERSION EXTERNAL MOTOR

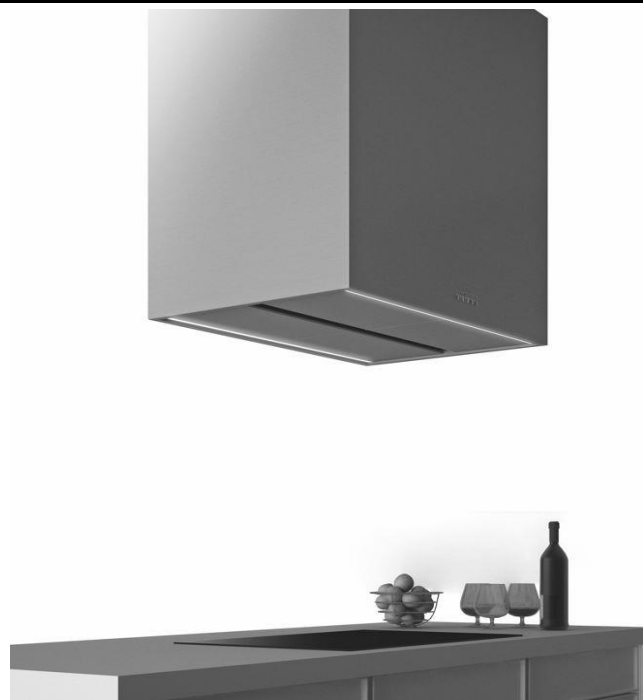

Modello/Model	Codice/Code	Materiale/Material	Motore/Motor	Comandi/Controls	Illuminazione/Lighting	Prezzo/Price €
1135-90 I	K01135090EXI-H60	AISI 430	275 W	Elet+Tel./ Elec+Rem	Barra Led/ Led bar	€ 1.493,00
1135-120 I	K01135120EXI-H60	AISI 430	275 W	Elet+Tel./ Elec+Rem	Barra Led/ Led bar	€ 1.656,00
1135-90 I	K01135090EXI-H100	AISI 430	275 W	Elet+Tel./ Elec+Rem	Barra Led/ Led bar	€ 1.637,00
1135-120 I	K01135120EXI-H100	AISI 430	275 W	Elet+Tel./ Elec+Rem	Barra Led/ Led bar	€ 1.824,00

#### Accessori (non inclusi)/Accessories (not included)

Filtro carbone cilindrico/Cylindric carbon filter

#### Codice/Code

55046244

#### Prezzo/Price

€ 94,00

#### Note:

POSSIBILE VERSIONE MOTORE ESTERNO/ POSSIBLE VERSION EXTERNAL MOTOR





Modello/Model	Codice/Code	Materiale/Material	Motore/Motor	Comandi/Controls	illuminazione/Lighting	Prezzo/Price €
6282-90	K06282090EC	AISI 430 + VERN./PAINT	275 W	touch/touch control	Barra Led/ Led bar	€ 1.704,00
6282-120	K06282120EC	AISI 430 + VERN./PAINT	275 W	touch/touch control	Barra Led/ Led bar	€ 1.803,00

QUOTAZIONE PER COLORI METALLIZZATI/ QUOTATION FOR METALLIC COLOURS

FIM 6282-90	K06282090EC	AISI 430 + VERN./PAINT	275 W	touch/touch control	Barra Led/ Led bar	€ 2.074,00
FIM 6282-120	K06282120EC	AISI 430 + VERN./PAINT	275 W	touch/touch control	Barra Led/ Led bar	€ 2.223,00

**Accessori (non inclusi)/Accessories (not included)**

Filtro carbone cilindrico/Cylindric carbon filter

**Codice/Code**

55046244

**Prezzo/Price**

€ 94,00

**Note:**

POSSIBILE VERSIONE MOTORE ESTERNO/ POSSIBLE VERSION EXTERNAL MOTOR





**Cappe da piano/Base hoods**



Modello/Model	Codice/Code	Materiale/Material	Motore/Motor	Comandi/Controls	Illuminazione/Lighting	Prezzo/Price €
41-80P11	K0041080EXX11	AISI 430	RE225 - 145 W	EL + TOUCH	Barra Led/ Led bar	€ 2.210,00
41-90P11	K0041090EXX11	AISI 430	RE225 - 145 W	EL + TOUCH	Barra Led/ Led bar	€ 2.210,00
41-120P11	K00411120EXX11	AISI 430	RE225 - 145 W	EL + TOUCH	Barra Led/ Led bar	€ 2.403,00
41-80P26	K0041080EXX26	AISI 430	RE250W - 190 W	EL + TOUCH	Barra Led/ Led bar	€ 2.015,00
41-90P26	K0041090EXX26	AISI 430	RE250W - 190 W	EL + TOUCH	Barra Led/ Led bar	€ 2.015,00
41-120P26	K0041120EXX26	AISI 430	RE250W - 190 W	EL + TOUCH	Barra Led/ Led bar	€ 2.208,00
41-80	K600411080EXX	AISI 430	FOR EXTERNAL MOTOR	EL + TOUCH	Barra Led/ Led bar	€ 1.926,00
41-90	K60041090EXX	AISI 430	FOR EXTERNAL MOTOR	EL + TOUCH	Barra Led/ Led bar	€ 1.926,00
41-120	K60041120EXX	AISI 430	FOR EXTERNAL MOTOR	EL + TOUCH	Barra Led/ Led bar	€ 2.119,00

**Accessori (non inclusi)/Accessories (not included)**

	Codice/Code	Prezzo/Price
FILTRO CARBONE/CARBON FILTER	55090003-2	€ 84,00
FILTRO CARBONE/CARBON FILTER	55090004-2	€ 96,00
TELECOMANDO/REMOTE CONTROL	R01319006	€ 70,00
OUTLET KIT	K0630KITR	€ 50,00

**Note:**  
POSSIBILE CON TUTTI I MOTORI ESTERNI E DA ZOCCOLO- POSSIBLE WITH ALL EXTERNAL MOTORS AND PLINTH MOTOR



Modello/Model	Codice/Code	Materiale/Material	Motore/Motor	Comandi/Controls	Illuminazione/Lighting	Prezzo/Price €
41-80 P11V	K0041080EX11A	AISI 430+ VET/GLAS	RE225 - 145 W	EL + TOUCH	Barra Led/ Led bar	€ 2.210,00
41-90 P11V	K0041090EX11A	AISI 430+ VET/GLAS	RE225 - 145 W	EL + TOUCH	Barra Led/ Led bar	€ 2.210,00
41-120 P11V	K0041120EX11A	AISI 430+ VET/GLAS	RE225 - 145 W	EL + TOUCH	Barra Led/ Led bar	€ 2.403,00
41-80 P26V	K0041080EX26A	AISI 430+ VET/GLAS	RE250W - 190 W	EL + TOUCH	Barra Led/ Led bar	€ 2.015,00
41-90 P26V	K0041090EX26A	AISI 430+ VET/GLAS	RE250W - 190 W	EL + TOUCH	Barra Led/ Led bar	€ 2.015,00
41-120 P26V	K0041120EX26A	AISI 430+ VET/GLAS	RE250W - 190 W	EL + TOUCH	Barra Led/ Led bar	€ 2.208,00
41-80 V	K60041080EXA	AISI 430+ VET/GLAS	PER MOT. EXT/FOREXT	EL + TOUCH	Barra Led/ Led bar	€ 1.926,00
41-90 V	K60041090EXA	AISI 430+ VET/GLAS	PER MOT. EXT/FOREXT	EL + TOUCH	Barra Led/ Led bar	€ 1.926,00
41-120 V	K60041120EXA	AISI 430+ VET/GLAS	PER MOT. EXT/FOREXT	EL + TOUCH	Barra Led/ Led bar	€ 2.119,00

**Accessori (non inclusi)/Accessories (not included)**

FILTRO CARBONE/CARBON FILTER  
 FILTRO CARBONE/CARBON FILTER  
 TELECOMANDO/REMOTE CONTROL  
 OUTLET KIT

**Codice/Code**

55090003-2  
 55090004-2  
 R01319006  
 K0630KITR

**Prezzo/Price**

€ 84,00  
 € 96,00  
 € 70,00  
 € 50,00

**Note:**

POSSIBILE CON TUTTI I MOTORI ESTERNI E DA ZOCCOLO- POSSIBLE WITH ALL EXTERNAL MOTORS AND PLINTH MOTOR



Modello/Model	Codice/Code	Materiale/Material	Motore/Motor	Comandi/Controls	Illuminazione/Lighting	Prezzo/Price €
1156-56P11	K01156056EX11	AISI 430	RE 225-145 W	TOUCH CONTROL	Barra Led/ Led bar	€ 1.848,00
1156-86P11	K01156086EX11	AISI 430	RE 225-145 W	TOUCH CONTROL	Barra Led/ Led bar	€ 1.920,00
1156-90P11	K01156090EX11	AISI 430	RE 225-145 W	TOUCH CONTROL	Barra Led/ Led bar	€ 1.920,00
1156-116P11	K01156116EX11	AISI 430	RE 225-145 W	TOUCH CONTROL	Barra Led/ Led bar	€ 2.016,00
1156-56P26	K01156056EX26	AISI 430	GPE800- 275 W	TOUCH CONTROL	Barra Led/ Led bar	€ 1.759,00
1156-86P26	K01156086EX26	AISI 430	GPE800- 275 W	TOUCH CONTROL	Barra Led/ Led bar	€ 1.832,00
1156-90P26	K01156090EX26	AISI 430	GPE800- 275 W	TOUCH CONTROL	Barra Led/ Led bar	€ 1.832,00
1156-116P26	K01156116EX26	AISI 430	GPE800- 275 W	TOUCH CONTROL	Barra Led/ Led bar	€ 1.926,00
1156-56	K601156056EX	AISI 430	MOT. EXT.	TOUCH CONTROL	Barra Led/ Led bar	€ 1.577,00
1156-86	K601156086EX	AISI 430	MOT. EXT.	TOUCH CONTROL	Barra Led/ Led bar	€ 1.651,00
1156-96	K601156090EX	AISI 430	MOT. EXT.	TOUCH CONTROL	Barra Led/ Led bar	€ 1.651,00
1156-116	K601156116EX	AISI 430	MOT. EXT.	TOUCH CONTROL	Barra Led/ Led bar	€ 1.730,00
1156-56	K601156056EX1	AISI 430	PLINTHMOT/MOT.Z	TOUCH CONTROL	Barra Led/ Led bar	€ 1.577,00
1156-86	K601156086EX1	AISI 430	PLINTHMOT/MOT.Z	TOUCH CONTROL	Barra Led/ Led bar	€ 1.651,00
1156-90	K601156090EX1	AISI 430	PLINTHMOT/MOT.Z	TOUCH CONTROL	Barra Led/ Led bar	€ 1.651,00
1156-116	K601156116EX1	AISI 430	PLINTHMOT/MOT.Z	TOUCH CONTROL	Barra Led/ Led bar	€ 1.730,00

**Accessori (non inclusi)/Accessories (not included)**

Motor Box Standard	RAK2533286	€ 314,00
Kit filtrante/Filtering Kit	K06060KIT	€ 165,00
Filtro carbone da zoccolo/Charcoal Filter for Plinth	55046232	€ 265,00
Telecomando/Remote Control	R01319006	€ 70,00
Connessione rettangolare/Rectangular Junction 220X90	06011059	€ 31,00
Connessione circolare / Circular Junction 150, 220X90	06011037	€ 45,00

**Codice/Code**

RAK2533286
K06060KIT
55046232
R01319006
06011059
06011037

**Prezzo/Price**

€ 314,00
€ 165,00
€ 265,00
€ 70,00
€ 31,00
€ 45,00

AGGIUNGERE COSTI MOTORI DA ZOCCOLO O ESTERNI ( EX1 )  
 COST OF PLINTH MOTOR OR EXTERNAL MOTOR TO BE ADDED ( EX1 )

=

**Note:** POSSIBILE CON TUTTI I MOTORI ESTERNI E DA ZOCCOLO, VERSIONE DA 90 CONTROLLATA DA PIANO FIM 4001  
 POSSIBLE WITH ALL EXTERNAL MOTOR AND PLINTH MOTOR, VERSION 90 POSSIBLE CONTROLLED BY HOB FIM 4001



Modello/Model	Codice/Code	Materiale/Material	Motore/Motor	Comandi/Controls	Illuminazione/Lighting	Prezzo/Price €
6129	K606129052EXP	AISI 304/430 BLK GLS	Mot. Est/Ext. Motor	TOUCH	-	€ 2.260,00
KIT MOT. BOX	RAK2533286		275 W			€ 314,00
GIUNZ. RETT/REC.JUNC.	RAK2533500	PER MOTORE BOX STANDARD -FOR MOTOR				€ 75,00
GIUNZ. CIR/CIRC. JUNC.	RAK2533557	PER MOTORE DA ZOCOLO- FOR PLINTH MOTOR				€ 135,00

**Accessori (non inclusi)/Accessories (not included)**

KIT FILTRANTE DA PIANO BASE/FILTERING KIT FOR BASE HOOD  
 FILTRO CARBONE/CARBON FILTER

**Codice/Code**

K06060KIT  
 55046232

**Prezzo/Price**

€ 165,00  
 € 265,00

**Note:**



Modello/Model	Codice/Code	Materiale/Material	Motore/Motor	Comandi/Controls	Illuminazione/Lighting	Prezzo/Price €
6195	K606195090EX	AISI 430/304	MOT. EXT/EXT.MOT	Telecom,/remote	No luce/No light	€ 1.445,00
KIT MOT. BOX	RAK2533286		275 W			€ 314,00
GIUNZ. RETT/REC.JUNC.	RAK2533500	PER BOX MOTOR				€ 75,00
GIUNZ. CIR/CIRC. JUNC.	RAK2533557	PER ZOCCOLO/FOR PLINTH				€ 135,00

**Accessori (non inclusi)/Accessories (not included)**

KIT FILTRANTE DA PIANO BASE/FILTERING KIT FOR BASE HOOD  
 FILTRO CARBONE/CARBON FILTER

**Codice/Code**

K06060KIT  
 55046232

**Prezzo/Price**

€ 165,00  
 € 265,00

**Note:** POSSIBLE CON TUTTI I MOTORI ESTERNI E DA ZOCCOLO- POSSIBLE WITH ALL EXTERNAL MOTOR AND PLINTH MOTOR- PIANO DA AGG. FIM 4001  
 POSSIBLE TO ADD FIM4001 - 80400742



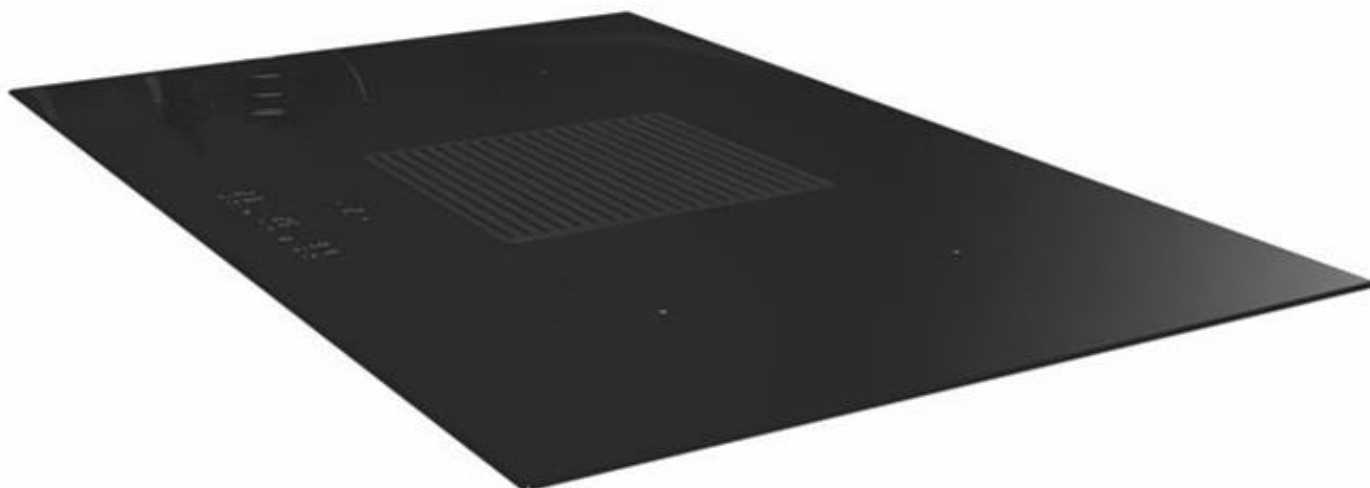

Modello/Model	Codice/Code	Materiale/Material	Motore/Motor	Comandi/Controls	illuminazione/Lighting	Prezzo/Price €
6261	K606261090EXP	INOX+BLACK GLASS	FOR EXT. MOTOR			€ 1.725,00
MOTOR BOX STAND.	RAK2533286					€ 314,00

MOTORI DA ZOCCOLO POSSIBILI/POSSIBLE FOR PLINTH MOTORS

K06149CEI vedere sezione mot. esterni/see section external motors

K06153CEI vedere sezione mot. esterni/see section external motors

TUBI NABER/NABER PIPES

**Accessori (non inclusi)/Accessories (not included)**

KIT FILTRANTE DA PIANO BASE/FILTERING KIT FOR BASE HOOD

FILTRO CARBONE/CARBON FILTER

GIUNZIONE RETTANGOLARE/RECTANGULAR JUNCTION 220X90

GIUNZIONE CIRCOLARE/CIRCULAR JUNCTION 150 MM

TUBO RETT. /RECT. PIPE 220X90X1000

**Codice/Code**

K06060KIT

55046232

06011020

06011022

06011017

**Prezzo/Price**

€ 165,00

€ 265,00

€ 44,50

€ 48,00

€ 50,50

**Note:**

POSSIBILE CON TUTTI I MOTORI ESTERNI E DA ZOCCOLO- POSSIBLE WITH ALL EXTERNAL MOTOR AND PLINTH MOTOR

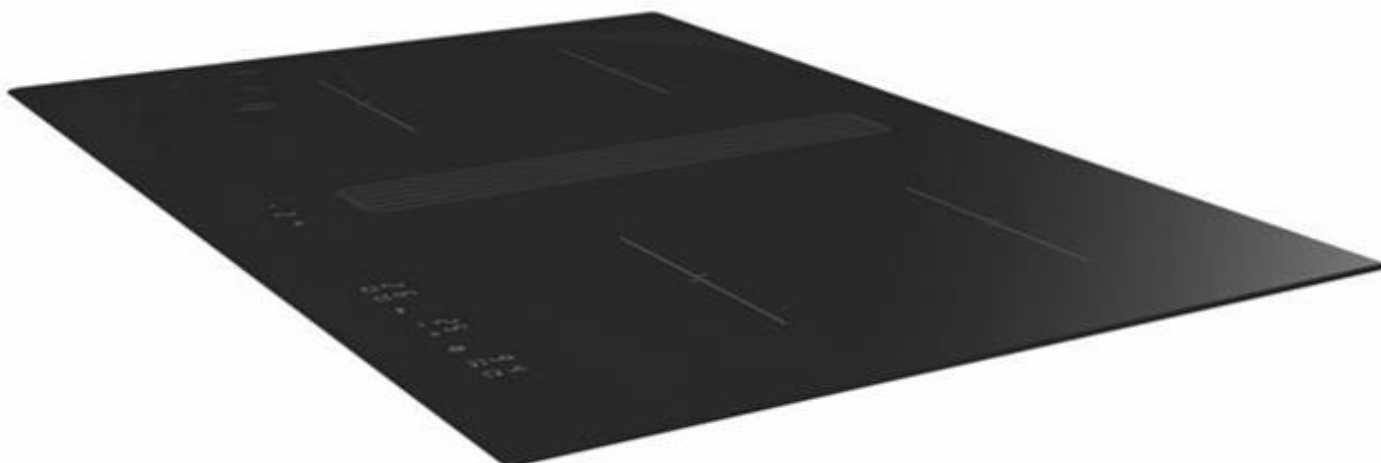

Modello/Model	Codice/Code	Materiale/Material	Motore/Motor	Comandi/Controls	Illuminazione/Lighting	Prezzo/Price €
6262	K6062620520EXP	INOX + BLACK GLASS	EXTERNAL MOTOR			€ 1.728,00
KIT MOT. BOX	RAK2533286					€ 314,00
GIUNZ. RETT/REC.JUNC.	RAK2533500	PER MOT. STANDARD				€ 75,00
GIUNZ. CIR/CIRC. JUNC.	RAK2533557	PER MOT. ZOCC./FOR PLINTH MOTOR				€ 135,00

**MOTORI DA ZOCCOLO POSSIBILI/POSSIBLE FOR PLINTH MOTORS**

K06149CEI	vedere sezione mot. esterni/see section external motors
K06153CEI	vedere sezione mot. esterni/see section external motors

**Accessori (non inclusi)/Accessories (not included)**

KIT FILTRANTE DA PIANO BASE/FILTERING KIT FOR BASE HOOD  
 FILTRO CARBONE/CARBON FILTER

**Codice/Code**

K06060KIT  
 55046232

**Prezzo/Price**

€ 165,00  
 € 265,00

**Note:**

POSSIBLE CON TUTTI I MOTORI ESTERNI E DA ZOCCOLO- POSSIBLE WITH ALL EXTERNAL MOTOR AND PLINTH MOTOR



## **Cappe a controsoffitto/False ceiling hoods**



Modello/Model	Codice/Code	Materiale/Material	Motore/Motor	Comandi/Controls	Illuminazione/Lighting	Prezzo/Price €
468	K90468090EXL	AISI 430	275 W	Elec.+Tel/Elec.+ Rem.	Led spots	€ 1.237,00

**Accessori (non inclusi)/Accessories (not included)**

Filtro carbone/Charcoal filter  
 FILTERING CASSETTE LONG LIFE

**Codice/Code**

55090013-4  
 KKIT003CF

**Prezzo/Price**

€ 189,00  
 € 301,00

**Note:** POSSIBLE VERSIONE MOTORE ESTERNO E RAL  
 POSSIBLE VERSION FOR EXTERNAL MOTOR AND RAL COLOUR



Modello/Model	Codice/Code	Materiale/Material	Motore/Motor	Comandi/Controls	illuminazione/Lighting	Prezzo/Price €
662-90x30	K6066209030EXL	AISI 430	MOT. EST./EXT. MOTOR	ELEC+TEL/EL+REMOTE	Led spots 1 W	€ 662,00
662-120x30	K6066212030EXL	AISI 430	MOT. EST./EXT. MOTOR	ELEC+TEL/EL+REMOTE	Led spots 1 W	€ 789,00
662-90x30	K066209030EXL	AISI 430	275 W	ELEC+TEL/EL+REMOTE	Led spots 1 W	€ 718,00
662-120x30	K066212030EXL	AISI 430	275 W	ELEC+TEL/EL+REMOTE	Led spots 1 W	€ 846,00
662-90x30 M	K066209030EXLM	AISI 430	275 W REM.	ELEC+TEL/EL+REMOTE	Led spots 1 W	€ 883,00
662-120x30 M	K066212030EXLM	AISI 430	275 W REM.	ELEC+TEL/EL+REMOTE	Led spots 1 W	€ 1.009,00

SUPPLEMENTO PER VERSIONE COLOR NON METALLIZZATO/INCREASE IN PRICE FOR NON METALLIC COLOUR

90X30	€ 175,00
120X30	€ 210,00

#### Accessori (non inclusi)/Accessories (not included)

	Codice/Code	Prezzo/Price
KIT FILTRO CARB. LAV/CARBON FILTER KIT 90X30 WASHABLE	55090002-2	€ 69,00
KIT FILTRO CARB. LAV/ CARBON FILTER KIT 120X30 WASHABLE	55090002-3	€ 96,00
CASSETTA FILTR./FILTERING CASSETTE LONG LIFE	KKIT003CF	€ 301,00

**Note:** POSSIBILE VERSIONE COLORATA - POSSIBLE VERSION WITH PAINTED COLOURS



Modello/Model	Codice/Code	Materiale/Material	Motore/Motor	Comandi/Controls	Illuminazione/Lighting	Prezzo/Price €
662-90x50	K60662090EXL	AISI 430	PER MOT.EST//FOR EXT.	ELEC+TEL/EL+REMOTE	Led spots 1 W	€ 818,00
662-120x50	K6066212050EXL	AISI 430	PER MOT.EST//FOR EXT.	ELEC+TEL/EL+REMOTE	Led spots 1 W	€ 928,00
662-90x50	K0662090EXL	AISI 430	275 W	ELEC+TEL/EL+REMOTE	Led spots 1 W	€ 873,00
662-120x50	K066212050EXL	AISI 430	275 W	ELEC+TEL/EL+REMOTE	Led spots 1 W	€ 985,00
662-90x50 R	K0662090EXLR	AISI 430	RADIAL RE225 - 145 W	ELEC+TEL/EL+REMOTE	Led spots 1 W	€ 964,00
662-120x50 R	K066212050EXLR	AISI 430	RADIAL RE225 -145 W	ELEC+TEL/EL+REMOTE	Led spots 1 W	€ 1.076,00
662-90x50 M	K0662090EXLM	AISI 430	275 W REM	ELEC+TEL/EL+REMOTE	Led spots 1 W	€ 1.039,00
662-120x50 M	K066212050EXLM	AISI 430	275 W REM	ELEC+TEL/EL+REMOTE	Led spots 1 W	€ 1.149,00

SUPPLEMENTO PER VERSIONE COLOR NON METALLIZZATO/INCREASE IN PRICE FOR NON METALLIC COLOUR

90X50	€ 185,00
120X50	€ 210,00

#### Accessori (non inclusi)/Accessories (not included)

	Codice/Code	Prezzo/Price
KIT FILTRO CARB. LAV/CARBON FILTER KIT 90X50 WASHABLE	55090008-3	€ 128,00
KIT FILTRO CARB.LAV/CARBON FILTER KIT 120X50 WASHABLE	55090028-3	€ 146,00
CASSETTA FILTR./FILTERING CASSETTE LONG LIFE	KKIT003CF	€ 301,00

**Note:** POSSIBILE VERSIONE COLORATA - POSSIBLE VERSION WITH PAINTED COLOURS



Modello/Model	Codice/Code	Materiale/Material	Motore/Motor	Comandi/Controls	Illuminazione/Lighting	Prezzo/Price €
662-120X70	K60662120EXL	AISI 430	PER MOT.EST/FOR EXT.	ELEC+TEL/EL+REMOTE	Led spots 1 W	€ 1.053,00
662-120X70	K066212070EXL	AISI 430	275 W	ELEC+TEL/EL+REMOTE	Led spots 1 W	€ 1.109,00
662-120X70 R	K0662120EXLR	AISI 430	RAD. 145 RE225	ELEC+TEL/EL+REMOTE	Led spots 1 W	€ 1.200,00
662-120X70 M	K0662120EXLM	AISI 430	275 W REM.	ELEC+TEL/EL+REMOTE	Led spots 1 W	€ 1.273,00
SUPPLEMENTO PER VERSIONE COLOR NON METALLIZZATO/INCREASE IN PRICE FOR NON METALLIC COLOUR 120X70						€ 235,00

**Accessori (non inclusi)/Accessories (not included)**

Filtro carbone/Charcoal filter

FILTR. CARB. LAV.(CARBON FILTER KIT 120X70 WASHABLE

CASSETTA FILTRANTE /FILTERING CASSETTE LONG LIFE

**Codice/Code**

55090009-4

KKIT003CF

**Prezzo/Price**

€ 190,00

€ 301,00

**Note:**

POSSIBILE VERSIONE COLORATA - POSSIBLE VERSION WITH PAINTED COLOURS



Modello/Model	Codice/Code	Materiale/Material	Motore/Motor	Comandi/Controls	Illuminazione/Lighting	Prezzo/Price €
6038-60X60	K60603806060EX	AISI 430	EXT. MOT	ELEC+TEL/EL+REMOTE	PANN.LED/LED PANEL	€ 1.207,00
6038-90X50	K60603809050EX	AISI 430	EXT. MOT	ELEC+TEL/EL+REMOTE	PANN.LED/LED PANEL	€ 1.242,00
6038-130X70	K60603813070EX	AISI 430	EXT. MOT	ELEC+TEL/EL+REMOTE	PANN.LED/LED PANEL	€ 1.699,00
6038-60X60	K90603806060EX	AISI 430	275 W	ELEC+TEL/EL+REMOTE	PANN.LED/LED PANEL	€ 1.268,00
6038-90X50	K90603809050EX	AISI 430	275 W	ELEC+TEL/EL+REMOTE	PANN.LED/LED PANEL	€ 1.304,00
6038-130X70	K90603813070EX	AISI 430	275 W	ELEC+TEL/EL+REMOTE	PANN.LED/LED PANEL	€ 1.760,00
6038-60X60 R	K0603806060EXR	AISI 430	RADIAL 145 W	ELEC+TEL/EL+REMOTE	PANN.LED/LED PANEL	€ 1.375,00
6038-90X50 R	K0603809050EXR	AISI 430	RADIAL 145 W	ELEC+TEL/EL+REMOTE	PANN.LED/LED PANEL	€ 1.410,00
6038-130X70 R	K0603813070EXR	AISI 430	RADIAL 145 W	ELEC+TEL/EL+REMOTE	PANN.LED/LED PANEL	€ 1.868,00
6038-90X50 M	K90603809050EXM	AISI 430	275 W REM	ELEC+TEL/EL+REMOTE	PANN.LED/LED PANEL	€ 1.482,00

**Accessori (non inclusi)/Accessories (not included)**

FILTRO CARB. LAV./CARBON FILTER KIT 60X60 WASHABLE  
 FILTRO CARB. LAV./CARBON FILTER KIT 90X50 WASHABLE  
 FILTRO CARB. LAV./CARBON FILTER KIT 130X70 WASHABLE  
 CASSETTA FILTR./FILTERING CASSETTE LONG LIFE

**Codice/Code**

55081006  
 55081003-2  
 55081006-2  
 KKIT003CF

**Prezzo/Price**

€ 110,00  
 € 170,00  
 € 210,00  
 € 301,00

POSSIBILE VERSIONE COLORATA - POSSIBLE VERSION WITH PAINTED COLOURS



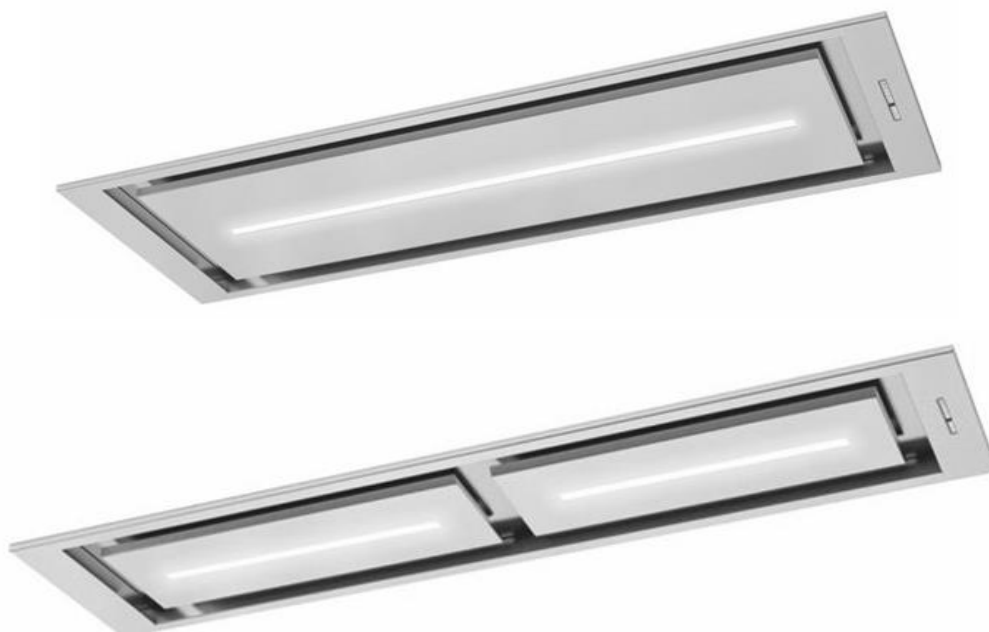

Modello/Model	Codice/Code	Materiale/Material	Motore/Motor	Comandi/Controls	illuminazione/Lighting	Prezzo/Price €
6072-90X30	K60607209030EXBL	AISI 430	MOT. EST/EXT. MOTOR	ELEC.+ TEL./ELEC.+REM	BARRA LED/LED BAR	€ 800,00
6072-120X30	K606072012030EXBL	AISI 430	MOT. EST/EXT. MOTOR	ELEC.+ TEL./ELEC.+REM	BARRA LED/LED BAR	€ 1.116,00
6072-90X30	K0607209030EXBL	AISI 430	INT. MOTOR	ELEC.+ TEL./ELEC.+REM	BARRA LED/LED BAR	€ 856,00
6072-120X30	K06072012030EXBL	AISI 430	INT. MOTOR	ELEC.+ TEL./ELEC.+REM	BARRA LED/LED BAR	€ 1.172,00

SUPPLEMENTO PER VERSIONE COLOR NON METALLIZZATO/INCREASE IN PRICE FOR NON METALLIC COLOUR

90X30	€ 175,00
120X30	€ 210,00

### Accessori (non inclusi)/Accessories (not included)

	Codice/Code	Prezzo/Price
FILTRO CARB. LAV/CARBON FILTER KIT 90X30 WASHABLE	55090002-2	€ 70,00
FILTRO CARB. LAV/CARBON FILTER KIT 120X30 WASHABLE	55090033-2	€ 89,00
CASSETTA FILTR./FILTERING CASSETTE LONG LIFE	KKIT003CF	€ 301,00

POSSIBILE VERSIONE COLORATA - POSSIBLE VERSION WITH PAINTED COLOURS

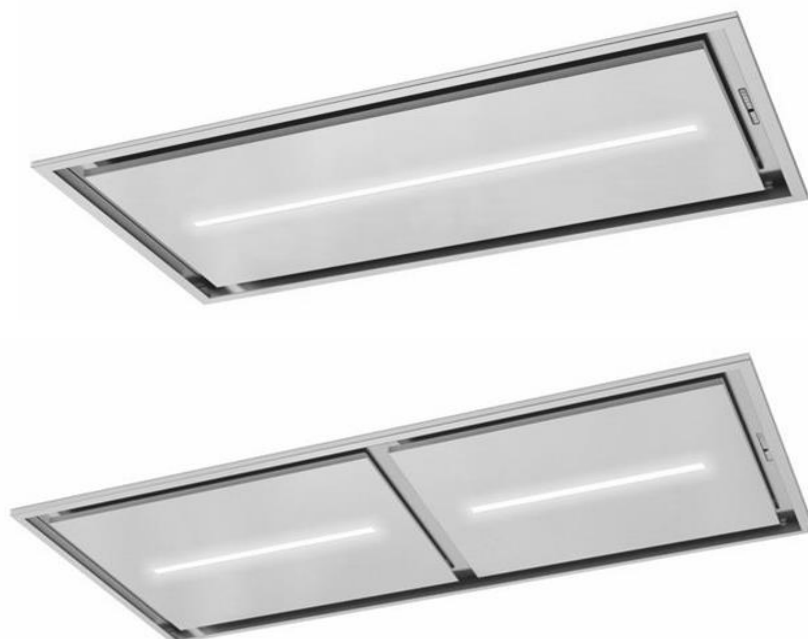

Modello/Model	Codice/Code	Materiale/Material	Motore/Motor	Comandi/Controls	Illuminazione/Lighting	Prezzo/Price €
6072-60X60	K60607206060EXBL	AISI 430	EX. MOTOR	ELEC+TEL/EL+REMOTE	BARRA LED/LED BAR	€ 795,00
6072-90X60	K60607209060EXBL	AISI 430	EX. MOTOR	ELEC+TEL/EL+REMOTE	BARRA LED/LED BAR	€ 893,00
6072-120X60	K60607212060EXBL	AISI 430	EX. MOTOR	ELEC+TEL/EL+REMOTE	BARRA LED/LED BAR	€ 1.209,00
6072-60X60	K0607206060EXBL	AISI 430	275 W	ELEC+TEL/EL+REMOTE	BARRA LED/LED BAR	€ 851,00
6072-90X60	K0607209060EXBL	AISI 430	275 W	ELEC+TEL/EL+REMOTE	BARRA LED/LED BAR	€ 949,00
6072-120X60	K0607212060EXBL	AISI 430	275 W	ELEC+TEL/EL+REMOTE	BARRA LED/LED BAR	€ 1.265,00
6072-60X60 R	K0607206060EXBLR	AISI 430	RADIAL 145W	ELEC+TEL/EL+REMOTE	BARRA LED/LED BAR	€ 958,00
6072-90X60 R	K0607209060EXBLR	AISI 430	RADIAL 145W	ELEC+TEL/EL+REMOTE	BARRA LED/LED BAR	€ 1.056,00
6072-120X60 R	K0607212060EXBLR	AISI 430	RADIAL 145W	ELEC+TEL/EL+REMOTE	BARRA LED/LED BAR	€ 1.372,00

SUPPLEMENTO PER VERSIONE COLOR NON METALLIZZATO/INCREASE IN PRICE FOR NON METALLIC COLOUR

60X60	€ 185,00
90X60	€ 185,00
120X60	€ 235,00

#### Accessori (non inclusi)/Accessories (not included)

#### Codice/Code

#### Prezzo/Price

##### Filtri Carbone/Charcoal Filter

CARBON FILTER KIT 60X60 WASHABLE	55090031-2	€ 93,00
CARBON FILTER KIT 90X60 WASHABLE	55090032-3	€ 131,00
CARBON FILTER KIT 120X60 WASHABLE	55090007-4	€ 169,00
FILTERING CASSETTE LONG LIFE	KKIT003CF	€ 301,00

NOTE : POSSIBILE CAPPE IN RAL - POSSIBLE VERSION WITH PAINTED



Modello/Model	Codice/Code	Materiale/Material	Motore/Motor	Comandi/Controls	Illuminazione/Lighting	Prezzo/Price €
6186-40	K06186040EX	AISI 430	MOT. INT. 275 W	TELEC./REMOTE	LES SPOTS 2,5 W	€ 610,00
6186-65	K06186065EX	AISI 430	MOT. INT. 275 W	TELEC./REMOTE	LES SPOTS 2,5 W	€ 685,00
6186-95	K06186095EX	AISI 430	MOT. INT. 275 W	TELEC./REMOTE	LES SPOTS 2,5 W	€ 738,00
6186-40	K06186040EC	AISI 430+ RAL	MOT. INT. 275 W	TELEC./REMOTE	LES SPOTS 2,5 W	€ 713,00
6186-65	K06186065EC	AISI 430+ RAL	MOT. INT. 275 W	TELEC./REMOTE	LES SPOTS 2,5 W	€ 796,00
6186-95	K06186095EC	AISI 430+ RAL	MOT. INT. 275 W	TELEC./REMOTE	LES SPOTS 2,5 W	€ 870,00

**Accessori (non inclusi)/Accessories (not included)**

	Codice/Code	Prezzo/Price
FILTRO CARB. LAV/CARBON FILTER KIT 40 WASHABLE	55090034	€ 55,00
FILTRO CARB. LAV/CARBON FILTER KIT 65 WASHABLE	55090035	€ 89,00
FILTRO CARB. LAV/CARBON FILTER KIT 95 WASHABLE	55090036-2	€ 110,00

POSSIBLE VERSIONE MOTORE ESTERNO- POSSIBLE VERSION EXTERNAL MOTOR



Modello/Model	Codice/Code	Materiale/Material	Motore/Motor	Comandi/Controls	Illuminazione/Lighting	Prezzo/Price €
6279-90X50	K60627909050EXL	AISI 430	FOR EXT. MOTOR	TELEC./REMOTE NO ELEC	LED SPOT	€ 681,00
6279-120X50	K60627912050EXL	AISI 430	FOR EXT. MOTOR	TELEC./REMOTE NO ELEC	LED SPOT	€ 735,00
6279-120X70	K60627912070EXL	AISI 430	FOR EXT. MOTOR	TELEC./REMOTE NO ELEC	LED SPOT	€ 959,00
6279-90X50	K0627909050EXL	AISI 430	275 W- GPE 800	TELEC./REMOTE NO ELEC	LED SPOT	€ 820,00
6279-120X50	K0627912050EXL	AISI 430	275 W- GPE 800	TELEC./REMOTE NO ELEC	LED SPOT	€ 875,00
6279-120X70	K0627912070EXL	AISI 430	275 W- GPE 800	TELEC./REMOTE NO ELEC	LED SPOT	€ 1.096,00
6279-90X50 R	K0627909050EXLR	AISI 430	RADIAL 145 W-RE225	TELEC./REMOTE NO ELEC	LED SPOT	€ 916,00
6279-120X50 R	K0627912050EXLR	AISI 430	RADIAL 145 W-RE225	TELEC./REMOTE NO ELEC	LED SPOT	€ 975,00
6279-120X70 R	K0627912070EXLR	AISI 430	RADIAL 145 W-RE225	TELEC./REMOTE NO ELEC	LED SPOT	€ 1.196,00
6279-90X50 M	K0627909050EXLM	AISI 430	275 W REM	TELEC./REMOTE NO ELEC	LED SPOT	€ 985,00
6279-120X50 M	K0627912050EXLM	AISI 430	275 W REM	TELEC./REMOTE NO ELEC	LED SPOT	€ 1.039,00
6279-120X70 M	K06279012050EXLM	AISI 430	275 W REM	TELEC./REMOTE NO ELEC	LED SPOT	€ 1.260,00

SUPPLEMENTO PER VERSIONE COLOR NON METALLIZZATO/INCREASE IN PRICE FOR NON METALLIC COLOUR

90X50	€ 185,00
120X50	€ 210,00
120X70	€ 250,00

#### Accessori (non inclusi)/Accessories (not included)

	Codice/Code	Prezzo/Price
FILTRO CARB. LAV/CARBON FILTER KIT 90X50 WASHABLE	55090008-3	€ 128,00
FILTRO CARB. LAV/CARBON FILTER KIT 120X50 WASHABLE	55090028-3	€ 146,00
CASSETTA FILTRANTE/FILTERING CASSETTE LONG LIFE	KKIT003CF	€ 301,00
KIT MOTORE RADIALE/KIT RADIAL MOTOR	K0662090KITRM1	€ 435,00



Modello/Model	Codice/Code	Materiale/Material	Motore/Motor	Comandi/Controls	Illuminazione/Lighting	Prezzo/Price €
6280	K606280090EX	AISI 430	PER MOT. EST- FOR EXT	Solo Telecom.Only remote	Pannello Led/Led panel	€ 1.478,00
	K606280090EC	AISI 430 + RAL	PER MOT. EST- FOR EXT	Solo Telecom.Only remote	Pannello Led/Led panel	€ 1.637,00
	K06280090EX	AISI 430	275 W	Solo Telecom.Only remote	Pannello Led/Led panel	€ 1.536,00
	K06280090EC	AISI 430 + RAL	275 W	Solo Telecom.Only remote	Pannello Led/Led panel	€ 1.695,00

**Accessori (non inclusi)/Accessories (not included)**

FILTRO CARBONE LAV.CARBON FILTER ( WASHABLE)  
CASSETTA FILTR./FILTERING CASSETTE LONG LIFE

**Codice/Code**

55081001  
KKIT003CF

**Prezzo/Price**

€ 54,00  
€ 301,00



Modello/Model	Codice/Code	Materiale/Material	Motore/Motor	Comandi/Controls	Illuminazione/Lighting	Prezzo/Price €
6294-90X50	K60629409050EXL	AISI 430	MOT. EXT/EXT MOTOR	telecomando/remote	4 leds	€ 605,00
6294-120X50	K60629412050EXL	AISI 430	MOT. EXT/EXT MOTOR	telecomando/remote	4 leds	€ 657,00
6294-120X70	K60629412070EXL	AISI 430	MOT. EXT/EXT MOTOR	telecomando/remote	4 leds	€ 797,00
6294-90X50	K0629409050EXL	AISI 430	MOT. GPE838 - 275 W	telecomando/remote	4 leds	€ 761,00
6294-120X50	K0629412050EXL	AISI 430	MOT. GPE838 - 275 W	telecomando/remote	4 leds	€ 816,00
6294-120X70	K0629412070EXL	AISI 430	MOT. GPE838 - 275 W	telecomando/remote	4 leds	€ 955,00
6294-90X50 R	K0629409050EXLR	AISI 430	RADIALE/RADIAL - 145 W	telecomando/remote	4 leds	€ 856,00
6294-120X50 R	K0629412050EXLR	AISI 430	RADIALE/RADIAL - 145 W	telecomando/remote	4 leds	€ 908,00
6294-120X70R	K0629412070EXLR	AISI 430	RADIALE/RADIAL - 145 W	telecomando/remote	4 leds	€ 1.048,00
6294-90X50 M	K0629409050EXLM	AISI 430	REMOV. GPE838- 275 W	telecomando/remote	4 leds	€ 926,00
6294-120X50 M	K0629412050EXLM	AISI 430	REMOV. GPE838- 275 W	telecomando/remote	4 leds	€ 981,00
6294-120X70 M	K0629412070EXLM	AISI 430	REMOV. GPE838- 275 W	telecomando/remote	4 leds	€ 1.121,00
6294-90X50 RAL	K60629409050ECL	AISI 430	MOT. EXT/EXT MOTOR	telecomando/remote	4 leds	€ 758,00
6294-120X50 RAL	K60629412050ECL	AISI 430	MOT. EXT/EXT MOTOR	telecomando/remote	4 leds	€ 832,00
6294-120X70 RAL	K60629412070ECL	AISI 430	MOT. EXT/EXT MOTOR	telecomando/remote	4 leds	€ 981,00
6294-90X50 RAL	K0629409050ECL	AISI 430	MOT. GPE838 - 275 W	telecomando/remote	4 leds	€ 914,00
6294-120X50 RAL	K0629412050ECL	AISI 430	MOT. GPE838 - 275 W	telecomando/remote	4 leds	€ 990,00
6294-120X70 RAL	K0629412070ECL	AISI 430	MOT. GPE838 - 275 W	telecomando/remote	4 leds	€ 1.139,00
6294-90X50 R RAL	K0629409050ECLR	AISI 430	RADIALE/RADIAL - 145 W	telecomando/remote	4 leds	€ 1.009,00
6294-120X50 R RAL	K0629412050ECLR	AISI 430	RADIALE/RADIAL - 145 W	telecomando/remote	4 leds	€ 1.083,00
6294-120X70 R RAL	K0629412070ECLR	AISI 430	RADIALE/RADIAL - 145 W	telecomando/remote	4 leds	€ 1.232,00
6294-90X50 M RAL	K0629409050ECLM	AISI 430	REMOV. GPE838- 275 W	telecomando/remote	4 leds	€ 1.080,00
6294-120X50 M RAL	K0629412050ECLM	AISI 430	REMOV. GPE838- 275 W	telecomando/remote	4 leds	€ 1.156,00
6294-120X70 M RAL	K0629412070ECLM	AISI 430	REMOV. GPE838- 275 W	telecomando/remote	4 leds	€ 1.305,00

**Accessori (non inclusi)/Accessories (not included)**

Filtro carbone Lav./Charcoal filter washable

Cassetta filtrante Long life/Filtering long life cassette

**Codice/Code**

55090025-2 (90x50)

55090028-3(120x50-120x70)

KKIT003CF

**Prezzo/Price**

€ 115,00

€ 168,00

€ 301,00



## **Cappe ad incasso/Built-in hoods**



Modello/Model	Codice/Code	Materiale/Material	Motore/Motor	Comandi/Controls	Illuminazione/Lighting	Prezzo/Price €
43-060	K0043060EXL	AISI 430	250 W	ELETTRONICA/ELECTR.	LED 2,5 W	€ 515,00
43-090	K0043090EXL	AISI 430	250 W	ELETTRONICA/ELECTR.	LED 2,5 W	€ 542,00
43-120	K00430120EXL	AISI 430	250 W	ELETTRONICA/ELECTR.	LED 2,5 W	€ 595,00

Accessori (non inclusi)/Accessories (not included)	Codice/Code	Prezzo/Price
FILTRO CARBONE/ CARBON FILTER	55046266	€ 40,00

**Note:** POSSIBLE VERSIONE PER MOTORE ESTERNO/POSSIBLE VERSION FOR EXTERNAL MOTOR





Modello/Model	Codice/Code	Materiale/Material	Motore/Motor	Comandi/Controls	Illuminazione/Lighting	Prezzo/Price €
34-60	K00434060EXL1	AISI 430	250 W	ELETTRONICA/ELECTR.	LED SPOTS 2x2,5W	€ 790,00
434-90	K00434090EXL1	AISI 430	250 W	ELETTRONICA/ELECTR.	LED SPOTS 2x2,5W	€ 815,00
434-120	K00434120EXL1	AISI 430	250 W	ELETTRONICA/ELECTR.	LED SPOTS 2x2,5W	€ 897,00

**Accessori (non inclusi)/Accessories (not included)**

FILTRO CARBONE/ CARBON FILTER

**Codice/Code**

55046757

**Prezzo/Price**

€ 32,00

**Note:**

POSSIBLE VERSION FOR EXTERNAL MOTOR





## Cappe a parete/Wall hoods



Modello/Model	Codice/Code	Materiale/Material	Motore/Motor	Comandi/Controls	Illuminazione/Lighting	Prezzo/Price €
14-120	K90014120EXL	AISI 430	275 W	ELETTR./ELECTRONIC	LED SPOTS 2,5 WATT	€ 1.229,00
14-150	K90014150EXL	AISI 430	275 W	ELETTR./ELECTRONIC	LED SPOTS 2,5 WATT	€ 1.387,00
14-180	K90014180EXL	AISI 430	275 W	ELETTR./ELECTRONIC	LED SPOTS 2,5 WATT	€ 1.632,00

**Accessori (non inclusi)/Accessories (not included)**

STARTER SET  
Filtro carbone/Charcoal filter

**Codice/Code**

K0700KIT  
55046266

**Prezzo/Price**

€ 82,00  
€ 40,00

**Note:**

POSSIBLE VERSIONE MOTORE ESTERNO E COLORI RAL - POSSIBLE VERSION FOR EXTERNAL MOTOR AND RAL COLOURS



Modello/Model	Codice/Code	Materiale/Material	Motore/Motor	Comandi/Controls	Illuminazione/Lighting	Prezzo/Price €
62-090	K0062090EXL	AISI 430	275 W	ELETTR./ELECTRONIC	LED SPOT 2,5 W	€ 890,00
62-120	K0062120EXL	AISI 430	275 W	ELETTR./ELECTRONIC	LED SPOT 2,5 W	€ 970,00
62-150	K0062150EXL	AISI 430	275 W	ELETTR./ELECTRONIC	LED SPOT 2,5 W	€ 1.180,00
62-180	K0062180EXL	AISI 430	275 W	ELETTR./ELECTRONIC	LED SPOT 2,5 W	€ 1.335,00

**Accessori (non inclusi)/Accessories (not included)**

STARTER SET  
Filtro carbone/Charcoal filter

**Codice/Code**

KEL0423KIT  
55046249

**Prezzo/Price**

€ 89,00  
€ 30,00

**Note:**  
POSSIBLE VERSIONE MOTORE ESTERNO E COLORI RAL - POSSIBLE VERSION FOR EXTERNAL MOTOR AND RAL COLOURS

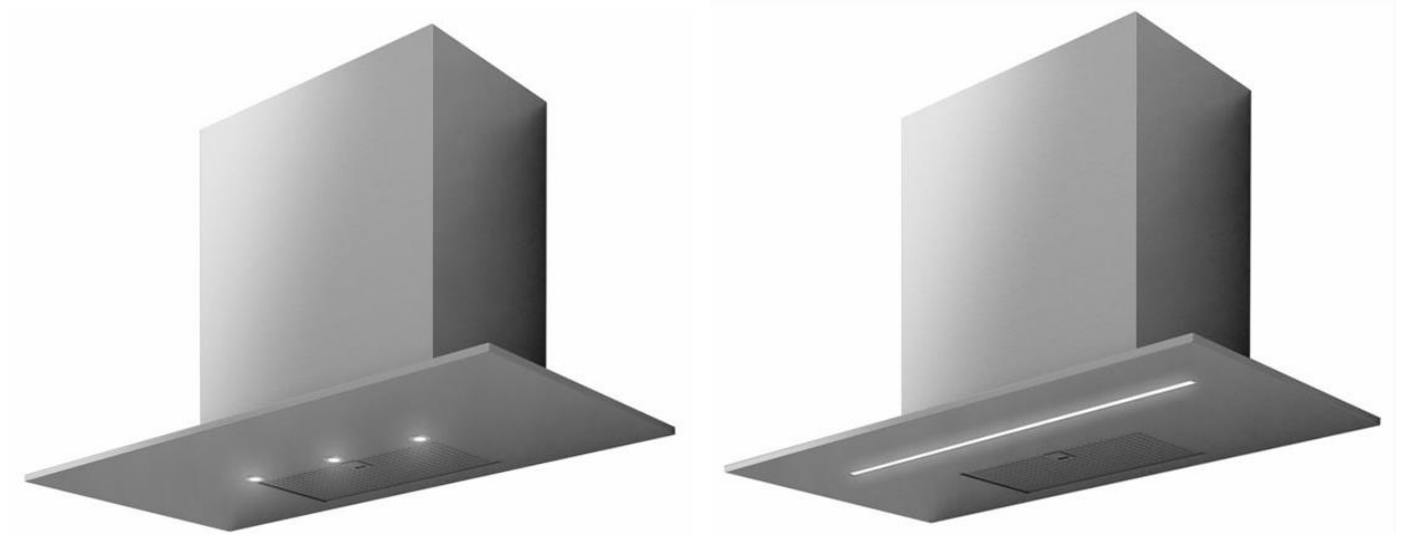

Modello/Model	Codice/Code	Materiale/Material	Motore/Motor	Comandi/Controls	Illuminazione/Lighting	Prezzo/Price €
76-90	K90076090EX	AISI 430	INTERNAL MOT. 275W	Electr./ Electronic contr.	LED SPOTS	€ 1.029,00
76-120	K90076120EX	AISI 430	INTERNAL MOT. 275W	Electr./ Electronic contr.	LED SPOTS	€ 1.061,00
76-90 BL	K90076090EXBL	AISI 430	INTERNAL MOT. 275W	Electr./ Electronic contr.	BARRA LED/LED BAR	€ 1.095,00
76-120B L	K90076120EXBL	AISI 430	INTERNAL MOT. 275W	Electr./ Electronic contr.	BARRA LED/LED BAR	€ 1.162,00

**Accessori (non inclusi)/Accessories (not included)**

Filtro Carbone/Charcoal Filter  
Kit Filtrante/Filtering Kit

**Codice/Code**

55046757  
K90076KIT

**Prezzo/Price**

€ 32,00  
€ 126,00

**Note:**

POSSIBLE VERSIONE MOTORE ESTERNO E COLORI RAL - POSSIBLE VERSION FOR EXTERNAL MOTOR AND RAL COLOURS



Modello/Model	Codice/Code	Materiale/Material	Motore/Motor	Comandi/Controls	Illuminazione/Lighting	Prezzo/Price €
95-090	K90095090EXL	AISI 430	275 W	Elett/ Electronic	LED SPOTS	€ 1.228,00
95-120	K90095120EXL	AISI 430	275 W	Elett/ Electronic	LED SPOTS	€ 1.314,00

**Accessori (non inclusi)/Accessories (not included)**

	Codice/Code	Prezzo/Price
STARTER SET 90 CM	K90095090KIT	€ 358,00
STARTER SET 120 CM	K90095120KIT	€ 408,00
Filtro Carbone/Charcoal Filter	55046757	€ 32,00

**Note:** POSSIBILE VERSIONE COLOUR E MOTORE ESTERNO - POSSIBLE VERSION EXTERNAL MOTOR AND PAINTED



Modello/Model	Codice/Code	Materiale/Material	Motore/Motor	Comandi/Controls	Illuminazione/Lighting	Prezzo/Price €
1010-90	K901010090EX	AISI 430	275 W	Elect./Electronic	LED SPOT	€ 806,00
1010-120	K901010120EX	AISI 430	275 W	Elect./Electronic	LED SPOT	€ 869,00
1010-150	K901010150EX	AISI 430	275 W	Elect./Electronic	LED SPOT	€ 994,00

**Accessori (non inclusi)/Accessories (not included)**

Filtro carbone/Charcoal filter

STARTER SET

Filtro carbone/Charcoal filter

**Codice/Code**

KEL0423KIT

55046249

**Prezzo/Price**

€ 89,00

€ 30,00

**Note:**

POSSIBILE VERSIONE COLOUR E MOTORE ESTERNO - POSSIBLE VERSION EXTERNAL MOTOR AND PAINTED





Modello/Model	Codice/Code	Materiale/Material	Motore/Motor	Comandi/Controls	Illuminazione/Lighting	Prezzo/Price €
1136-90 H. 60	K01136090EX-H60	AISI 430	275 W	ELEC./ELECTRONIC	PANN. LED/LED PANEL	€ 1.542,00
1136-90 H. 88	K01136090EX-H88	AISI 430	275 W	ELEC./ELECTRONIC	PANN. LED/LED PANEL	€ 1.554,00
1136-120 H. 60	K01136120EX-H60	AISI 430	275 W	ELEC./ELECTRONIC	PANN. LED/LED PANEL	€ 1.945,00
1136-120 H. 88	K01136120EX-H88	AISI 430	275 W	ELEC./ELECTRONIC	PANN. LED/LED PANEL	€ 1.957,00
1136-90 H. 60	K601136090EX-H60	AISI 430	EXTERNAL MOTOR	ELEC./ELECTRONIC	PANN. LED/LED PANEL	€ 1.485,00
1136-90 H. 88	K601136090EX-H88	AISI 430	EXTERNAL MOTOR	ELEC./ELECTRONIC	PANN. LED/LED PANEL	€ 1.496,00
1136-120 H. 60	K601136120EX-H60	AISI 430	EXTERNAL MOTOR	ELEC./ELECTRONIC	PANN. LED/LED PANEL	€ 1.888,00
1136-120 H. 88	K601136120EX-H88	AISI 430	EXTERNAL MOTOR	ELEC./ELECTRONIC	PANN. LED/LED PANEL	€ 1.899,00

**Accessori (non inclusi)/Accessories (not included)****Codice/Code****Prezzo/Price**

SET PANNELLI ACCIAIO/SET CLADDING KIT INOX

L.90 H. 60

€ 528,00

L.90 H. 88

€ 598,00

L.120 H. 60

€ 638,00

L.120 H. 88

€ 715,00

SET PANNELLI COLOUR/SET CLADDING KIT COLOUR  
RAL COLOURS

L.90 H. 60

€ 707,00

L.90 H. 88

€ 802,00

L.120 H. 60

€ 835,00

L.120 H. 88

€ 937,00

**Accessori (non inclusi)/Accessories (not included)****Codice/Code**

SET PANNELLI ACCIAIO/SET CLADDING KIT INOX

Vedere sopra / See above

SET PANNELLI COLOUR/SET CLADDING KIT COLOUR RAL

**Note:**

POSSIBILE VERSIONE COLOUR E MOTORE ESTERNO - POSSIBLE VERSION EXTERNAL MOTOR AND PAINTED



Modello/Model	Codice/Code	Materiale/Material	Motore/Motor	Comandi/Controls	Illuminazione/Lighting	Prezzo/Price €
1155	K01155090EX	INOX+VETRO NERO INOX+ BLACK GLASS	275 W	TOUCH	LED SPOTS	€ 1.234,00
	K01155090EC	RAL+VETRO NERO RAL+ BLACK GLASS	275 W	TOUCH	LED SPOTS	€ 1.464,00

**Accessori (non inclusi)/Accessories (not included)**

FILTRO CARBONE/CARBON FILTER

**Codice/Code**

55046266

**Prezzo/Price**

€ 40,00

**Note:**

POSSIBILE VERSIONE MOTORE ESTERNO/POSSIBLE VERSION FOR EXTERNAL MOTOR



Modello/Model	Codice/Code	Materiale/Material	Motore/Motor	Comandi/Controls	Illuminazione/Lighting	Prezzo/Price €
6267 AS	K06267075EXA	AISI 430 + VETRO+CAM 430 + GLAS+CHIMNEY	275 W- GPE838	TOUCH CONTROL	LED SPOT	€ 1.042,00
6267 FI	K06267075EXF	AISI 430 + VETRO/AISI 430 + GLAS- NO CAMINO, NO CHIMNEY	275 W- GPE700	TOUCH CONTROL	LED SPOT	€ 951,00
		versione filtrante incluso filtro carbone 55046266 filtering version included carbon filter 55046266				

**Accessori (non inclusi)/Accessories (not included)**

Filtro carbone /Charcoal Filter

**Codice/Code**

554046266

**Prezzo/Price**

€ 40,00

**Note:**

POSSIBILITA' DI FARE VERSIONE MOTORE ESTERNO / POSSIBLE WITH ALL EXTERNAL MOTORS



Modello/Model	Codice/Code	Materiale/Material	Motore/Motor	Comandi/Controls	Illuminazione/Lighting	Prezzo/Price €
6283-90	K0628309050EXL	AISI 430+VETRO/GLAS	RADIAL. 145W	Elettronica/Electronic	Led Spots	€ 1.886,00
6283-120	K0628312050EXL	AISI 430+VETRO/GLAS	RADIAL. 145W	Elettronica/Electronic	Led Spots	€ 2.242,00
Compreso filtro carbone long life Including long life carbon filter 55046232 Illuminazione led secondaria su margine vetro Secondary led lighting on the edge of the glass						€ 265,00

**Accessori /Accessories**  
Filtro Carbone/Carbon Filter

**Codice/Code**  
55046232

**Prezzo/Price**

**Note:**  
POSSIBILI COLORI RAL A RICHIESTA E VERSIONE MOTORE ESTERNO, POSSIBLE RAL COLOURS AND VERSIONS FOR EXTERNAL MOTORS



**Cappe ad isola/Island hoods**



Modello/Model	Codice/Code	Materiale/Material	Motore/Motor	Comandi/Controls	Illuminazione/Lighting	Prezzo/Price €
15-120	K90015120EXL	AISI 430	275 W	Elett. +Telec./Elec. +Rem.	LED 2,5 W	€ 1.603,00
15-150	K90015150EXL	AISI 430	275 W	Elett. +Telec./Elec. +Rem.	LED 2,5 W	€ 1.805,00
15-180	K90015180EXL	AISI 430	275 W	Elett. +Telec./Elec. +Rem.	LED 2,5 W	€ 2.064,00

**Accessori (non inclusi)/Accessories (not included)**

Kit filtrante/Filtering kit  
Filtri carboni/Charcoal Filters

**Codice/Code**

K90745KIT  
55046266

**Prezzo/Price**

€ 89,00  
€ 40,00

**Note:**

POSSIBILE VERSIONE RAL E PER MOTORI ESTERNI, POSSIBLE RAL VERSION AND FOR EXTERNAL MOTORS

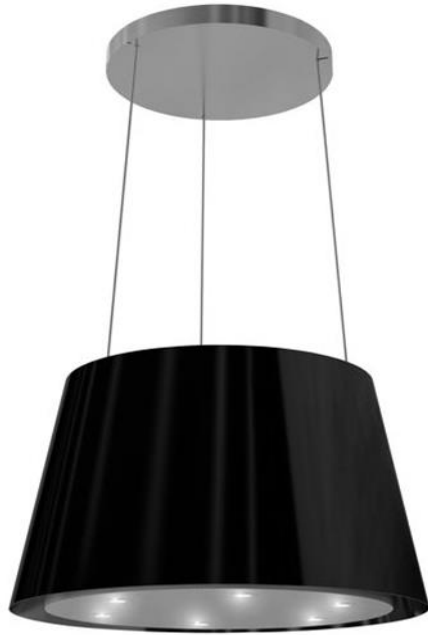

Modello/Model	Codice/Code	Materiale/Material	Motore/Motor	Comandi/Controls	Illuminazione/Lighting	Prezzo/Price €
40-55 AS	K90040055EXAS	AISI 430 + VERN/PAINT	275 W	Solo Tel./Only Remote	Led spots	€ 1.306,00
40-55 FI	K90040055EXFI	AISI 430 + VERN/PAINT	275 W	Solo Tel./Only Remote	Led spots	€ 1.306,00

La versione filtrante ha compreso il filtro carbone  
 The filtering version has included carbon filter 55046270

**Accessori (non inclusi)/Accessories (not included)**

STARTER SET  
 Filtro Carbone/Charcoal Filter

**Codice/Code**

K90047KIT  
 55046270

**Prezzo/Price**

€ 106,00  
 € 42,00

**Note:** POSSIBILE VERSIONE MOTORE ESTERNO/ POSSIBLE VERSION EXTERNAL MOTOR



Modello/Model	Codice/Code	Materiale/Material	Motore/Motor	Comandi/Controls	Illuminazione/Lighting	Prezzo/Price €
47-45 AS	K90047045EXAS	AISI 430 + VERN./PAINT.	275 W	Solo Tel./Only Remote	Led spots	€ 1.224,00
47-45 FI	K90047045EXFI	AISI 430 + VERN./PAINT.	275 W	Solo Tel./Only Remote	Led spots	€ 1.224,00

La versione filtrante ha compreso il filtro carbone  
 The filtering version has included carbon filter 55046270

Accessori (non inclusi)/Accessories (not included)	Codice/Code	Prezzo/Price
STARTER SET	K90047KIT	€ 106,00
Filtro Carbone/Charcoal Filter	55046270	€ 42,00

**Note:**  
 POSSIBILE VERSIONE MOTORE ESTERNO/ POSSIBLE VERSION EXTERNAL MOTOR





Modello/Model	Codice/Code	Materiale/Material	Motore/Motor	Comandi/Controls	Illuminazione/Lighting	Prezzo/Price €
62-90 I	K0062090EXIL	AISI 430	275 W	Elett. +Telec./Elec. +Rem.	LED SPOTS	€ 1.150,00
62-120 I	K0062120EXIL	AISI 430	275 W	Elett. +Telec./Elec. +Rem.	LED SPOTS	€ 1.250,00
62-150 I	K0062150EXIL	AISI 430	275 W	Elett. +Telec./Elec. +Rem.	LED SPOTS	€ 1.460,00
62-180 I	K0062180EXIL	AISI 430	275 W	Elett. +Telec./Elec. +Rem.	LED SPOTS	€ 1.570,00

**Accessori (non inclusi)/Accessories (not included)**

STARTER SET  
Filtro Carbone/Charcoal Filter

**Codice/Code**

K900745KIT  
55046266

**Prezzo/Price**

€ 89,00  
€ 40,00

**Note:** POSSIBILE VERSIONE MOTORE ESTERNO/ POSSIBLE VERSION EXTERNAL MOTOR



Modello/Model	Codice/Code	Materiale/Material	Motore/Motor	Comandi/Controls	Illuminazione/Lighting	Prezzo/Price €
76-90 I L H.65	K90076090EXIL65	AISI 430	275 W	Elett. +Telec./Elec. +Rem.	Led Spots	€ 1.129,00
76-90 I L H.95	K90076090EXIL95	AISI 430	275 W	Elett. +Telec./Elec. +Rem.	Led Spots	€ 1.170,00
76-90 I L H.125	K90076090EXIL125	AISI 430	275 W	Elett. +Telec./Elec. +Rem.	Led Spots	€ 1.243,00
76-120 I L H.65	K90076120EXIL65	AISI 430	275 W	Elett. +Telec./Elec. +Rem.	Led Spots	€ 1.158,00
76-120 I L H.95	K90076120EXIL95	AISI 430	275 W	Elett. +Telec./Elec. +Rem.	Led Spots	€ 1.198,00
76-120 I L H.125	K90076120EXIL125	AISI 430	275 W	Elett. +Telec./Elec. +Rem.	Led Spots	€ 1.271,00
76-150 I L H.65	K90076150EXIL65	AISI 430	275 W	Elett. +Telec./Elec. +Rem.	Led Spots	€ 1.221,00
76-150 I L H.95	K90076150EXIL95	AISI 430	275 W	Elett. +Telec./Elec. +Rem.	Led Spots	€ 1.262,00
76-150 I L H.125	K90076150EXIL125	AISI 430	275 W	Elett. +Telec./Elec. +Rem.	Led Spots	€ 1.335,00
76-90 I BL H.65	K90076090EXIBL65	AISI 430	275 W	Elett. +Telec./Elec. +Rem.	Barra Led/Led bar	€ 1.210,00
76-90 I BL H.95	K90076090EXIBL95	AISI 430	275 W	Elett. +Telec./Elec. +Rem.	Barra Led/Led bar	€ 1.250,00
76-90 I BL H.125	K90076090EXIBL125	AISI 430	275 W	Elett. +Telec./Elec. +Rem.	Barra Led/Led bar	€ 1.324,00
76-120 I BL H.65	K90076120EXIBL65	AISI 430	275 W	Elett. +Telec./Elec. +Rem.	Barra Led/Led bar	€ 1.258,00
76-120 I BL H.95	K90076120EXIBL95	AISI 430	275 W	Elett. +Telec./Elec. +Rem.	Barra Led/Led bar	€ 1.270,00
76-120 I BL H.125	K90076120EXIBL125	AISI 430	275 W	Elett. +Telec./Elec. +Rem.	Barra Led/Led bar	€ 1.371,00
76-150 I BL H.65	K90076150EXIBL65	AISI 430	275 W	Elett. +Telec./Elec. +Rem.	Barra Led/Led bar	€ 1.364,00
76-150 I BL H.95	K90076150EXIBL95	AISI 430	275 W	Elett. +Telec./Elec. +Rem.	Barra Led/Led bar	€ 1.405,00
76-150 I BL H.125	K90076150EXIBL125	AISI 430	275 W	Elett. +Telec./Elec. +Rem.	Barra Led/Led bar	€ 1.478,00

PER SOLUZIONE FILTRANTE, CON CAMINO CON FERITOIE + EUR 100  
 FOR FILTERING VERSION WITH CHIMNEY WITH SLOTS + EUR 100

#### Accessori (non inclusi)/Accessories (not included)

Filtro Carbone materassino/Mat Charcoal Filter

ATTENZIONE : IN CASO DI VERSIONE FILTRANTE LA CAPP A DEVE

ESSERE APPOSITAMENTE ORDINATA CON CAMINO FILTRANTE

ATTENTION : IN CASE OF FILTERING VERSION THE HOOD MUST BE

ORDERED SPECIFICALLY FILTERING -

#### Codice/Code

55041001

+ EUR 100,00

+ EUR 100,00

#### Prezzo/Price

€ 47,00

#### Note:

POSSIBILE VERSIONE RAL E MOTORE ESTERNO, POSSIBLE RAL VERSION AND EXTERNAL MOTOR



Modello/Model	Codice/Code	Materiale/Material	Motore/Motor	Comandi/Controls	Illuminazione/Lighting	Prezzo/Price €
85-120 H. 65	K0085120EXFI65-1	AISI 430+ VETR./GLAS	250 W	Solo Tel./Only Remote	LED 2,5 W	€ 1.512,00
85-120 H. 95	K0085120EXFI95-1	AISI 430+ VETR./GLAS	250 W	Solo Tel./Only Remote	LED 2,5 W	€ 1.531,00
85-120 H. 125	K00850120EXFI125-1	AISI 430+ VETR./GLAS	250 W	Solo Tel./Only Remote	LED 2,5 W	€ 1.555,00
85-150 H. 65	K0085150EXFI65-1	AISI 430+ VETR./GLAS	250 W	Solo Tel./Only Remote	LED 2,5 W	€ 1.699,00
85-150 H. 95	K0085150EXFI95-1	AISI 430+ VETR./GLAS	250 W	Solo Tel./Only Remote	LED 2,5 W	€ 1.723,00
85-150 H. 125	K00850150EXFI125-1	AISI 430+ VETR./GLAS	250 W	Solo Tel./Only Remote	LED 2,5 W	€ 1.742,00
85-120 H. 65	K0085120ECFI65-1	AISI 430 + VERN./PAINT	250 W	Solo Tel./Only Remote	LED 2,5 W	€ 1.891,00
85-120 H. 95	K0085120ECFI95-1	AISI 430 + VERN./PAINT	250 W	Solo Tel./Only Remote	LED 2,5 W	€ 1.910,00
85-120 H. 125	K00850120ECFI125-1	AISI 430 + VERN./PAINT	250 W	Solo Tel./Only Remote	LED 2,5 W	€ 1.934,00
85-150 H. 65	K0085150ECFI65-1	AISI 430 + VERN./PAINT	250 W	Solo Tel./Only Remote	LED 2,5 W	€ 2.102,00
85-150 H. 95	K0085150ECFI95-1	AISI 430 + VERN./PAINT	250 W	Solo Tel./Only Remote	LED 2,5 W	€ 2.126,00
85-150 H. 125	K0085150ECFI125-1	AISI 430 + VERN./PAINT	250 W	Solo Tel./Only Remote	LED 2,5 W	€ 2.146,00

RAL COLOURS

INCLUSO FILTRO CARBONE 55046244  
CARBON FILTER 55046244 INCLUDED

#### Accessori /Accessories

FILTRO CARBONE CILIND.CILINDRIC CARBON FILTER

#### Codice/Code

55046244

#### Prezzo/Price

€ 94,00

**Note:** POSSIBILE VERSIONE MOTORE ESTERNO/ POSSIBLE VERSION EXTERNAL MOTOR

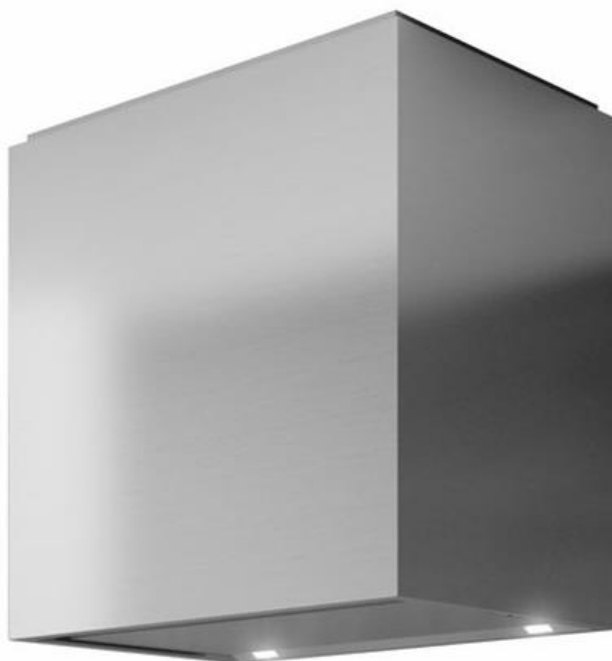

Modello/Model	Codice/Code	Materiale/Material	Motore/Motor	Comandi/Controls	Illuminazione/Lighting	Prezzo/Price €
95-090 I	K90095090EXI	AISI 430	275 W	ELEC. + REMOTE	LED SPOTS	€ 1.396,00
95-120 I	K90095120EXI	AISI 430	275 W	ELEC. + REMOTE	LED SPOTS	€ 1.470,00

**Accessori (non inclusi)/Accessories (not included)**

	Codice/Code	Prezzo/Price
STARTER SET 90 CM	K90095090KIT	€ 358,00
STARTER SET 120 CM	K90095120KIT	€ 408,00
FILTRO CARBONE/CHARCOAL FILTER	55046757	€ 32,00

**Note:** POSSIBILE VERSIONE MOTORE ESTERNO/ POSSIBLE VERSION EXTERNAL MOTOR



Modello/Model	Codice/Code	Materiale/Material	Motore/Motor	Comandi/Controls	Illuminazione/Lighting	Prezzo/Price €
1010-90 I	K901010090EXI	AISI 430	275 W	Elett. +Telec./Elec. +Rem.	LED SPOT	€ 1.099,00
1010-120 I	K901010120EXI	AISI 430	275 W	Elett. +Telec./Elec. +Rem.	LED SPOT	€ 1.190,00
1010-150 I	K901010150EXI	AISI 430	275 W	Elett. +Telec./Elec. +Rem.	LED SPOT	€ 1.296,00

### Accessori (non inclusi)/Accessories (not included)

	Codice/Code	Prezzo/Price
STARTER SET	K900745KIT	€ 89,00
FILTRO CARBONE/CHARCOAL FILTER	55046266	€ 40,00

**Note:** POSSIBILE VERSIONE MOTORE ESTERNO/ POSSIBLE VERSION EXTERNAL MOTOR

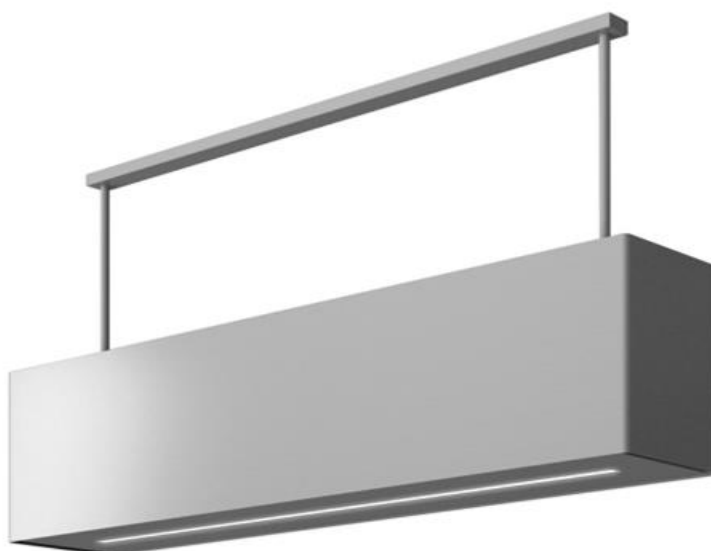

Modello/Model	Codice/Code	Materiale/Material	Motore/Motor	Comandi/Controls	Illuminazione/Lighting	Prezzo/Price €
1011-120 H65	K01011120EXFI65-1	AISI 430	250 W	Solo Tel./Only Remote	Barra Led/Led Bar	€ 1.560,00
1011-120 H95	K01011120EXFI95-1	AISI 430	250 W	Solo Tel./Only Remote	Barra Led/Led Bar	€ 1.580,00
1011-120 H125	K01011120EXFI125-1	AISI 430	250 W	Solo Tel./Only Remote	Barra Led/Led Bar	€ 1.599,00
1011-150 H65	K01011150EXFI65-1	AISI 430	250 W	Solo Tel./Only Remote	Barra Led/Led Bar	€ 1.766,00
1011-150 H95	K01011150EXFI95-1	AISI 430	250 W	Solo Tel./Only Remote	Barra Led/Led Bar	€ 1.786,00
1011-150 H125	K01011150EXFI125-1	AISI 430	250 W	Solo Tel./Only Remote	Barra Led/Led Bar	€ 1.805,00
1011-120 H65	K01011120ECFI65-1	AISI 430 + VER,/ PAINT	250 W	Solo Tel./Only Remote	Barra Led/Led Bar	€ 1.940,00
1011-120 H95	K01011120ECFI95-1	AISI 430 + VER,/ PAINT	250 W	Solo Tel./Only Remote	Barra Led/Led Bar	€ 1.959,00
1011-120 H125	K01011120ECFI125-1	AISI 430 + VER,/ PAINT	250 W	Solo Tel./Only Remote	Barra Led/Led Bar	€ 1.978,00
1011-150 H65	K01011150ECFI65-1	AISI 430 + VER,/ PAINT	250 W	Solo Tel./Only Remote	Barra Led/Led Bar	€ 2.170,00
1011-150 H95	K01011150ECFI95-1	AISI 430 + VER,/ PAINT	250 W	Solo Tel./Only Remote	Barra Led/Led Bar	€ 2.189,00
1011-150 H125	K01011150ECFI125-1	AISI 430 + VER,/ PAINT	250 W	Solo Tel./Only Remote	Barra Led/Led Bar	€ 2.208,00

INCLUSO FILTRO CARBONE 55046244  
CARBON FILTER 55046244 INCLUDED

#### Accessori /Accessories

FILTRO CARBONE CILINDRICO/CILINDRIC CARBON FILTER

#### Codice/Code

55046244

#### Prezzo/Price

€ 94,00

**Note:** POSSIBILE VERSIONE MOTORE ESTERNO/ POSSIBLE VERSION EXTERNAL MOTOR

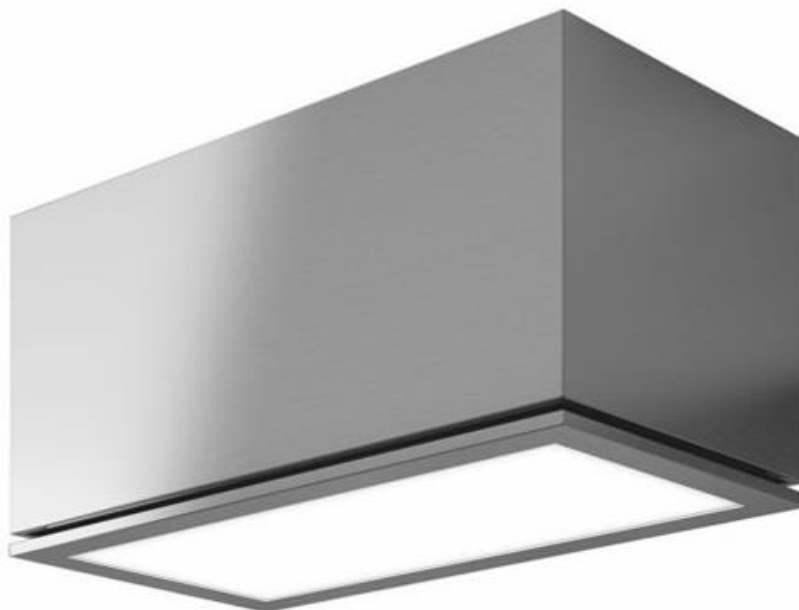

Modello/Model	Codice/Code	Materiale/Material	Motore/Motor	Comandi/Controls	Illuminazione/Lighting	Prezzo/Price €
1046-30	K01046030EX	AISI 430	275 W	Elett. +Telec./Elec. +Rem.	Pannello Led/Led Panel	€ 918,00
1046-60	K01046060EX	AISI 430	275 W	Elett. +Telec./Elec. +Rem.	Pannello Led/Led Panel	€ 1.157,00
1046-120	K01046120EX	AISI 430	275 W	Elett. +Telec./Elec. +Rem.	Pannello Led/Led Panel	€ 1.582,00
VERSIONE COLOR NON METALLIZZATO/COLOUR VERSION NON METALLIC						
1046-30	K01046030EC	AISI 430+ VERN./PAINT.	275 W	Elett. +Telec./Elec. +Rem.	Pannello Led/Led Panel	€ 1.143,00
1046-60	K01046060EC	AISI 430+ VERN./PAINT.	275 W	Elett. +Telec./Elec. +Rem.	Pannello Led/Led Panel	€ 1.428,00
1046-120	K01046120EC	AISI 430+ VERN./PAINT.	275 W	Elett. +Telec./Elec. +Rem.	Pannello Led/Led Panel	€ 1.918,00

**Accessori (non inclusi)/Accessories (not included)**

**Codice/Code**

**Prezzo/Price**

**Note:** POSSIBILE VERSIONE MOTORE ESTERNO/ POSSIBLE VERSION EXTERNAL MOTOR



Modello/Model	Codice/Code	Materiale/Material	Motore/Motor	Comandi/Controls	Illuminazione/Lighting	Prezzo/Price €
1052-90 I H 60	K901052090EX60	AISI 430	275 W	Sol. Tel./Only Remote	Barra Led/Led Bar	€ 1.725,00
1052-90 I H 90	K901052090EX90	AISI 430	275 W	Sol. Tel./Only Remote	Barra Led/Led Bar	€ 1.830,00
1052-90 I H 120	K901052090EX120	AISI 430	275 W	Sol. Tel./Only Remote	Barra Led/Led Bar	€ 1.990,00
1052-120I H 60	K901052120EX60	AISI 430	275 W	Sol. Tel./Only Remote	Barra Led/Led Bar	€ 1.872,00
1052-120 I H 90	K901052120EX90	AISI 430	275 W	Sol. Tel./Only Remote	Barra Led/Led Bar	€ 2.042,00
1052-120 I H 120	K901052120EXI120	AISI 430	275 W	Sol. Tel./Only Remote	Barra Led/Led Bar	€ 2.203,00
1052-90 I C H 60	K901052090EC60	AISI 430 +VERN./PAINT.	275 W	Sol. Tel./Only Remote	Barra Led/Led Bar	€ 2.002,00
1052-90 I C H 90	K901052090EC90	AISI 430 +VERN./PAINT.	275 W	Sol. Tel./Only Remote	Barra Led/Led Bar	€ 2.139,00
1052-90 I C H 120	K901052090EC120	AISI 430 +VERN./PAINT.	275 W	Sol. Tel./Only Remote	Barra Led/Led Bar	€ 2.329,00
1052-120I C H 60	K901052120EC60	AISI 430 +VERN./PAINT.	275 W	Sol. Tel./Only Remote	Barra Led/Led Bar	€ 2.213,00
1052-120 I C H 90	K901052120EC90	AISI 430 +VERN./PAINT.	275 W	Sol. Tel./Only Remote	Barra Led/Led Bar	€ 2.412,00
1052-120 I C H 120	K901052120EC120	AISI 430 +VERN./PAINT.	275 W	Sol. Tel./Only Remote	Barra Led/Led Bar	€ 2.618,00

### Accessori (non inclusi)/Accessories (not included)

FILTRO CARBONE/CHARCOAL FILTER

### Codice/Code

55046757

### Prezzo/Price

€ 32,00

**Note:** POSSIBILE VERSIONE MOTORE ESTERNO/ POSSIBLE VERSION EXTERNAL MOTOR





Modello/Model	Codice/Code	Materiale/Material	Motore/Motor	Comandi/Controls	Illuminazione/Lighting	Prezzo/Price €
1136-90I H. 60	K01136090EXI-H60	AISI 430	275 W	Elett. +Telec./Elec. +Rem.	Pannello Led/Led Panel	€ 1.542,00
1136-90I H. 90	K01136090EXI-H90	AISI 430	275 W	Elett. +Telec./Elec. +Rem.	Pannello Led/Led Panel	€ 1.554,00
1136-120I H. 60	K01136120EXI-H60	AISI 430	275 W	Elett. +Telec./Elec. +Rem.	Pannello Led/Led Panel	€ 1.945,00
1136-120I H. 90	K01136120EXI-H90	AISI 430	275 W	Elett. +Telec./Elec. +Rem.	Pannello Led/Led Panel	€ 1.957,00
1136-90I H. 60	K601136090EXI-H60	AISI 430	FOR EXT. MOTOR	Elett. +Telec./Elec. +Rem.	Pannello Led/Led Panel	€ 1.485,00
1136-90I H. 90	K601136090EXI-H90	AISI 430	FOR EXT. MOTOR	Elett. +Telec./Elec. +Rem.	Pannello Led/Led Panel	€ 1.496,00
1136-120I H. 60	K601136120EXI-H60	AISI 430	FOR EXT. MOTOR	Elett. +Telec./Elec. +Rem.	Pannello Led/Led Panel	€ 1.888,00
1136-120I H. 90	K601136120EXI-H90	AISI 430	FOR EXT. MOTOR	Elett. +Telec./Elec. +Rem.	Pannello Led/Led Panel	€ 1.899,00

### Accessori (non inclusi)/Accessories (not included)

SET PANNELLI ACCIAIO/SET CLADDING KIT INOX

### Codice/Code

L90 H.60

L90 H. 88

L120 H. 60

L120 H. 88

### Prezzo/Price

€ 710,00

€ 818,00

€ 823,00

€ 984,00

SET PANNELLI COLOUR/SET CLADDING KIT COLOUR

RAL VERSION NOT METALLIC

L90 H.60

L90 H. 88

L120 H. 60

L120 H. 88

€ 952,00

€ 1.103,00

€ 1.100,00

€ 1.305,00

### Accessori (non inclusi)/Accessories (not included)

SET PANNELLI ACCIAIO/SET CLADDING KIT INOX

SET PANNELLI COLOUR/SET CLADDING KIT COLOUR

### Codice/Code

vedere sopra/see above

vedere sopra/see above

### PRICE

### Note:

POSSIBILE VERSIONE MOTORE ESTERNO/POSSIBLE VERSION EXTERNAL MOTOR

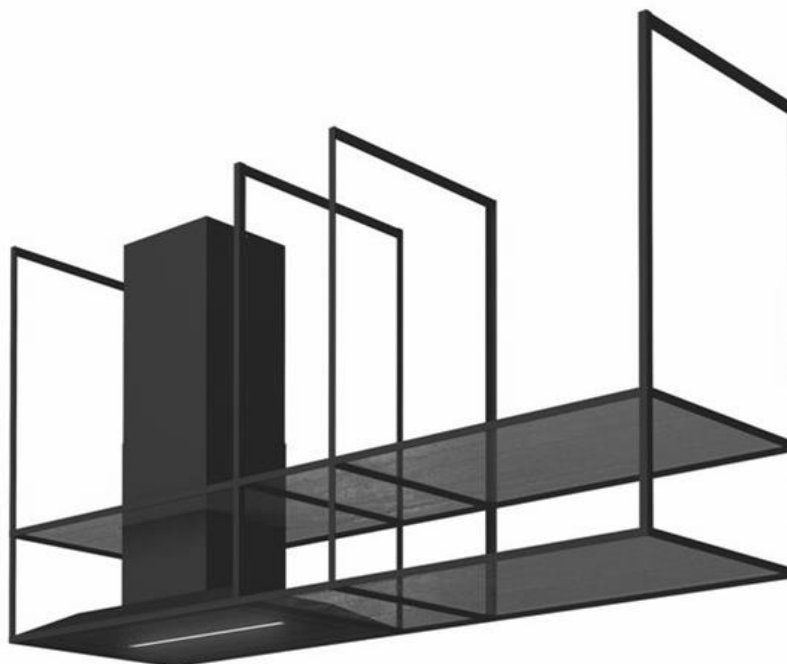

Modello/Model	Codice/Code	Materiale/Material	Motore/Motor	Comandi/Controls	Illuminazione/Lighting	Prezzo/Price €
1154-90+90 H95	K90115409090EXI95	AISI 430	275 W	Solo Tel./Only Remote	Barra Led/Led bar	€ 3.280,00
1154-90+90 H125	K90115409090EXI125	AISI 430	275 W	Solo Tel./Only Remote	Barra Led/Led bar	€ 3.350,00
1154-90+120 H95	K901154090120EXI95	AISI 430	275 W	Solo Tel./Only Remote	Barra Led/Led bar	€ 3.300,00
1154-90+120 H125	K901154090120EXI125	AISI 430	275 W	Solo Tel./Only Remote	Barra Led/Led bar	€ 3.390,00
1154-90+150 H95	K901154090150EXI95	AISI 430	275 W	Solo Tel./Only Remote	Barra Led/Led bar	€ 3.345,00
1154-90+150 H125	K901154090150EXI125	AISI 430	275 W	Solo Tel./Only Remote	Barra Led/Led bar	€ 3.430,00
1154-120+90 H95	K90115412090EXI95	AISI 430	275 W	Solo Tel./Only Remote	Barra Led/Led bar	€ 3.460,00
1154-120+90 H125	K90115412090EXI125	AISI 430	275 W	Solo Tel./Only Remote	Barra Led/Led bar	€ 3.530,00
1154-120+120 H95	K901154120120EXI95	AISI 430	275 W	Solo Tel./Only Remote	Barra Led/Led bar	€ 3.485,00
1154-120+120 H125	K901154120120EXI125	AISI 430	275 W	Solo Tel./Only Remote	Barra Led/Led bar	€ 3.575,00
1154-120+150 H95	K901154120150EXI95	AISI 430	275 W	Solo Tel./Only Remote	Barra Led/Led bar	€ 3.525,00
1154-120+150 H125	K901154120150EXI125	AISI 430	275 W	Solo Tel./Only Remote	Barra Led/Led bar	€ 3.615,00

**ATTENZIONE : NELLA VERSIONE INOX LA PARTE TUBOLARE RIMANE VERNICIATA. ATTENTION IN THE INOX VERSION THE TUBULAR PART STAYS PAINTED**

VERSIONE COLOR NON METALLIZZATI/COLOUR VERSION NOT METALLIC

1154-90+90 H95	K90115409090ECI95	AISI 430	275 W	Solo Tel./Only Remote	Barra Led/Led bar	€ 3.535,00
1154-90+90 H125	K90115409090ECI125	AISI 430	275 W	Solo Tel./Only Remote	Barra Led/Led bar	€ 3.605,00
1154-90+120 H95	K901154090120ECI95	AISI 430	275 W	Solo Tel./Only Remote	Barra Led/Led bar	€ 3.560,00
1154-90+120 H125	K901154090120ECI125	AISI 430	275 W	Solo Tel./Only Remote	Barra Led/Led bar	€ 3.645,00
1154-90+150 H95	K901154090150ECI95	AISI 430	275 W	Solo Tel./Only Remote	Barra Led/Led bar	€ 3.600,00
1154-90+150 H125	K901154090150ECI125	AISI 430	275 W	Solo Tel./Only Remote	Barra Led/Led bar	€ 3.685,00
1154-120+90 H95	K90115412090ECI95	AISI 430	275 W	Solo Tel./Only Remote	Barra Led/Led bar	€ 3.740,00
1154-120+90 H125	K90115412090ECI125	AISI 430	275 W	Solo Tel./Only Remote	Barra Led/Led bar	€ 3.810,00
1154-120+120 H95	K901154120120ECI95	AISI 430	275 W	Solo Tel./Only Remote	Barra Led/Led bar	€ 3.765,00
1154-120+120 H125	K901154120120ECI125	AISI 430	275 W	Solo Tel./Only Remote	Barra Led/Led bar	€ 3.850,00
1154-120+150 H95	K901154120150ECI95	AISI 430	275 W	Solo Tel./Only Remote	Barra Led/Led bar	€ 3.805,00
1154-120+150 H125	K901154120150ECI125	AISI 430	275 W	Solo Tel./Only Remote	Barra Led/Led bar	€ 3.890,00

#### Accessori (non inclusi)/Accessories (not included)

	Codice/Code	Prezzo/Price
STARTER SET	K900745KIT	€ 89,00
FILTRO CARBONE/CARBON FILTER	55046266	€ 40,00

#### Note:

POSSIBLE VERSIONE MOTORE ESTERNO/POSSIBLE VERSION EXTERNAL MOTOR



Modello/Model	Codice/Code	Materiale/Material	Motore/Motor	Comandi/Controls	Illuminazione/Lighting	Prezzo/Price €
6002-90X60	K0600209060EXL	AISI 430 + CILINDRIC	250	Elett. +Telec./Elec. +Rem.	Led spots	€ 1.337,00
6002-120X70	K06002120070EXL	AISI 430 + CILINDRIC	250	Elett. +Telec./Elec. +Rem.	Led spots	€ 1.490,00
6002-90X60	K0600209060EXLP	AISI 430 + PLASMA	250	Elett. +Telec./Elec. +Rem.	Led spots	€ 1.845,00
6002-120X70	K06002120070EXLP	AISI 430 + PLASMA	250	Elett. +Telec./Elec. +Rem.	Led spots	€ 1.998,00
6002-90X60	K0600209060EXLV	AISI 430+ VET.GLA + CIL.	250	Elett. +Telec./Elec. +Rem.	Led spots	€ 1.485,00
6002-120X70	K06002120070EXLV	AISI 430+ VET.GLA + CIL.	250	Elett. +Telec./Elec. +Rem.	Led spots	€ 1.707,00
6002-90X60	K0600209060EXLVP	AISI 430+ VET.GLA + PL	250	Elett. +Telec./Elec. +Rem.	Led spots	€ 1.994,00
6002-120X70	K06002120070EXVLP	AISI 430+ VET.GLA + PL	250	Elett. +Telec./Elec. +Rem.	Led spots	€ 2.216,00

I PREZZI INCLUDONO FILTRO CILINDRICO O PLASMA

THE PRICES ARE INCLUDING CYLINDRIC CARBON FILTER OR PLASMA

VERSIONE VERNICATA COLORI NON METALLICI/PAINTED VERSION N ON METALLIC COLOURS

6002-90X60 VERN	K0600209060ECL	AISI 430 + PAINT + CIL	250	Elett. +Telec./Elec. +Rem.	Led spots	€ 1.724,00
6002-120X70 VERN	K06002120070ECL	AISI 430 + PAINT + CIL	250	Elett. +Telec./Elec. +Rem.	Led spots	€ 1.907,00
6002-90X60 VERN	K0600209060ECLP	AISI 430 + PAINT + PL.	250	Elett. +Telec./Elec. +Rem.	Led spots	€ 2.233,00
6002-120X70 VERN	K06002120070ECLP	AISI 430 + PAINT + PL.	250	Elett. +Telec./Elec. +Rem.	Led spots	€ 2.416,00
6002-90X60 VERN	K0600209060ECLV	AISI 430/PAINT/GL. CIL	250	Elett. +Telec./Elec. +Rem.	Led spots	€ 1.858,00
6002-120X70 VERN	K06002120070ECLV	AISI 430/PAINT/GL. CIL	250	Elett. +Telec./Elec. +Rem.	Led spots	€ 2.107,00
FIM 6002-90X60 VERN	K0600209060ECLVP	AISI 430/PAINT/GL. PL	250	Elett. +Telec./Elec. +Rem.	Led spots	€ 2.366,00
FIM 6002-120X70 VERN	K06002120070ECLVP	AISI 430/PAINT/GL. PL	250	Elett. +Telec./Elec. +Rem.	Led spots	€ 2.616,00

I PREZZI INCLUDONO FILTRO CILINDRICO O PLASMA

THE PRICES ARE INCLUDING CYLINDRIC CARBON FILTER OR PLASMA

#### Accessori /Accessories

Filtro carbone cilindrico/Cylindric charcoal filter  
PLASMA FILTER

#### Codice/Code

55046244  
R55046203

#### Prezzo/Price

€ 94,00  
€ 645,00

#### Note:

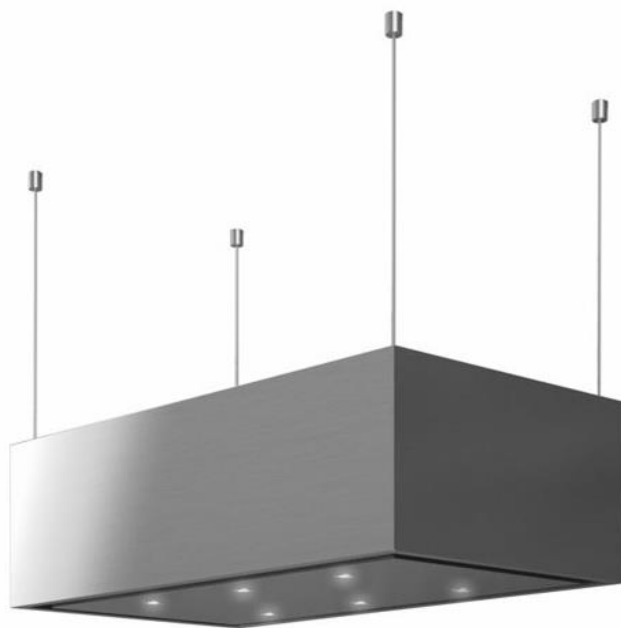

Modello/Model	Codice/Code	Materiale/Material	Motore/Motor	Comandi/Controls	Illuminazione/Lighting	Prezzo/Price €
6002-90X50 T	K0600209050EXLT	AISI 430+ CILIND.	250	Elett. +Telec./Elec. +Rem.	Led spots	€ 1.522,00
6002-90X50 PT	K0600209050EXLPT	AISI 430+ PLASMA	250	Elett. +Telec./Elec. +Rem.	Led spots	€ 2.030,00

I PREZZI INCLUDONO FILTRO CILINDRICO O PLASMA

THE PRICES ARE INCLUDING CYLINDRIC CARBON FILTER OR PLASMA

VERSIONE VERNICATA COLORI NON METALLICI/PAINTED VERSION N ON METALLIC COLOURS

6002-90X50 T	K0600209050ECLT	AISI 430+ PAINT + CIL	250 W	Elett. +Telec./Elec. +Rem.	Led spots	€ 1.848,00
6002-90X50 T	K0600209050ECLPT	AISI 430+ PAINT + PL	250 W	Elett. +Telec./Elec. +Rem.	Led spots	€ 2.357,00

I PREZZI INCLUDONO FILTRO CILINDRICO O PLASMA

THE PRICES ARE INCLUDING CYLINDRIC CARBON FILTER OR PLASMA

#### Accessori /Accessories

Filtro carbone cilindrico/Cylindric charcoal filter  
PLASMA FILTER

#### Codice/Code

55046244  
R55046203

#### Prezzo/Price

€ 94,00  
€ 645,00

#### Note:



Modello/Model	Codice/Code	Materiale/Material	Motore/Motor	Comandi/Controls	Illuminazione/Lighting	Prezzo/Price €
6073-90X60	K0607309060EX	AISI 430	250 W	Elett. +Telec./Elec. +Rem.	Barra Led/Led bar	€ 1.205,00
6073-120x60	K0607312060EX	AISI 430	250 W	Elett. +Telec./Elec. +Rem.	Barra Led/Led bar	€ 1.520,00

I PREZZI INCLUDONO FILTRO CILINDRICO 55046244

THE PRICES ARE INCLUDING CYLINDRIC CARBON FILTER 55046244

#### Accessori /Accessories

Filtro carbone cilindrico- Cilindric carbon filter

#### Codice/Code

55046244

#### Prezzo/Price

€ 94,00

#### Note:

POSSIBLE VERSION FOR EXTERNAL MOTOR

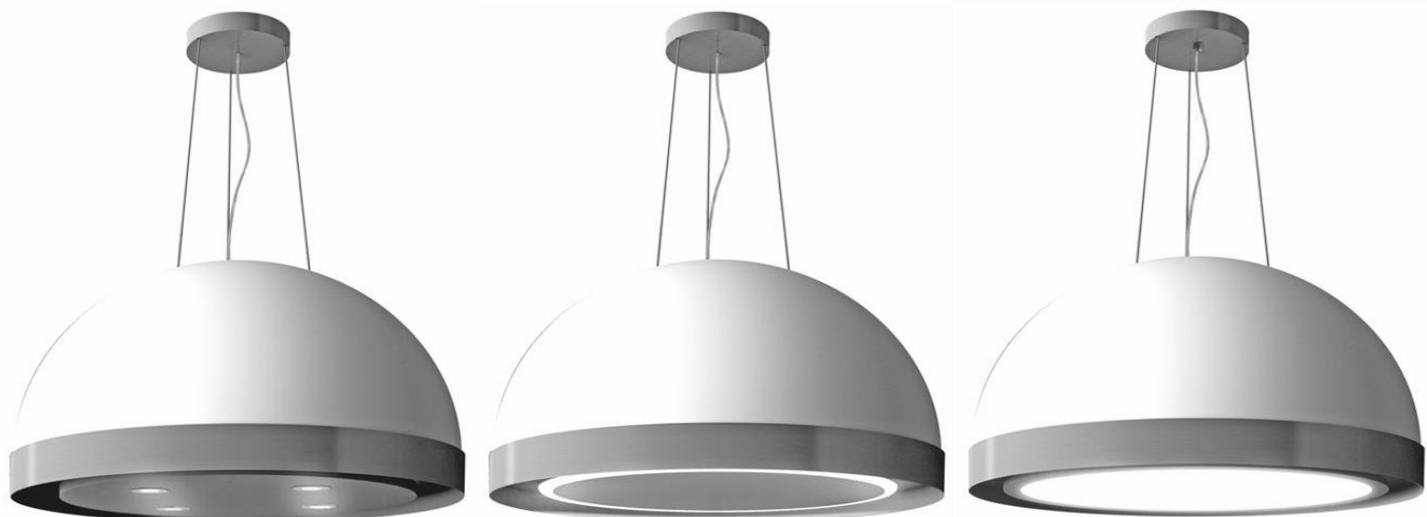

Modello/Model	Codice/Code	Materiale/Material	Motore/Motor	Comandi/Controls	Illuminazione/Lighting	Prezzo/Price €
6167-90 L	K06167090EXLFI	AISI 430+ SFERA VERNIC. AISI 430+PAINTED BOWL	275 W	Solo Tel./Only Remote	Led Spots	€ 1.966,00
6167-90 BL	K06167090EXBLFI	AISI 430+ SFERA VERNIC. AISI 430+PAINTED BOWL	275 W	Solo Tel./Only Remote	Led ring	€ 2.243,00
6168-90 LED PANEL	K06167090EXPLFI	AISI 430+ SFERA VERNIC. AISI 430+PAINTED BOWL	275 W	Solo Tel./Only Remote	Led Panel	€ 2.370,00

I PREZZI INCLUDONO FILTRO CILINDRICO 55046244

THE PRICES ARE INCLUDING CYLINDRIC CARBON FILTER 55046244

ATTENZIONE : I PREZZI SONO PER COLORI RAL NON METALLIZZATI

ATTENTION : PRICES FOR RAL COLOURS NOT METALLIC

#### Accessori /Accessories

Filtro Carbone cilindrico/Cilindric carbon filter

#### Codice/Code

55046244

#### Prezzo/Price

€ 94,00

#### Note:



Modello/Model	Codice/Code	Materiale/Material	Motore/Motor	Comandi/Controls	Illuminazione/Lighting	Prezzo/Price €
6281	K06281090EXL	AISI 430	145 W	sol. Telec./only remote	LED PANEL	€ 2.620,00
	K06281090ECL	AISI 430 + PAINTING ( RAL COLOURS )	145 W	sol. Telec./only remote	LED PANEL	€ 2.940,00
ONLY FILTERING VERSION POSSIBLE						
INCLUDING CARBON FILTER - 55046266-2						

**Accessori ( inclusi)/Accessories (included)**  
CARBON FILTER

**Codice/Code**  
55046266-2

**Prezzo/Price**  
€ 80,00

**Note:**



Modello/Model	Codice/Code	Materiale/Material	Motore/Motor	Comandi/Controls	Illuminazione/Lighting	Prezzo/Price €
6281 M	K06281090EXLM	AISI 430	145 W	Solo Tel./Only Rem.	LED PANEL	€ 3.460,00
	K06281090ECLM	AISI 430 + PAINTING ( RAL COLOURS )	145 W	Solo Tel./Only Rem.	LED PANEL	€ 3.780,00
ONLY FILTERING VERSION POSSIBLE INCLUDING CARBON FILTER - 55046266-2						

**Accessori ( inclusi)/Accessories (included)**  
CARBON FILTER

**Codice/Code**  
55046266-2

**Prezzo/Price**  
€ 80,00

**Note:**



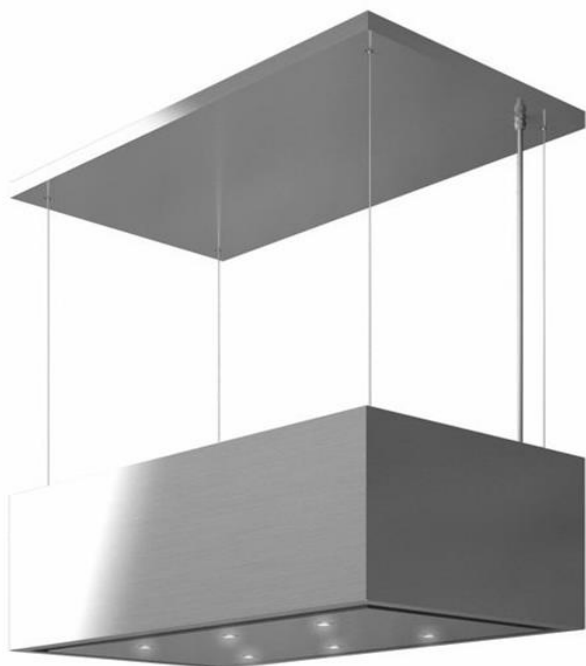

Modello/Model	Codice/Code	Materiale/Material	Motore/Motor	Comandi/Controls	Illuminazione/Lighting	Prezzo/Price €
FIM 6286	K0628609050EXL	AISI 430+ CILINDR.	250 W	Elett. +Telec./Elec. +Rem.	Led spots	€ 2.780,00
FIM 6286	K0628609050EXPL	AISI 430+ PLASMA	250 W	Elett. +Telec./Elec. +Rem.	Led spots	€ 3.298,00
FIM 6286	K0628609050ECL	AISI 430+ VERN+CILINDR.	250 W	Elett. +Telec./Elec. +Rem.	Led spots	€ 3.157,00
FIM 6286	K0628609050ECPL	AISI 430+ VERN+PLASMA	250 W	Elett. +Telec./Elec. +Rem.	Led spots	€ 3.675,00
FIM 6286	K0628609050EXLP	AISI 430+ CILINDR.	250 W	Elett. +Telec./Elec. +Rem.	Pannello Led/Led Panel	€ 3.090,00
FIM 6286	K0628609050EXPLP	AISI 430+ PLASMA	250 W	Elett. +Telec./Elec. +Rem.	Pannello Led/Led Panel	€ 3.608,00
FIM 6286	K0628609050ECLP	AISI 430+ VERN+CILINDR.	250 W	Elett. +Telec./Elec. +Rem.	Pannello Led/Led Panel	€ 3.467,00
FIM 6286	K0628609050ECPLP	AISI 430+ VERN+PLASMA	250 W	Elett. +Telec./Elec. +Rem.	Pannello Led/Led Panel	€ 3.985,00

I PREZZI INCLUDONO FILTRO CILINDRICO O PLASMA

THE PRICES ARE INCLUDING CYLINDRIC CARBON FILTER OR PLASMA

#### Accessori/Accessories

Filtro carbone cilindrico/Cylindric charcoal filter  
PLASMA FILTER

#### Codice/Code

55046244  
R55046217

#### Prezzo/Price

€ 94,00  
€ 705,00

#### Note:



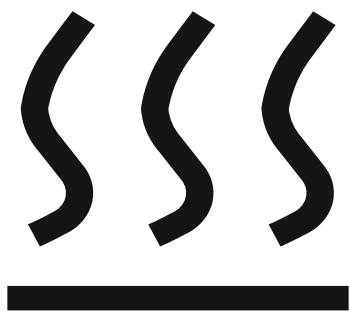

**Piani ad induzione/Induction hobs**



Modello/Model	Codice/Code	Materiale/Material	Motore/Motor	Comandi/Controls	Illuminazione/Lighting	Prezzo/Price €
FIM 4001	80400742	VETRO NERO BLACK GLASS		MULTISLIDER TOUCH CONTROL		€ 1.452,00

**Note:**

MODELLO DISPONIBILE SOLO PER ABBINAMENTO A CAPPA DA PIANO 6195 O 1156 - MODEL AVAILABLE JUST FOR COUPLING WITH 6195 OR 1156



Modello/Model	Codice/Code	Materiale/Material	Motore/Motor	Comandi/Controls	Illuminazione/Lighting	Prezzo/Price €
FIM 4002	80400743	VETRO NERO BLACK GLASS		MULTISLIDER TOUCH CONTROL		€ 1.899,00

**Note:** PIANI PER COMANDARE CAPPE IN ABBINAMENTO DA ACQUISTARE INSIEME : HOBBS TO CONTROL HOODS TO BE PURCHASED TOGETHER



Modello/Model	Codice/Code	Materiale/Material	Motore/Motor	Comandi/Controls	Illuminazione/Lighting	Prezzo/Price €
FIM 4003	80400744	VETRO NERO BLACK GLASS		Multi slider touch control		€ 1.723,00

**Note:** PIANI PER CAPPRA WD 41- HOB FOR BASE HOOD WD 41



Modello/Model	Codice/Code	Materiale/Material	Motore/Motor	Comandi/Controls	illuminazione/Lighting	Prezzo/Price €
FIM 4004	80400741	VETRO NERO BLACK GLASS		Multislider touch control		€ 887,00

**Note:**  
PIANI PER COMANDARE CAPPE IN ABBINAMENTO DA ACQUISTARE INSIEME : HOBS TO CONTROL HOODS TO BE PURCHASED TOGETHER





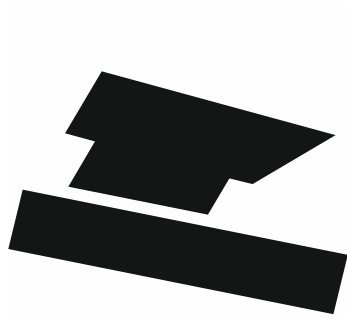

## **Motori remoti/Remote motors**



Modello/Model	Codice/Code	Materiale/Material	Motore/Motor	Comandi/Controls	Illuminazione/Lighting	Prezzo/Price €
25	K30025CEVC	AISI 304	450 W			€ 786,00

PREZZO COMPRENDE 5 MT DI CAVO  
 PRICE INCLUDING 5 MT CABLE

**Accessori (non inclusi)/Accessories (not included)**

CAVO 5 M/5 MT CABLE  
 CAVO 10 M/10 MT CABLE  
 CAVO 20 M /20 MT CABLE

**Codice/Code**

AK2600055  
 AK2600059  
 AK2600060

**Prezzo/Price**

€ 72,00  
 € 104,00  
 € 181,00

**Note:**



Modello/Model	Codice/Code	Materiale/Material	Motore/Motor	Comandi/Controls	Illuminazione/Lighting	Prezzo/Price €
27 PREZZO COMPRENDE 5 MT DI CAVO PRICE INCLUDING 5 MT CABLE	K0027CEIC	Lamiera ferro verniciata Painted metal Sheet	450 W			€ 662,00

**Accessori (non inclusi)/Accessories (not included)**

CAVO 5 M/5 MT CABLE  
CAVO 10 M/10 MT CABLE  
CAVO 20 M /20 MT CABLE

**Codice/Code**

AK2600055  
AK2600059  
AK2600060

**Prezzo/Price**

€ 72,00  
€ 104,00  
€ 181,00

**Note:**



Modello/Model	Codice/Code	Materiale/Material	Motore/Motor	Comandi/Controls	Illuminazione/Lighting	Prezzo/Price €
MURO/WALL 636	K0636CEVC	AISI 304	190 W			€ 633,00
TETTO/ROOF FIM 636	K0636CEEC	AISI 304	190 W			€ 633,00
TETTO PIANO /FLT R.636	K0636CEKIT	AISI 304	190 W			€ 798,00

PREZZO COMPRENDE 5 MT DI CAVO  
PRICE INCLUDING 5 MT CABLE

#### Accessori (non inclusi)/Accessories (not included)

CAVO 5 M/5 MT CABLE  
CAVO 10 M/10 MT CABLE  
CAVO 20 M/20 MT CABLE

#### Codice/Code

AK2600055  
AK2600059  
AK2600060

#### Prezzo/Price

€ 72,00  
€ 104,00  
€ 181,00

#### Note:

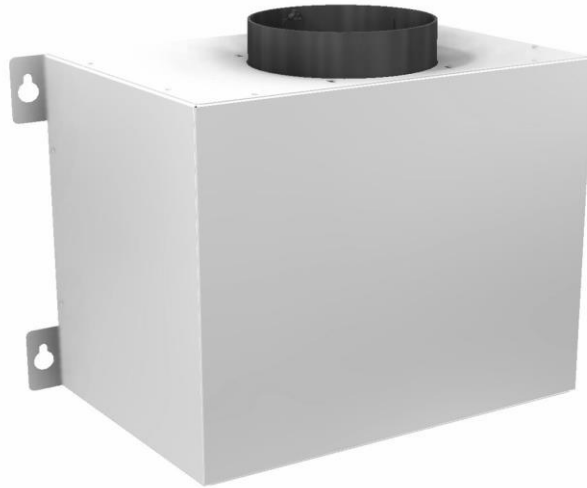

Modello/Model	Codice/Code	Materiale/Material	Motore/Motor	Comandi/Controls	Illuminazione/Lighting	Prezzo/Price €
639	K0639CEICHE	Lamiera ferro verniciata Painted metal sheet	275 W			€ 346,00

PREZZO COMPRENDE 5 MT DI CAVO  
PRICE INCLUDING 5 MT CABLE

**Accessori (non inclusi)/Accessories (not included)**

CAVO 5 M/5 MT CABLE  
CAVO 10 M/10 MT CABLE  
CAVO 20 M /20 MT CABLE

**Codice/Code**

AK2600055  
AK2600059  
AK2600060

**Prezzo/Price**

€ 72,00  
€ 104,00  
€ 181,00

**Note:**



Modello/Model	Codice/Code	Materiale/Material	Motore/Motor	Comandi/Controls	Illuminazione/Lighting	Prezzo/Price €
FIM 694	K0694CEIC	Lamiera ferro verniciata Painted metal sheet	140 W			€ 534,00

PREZZO COMPRENDE 5 MT DI CAVO  
PRICE INCLUDING 5 MT CABLE

**Accessori (non inclusi)/Accessories (not included)**

CAVO 5 M/5 MT CABLE  
CAVO 10 M/10 MT CABLE  
CAVO 20 M /20 MT CABLE

**Codice/Code**

AK2600055  
AK2600059  
AK2600060

**Prezzo/Price**

€ 72,00  
€ 104,00  
€ 181,00

**Note:**



Modello/Model	Codice/Code	Materiale/Material	Motore/Motor	Comandi/Controls	illuminazione/Lighting	Prezzo/Price €
697	K0697CEVC	AISI 304	275 W			€ 578,00
697	K0697CEVC1					€ 546,00

PREZZO COMPRENDE 5 MT DI CAVO

PRICE INCLUDING 5 MT CABLE

**Accessori (non inclusi)/Accessories (not included)**

CAVO 5 M/5 MT CABLE  
CAVO 10 M/10 MT CABLE  
CAVO 20 M /20 MT CABLE

**Codice/Code**

AK2600055  
AK2600059  
AK2600060

**Prezzo/Price**

€ 72,00  
€ 104,00  
€ 181,00

**Note:**

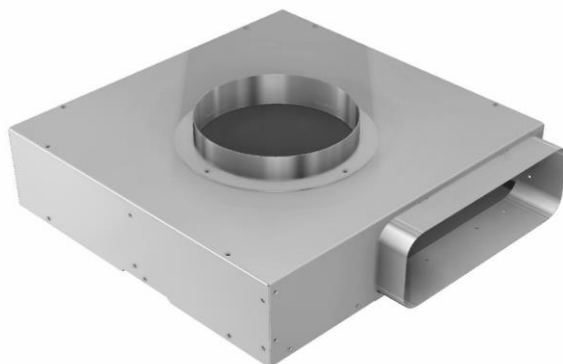

Modello/Model	Codice/Code	Materiale/Material	Motore/Motor	Comandi/Controls	Illuminazione/Lighting	Prezzo/Price €
FIM 6149	K06149CEIC	AISI 430	145 W			€ 465,00
	CON 5 MT CAVO / WITH 5 MT CABLE					
	K06149CEI	AISI 430	145 W			€ 412,00
	SENZA CAVO/ NO CABLE					

**Accessori (non inclusi)/Accessories (not included)**

CAVO 5 M/5 MT CABLE  
 CAVO 10 M/10 MT CABLE  
 CAVO 20 M /20 MT CABLE

**Codice/Code**

AK2600055  
 AK2600059  
 AK2600060

**Prezzo/Price**

€ 72,00  
 € 104,00  
 € 181,00

**Note:**



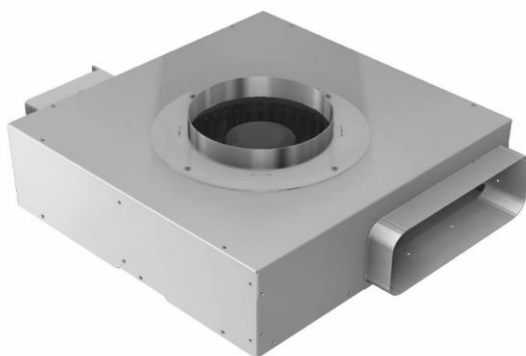

Modello/Model	Codice/Code	Materiale/Material	Motore/Motor	Comandi/Controls	Illuminazione/Lighting	Prezzo/Price €
FIM 6153	K06153CEIC	AISI 430	190 W			€ 507,00
	CON 5 MT DI CAVO/WITH 5 MT CABLE					
	K06153CEI	AISI 430	190 W			€ 455,00
	SENZA CAVO/ NO CABLE					

**Accessori (non inclusi)/Accessories (not included)**

CAVO 5 M/5 MT CABLE  
 CAVO 10 M/10 MT CABLE  
 CAVO 20 M /20 MT CABLE

**Codice/Code**

AK2600055  
 AK2600059  
 AK2600060

**Prezzo/Price**

€ 72,00  
 € 104,00  
 € 181,00

**Note:**



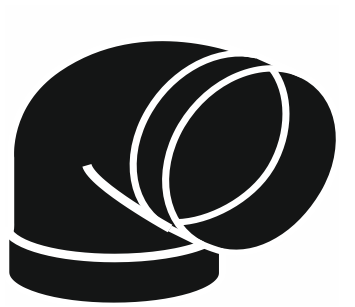

## **Accessori/Accessories**

# Filtro al plasma/Plasma filter

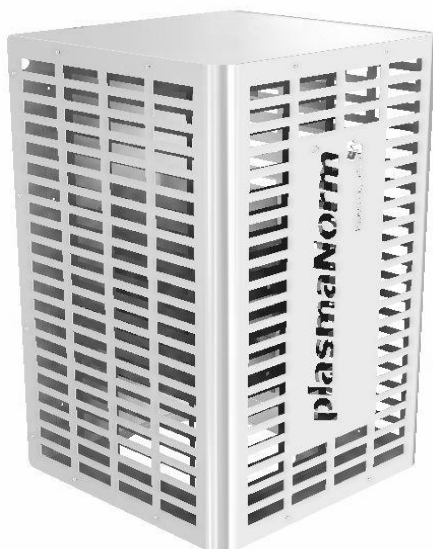

Modello/Model	Codice/Code	Materiale/Material	Motore/Motor	Comandi/Controls	Illuminazione/Lighting	Prezzo/Price €
R55046203		AISI 430				€ 645,00
R55046204	CON PRESSOSTATO ( WITH SENSOR )	AISI 430				€ 705,00

**Note:**



Modello/Model	Codice/Code	Materiale/Material	Motore/Motor	Comandi/Controls	Illuminazione/Lighting	Prezzo/Price €
KKIT003CF	FILTERING KIT					€ 301,00

#### Accessori inclusi / Accessories included

Filtro carbone/ Charcoal Filter  
Curva circolare 90 ° 150 mm/Circular Curve 90 ° 150 mm

#### Codice/Code

55046243  
06011035

€ 26,00  
€ 30,00

#### Note:

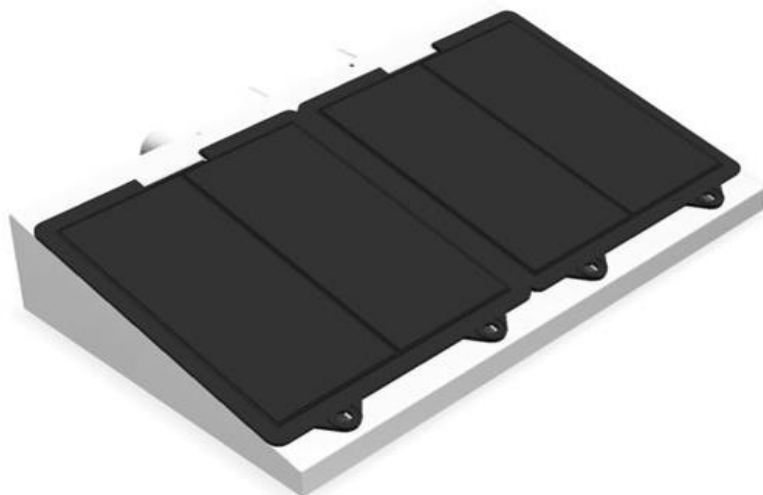

Modello/Model	Codice/Code	Materiale/Material	Motore/Motor	Comandi/Controls	Illuminazione/Lighting	Prezzo/Price €
FIM 6060	K06060KIT					€ 165,00

**Accessori ( inclusi)/Accessories ( included)**  
Filtro carbone rettangolare/Rectangular carbon filter

**Codice/Code**  
55046266 ( 2 pcs )

Price Unit.  
€ 40,00

**Note:**

# Accessori di uscita aria/Air duct accessories

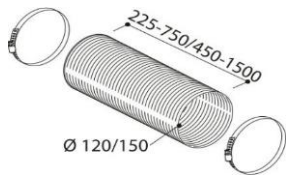

Descrizione/Description	Codice/Code	Prezzo/Price €
Kit tubo corrugato 225-750 mm + fascette Ø 120 mm/Extendable hose 225-750 mm + clamps Ø 120 mm	AK2600036	€ 30,00
Kit tubo corrugato 450-1500 mm + fascette Ø 120 mm/Extendable hose 450-1500 mm + clamps Ø 120 mm	AK2600037	€ 32,00
Kit tubo corrugato 225-750 mm + fascette Ø 150 mm/Extendable hose 225-750 + clamps Ø 150 mm	AK2600038	€ 31,00
Kit tubo corrugato 450-1500 mm + fascette Ø 150 mm/Extendable hose 450-1500 + clamps Ø 150 mm	AK2600039	€ 35,00

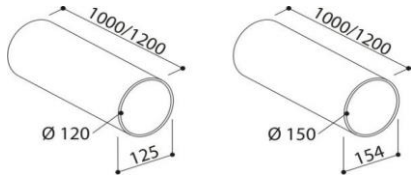

Descrizione/Description	Codice/Code	Prezzo/Price €
Tubo circolare Ø 125x1000 mm/Circular pipe Ø 125x1000 mm	06011045	€ 28,00
Tubo circolare Ø 125x1200 mm/Circular pipe Ø 125x1200 mm	06011046	€ 31,00
Tubo circolare Ø 150x1000 mm/Circular pipe Ø 150x1000 mm	06011032	€ 39,00
Tubo circolare Ø 150x1200 mm/Circular pipe Ø 150x1200 mm	06011033	€ 45,00

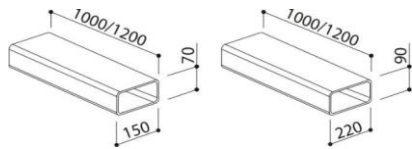

Descrizione/Description	Codice/Code	Prezzo/Price €
Tubo rettangolare 150x70x1000 mm/Rectangular pipe 150x70x1000 mm	06011043	€ 29,00
Tubo rettangolare 150x70x1200 mm/Rectangular pipe 150x70x1200 mm	06011044	€ 34,00
Tubo rettangolare 220x90x1000 mm/Rectangular pipe 220x90x1000 mm	06011030	€ 46,00
Tubo rettangolare 220x90x1200 mm/Rectangular pipe 220x90x1200 mm	06011031	€ 55,00

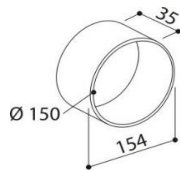

Descrizione/Description	Codice/Code	Prezzo/Price €
Giunzione circolare Ø 150x35 mm/Circular junction Ø 150x35 mm	09010138	€ 16,00

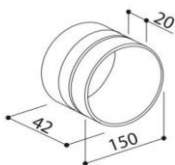
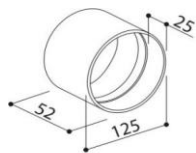

Descrizione/Description	Codice/Code	Prezzo/Price €
Giunzione circolare Ø 125 mm/Circular junction Ø 125 mm	06011047	€ 15,00
Giunzione circolare Ø 150 mm/Circular junction Ø 150 mm	06011034	€ 19,00

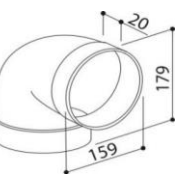
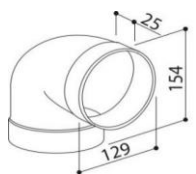

Descrizione/Description	Codice/Code	Prezzo/Price €
Curva circolare 90° Ø 125 mm/Circular curve 90° Ø 125 mm	06011048	€ 23,00
Curva circolare 90° Ø 150 mm/Circular curve 90° Ø 150 mm	06011035	€ 30,00

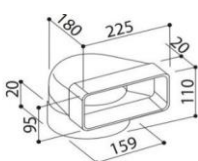
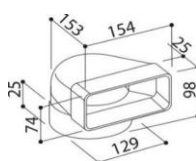

Descrizione/Description	Codice/Code	Prezzo/Price €
Curva circolare-rettangolare Ø 125-150x70 mm/Circular-rectangular curve Ø 125-150x70 mm	06011049	€ 19,00
Curva circolare-rettangolare Ø 150-220x90 mm/Circular-rectangular curve Ø 150-220x90 mm	06011036	€ 24,00

# Accessori di uscita aria / Air duct accessories

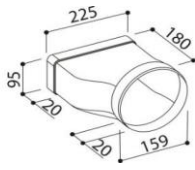
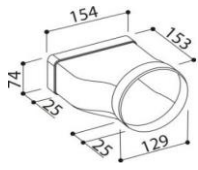

Descrizione/Description	Codice/Code	Prezzo/Price €
Giunzione circolare-rettangolare Ø 125-150x70 mm/Circular-rectangular junction Ø 125-150x70 mm	06011050	€ 18,00
Giunzione circolare-rettangolare Ø 150-220x90 mm/Circular-rectangular junction Ø 150-220x90 mm	06011037	€ 25,00

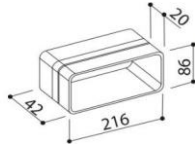
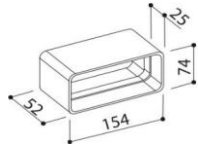

Descrizione/Description	Codice/Code	Prezzo/Price €
Giunzione rettangolare 150x70 mm/Rectangular junction 150x70 mm	06011051	€ 15,00
Giunzione rettangolare 220x90 mm/Rectangular junction 220x90 mm	06011038	€ 20,00

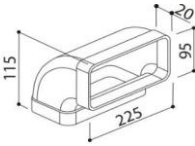
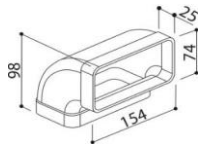

Descrizione/Description	Codice/Code	Prezzo/Price €
Curva rettangolare 90° 150x70 mm verticale/Rectangular curve 90° 150x70 mm vertical	06011052	€ 18,00
Curva rettangolare 90° 220x90 mm verticale/Rectangular curve 90° 220x90 mm vertical	06011039	€ 23,00

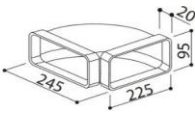
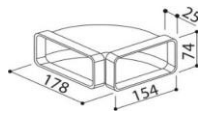

Descrizione/Description	Codice/Code	Prezzo/Price €
Curva rettangolare 90° 150x70 mm orizzontale/Rectangular curve 90° 150x70 mm horizontal	06011053	€ 20,00
Curva rettangolare 90° 220x90 mm orizzontale/Rectangular curve 90° 220x90 mm horizontal	06011040	€ 28,00

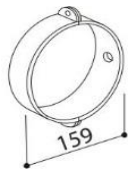
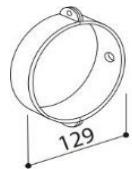

Descrizione/Description	Codice/Code	Prezzo/Price €
2 staffe fermatubo circolari Ø 125 mm/2 circular brackets to fix Ø 125 mm	06011055	€ 21,00
2 staffe fermatubo circolari Ø 150 mm/2 circular brackets to fix Ø 150 mm	06011042	€ 23,00

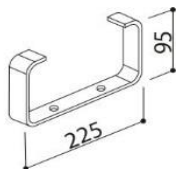
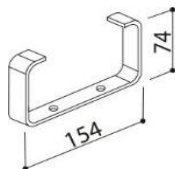

Descrizione/Description	Codice/Code	Prezzo/Price €
2 staffe fermatubo rettangolari 150x70 mm/2 rectangular brackets to fix 150x70 mm	06011054	€ 19,00
2 staffe fermatubo rettangolari 220x90 mm/2 rectangular brackets to fix 220x90 mm	06011041	€ 20,00





## **SIL FIM srl**

Via Fontedamo, 26  
60035 Jesi (AN) ITALY  
T. +39 0731 61591  
F. +39 0731 606107  
[informa@fimjesi.com](mailto:informa@fimjesi.com)  
[www.fimweb.it](http://www.fimweb.it)