

magne+olab
CREA IL TUO SPAZIO

magne+olab
CREA IL TUO SPAZIO

Esperienza, design ed innovazione made in Italy
per cucine e living funzionali,
in armonia con ogni stile e arredamento.

La soluzione elegante e intelligente
per cucine nuove, ammodernamenti e ristrutturazioni.

Experience, design and innovation made in Italy
at the service of functional kitchens and living spaces
harmonising with every style and decor.

Smart and elegant solutions for renewing,
renovate or simply modernise your kitchen.



INDICE - INDEX	5
INFO - INFO	6
VERSIONI - VERSIONS	20
VETRO LUCIDO - GLOSSY GLASS	24
VETRO OPACO - MATT GLASS	38
HPL - HPL	46
GRES - GRES	60
COMPOSIZIONE DUETTO - DUETTO COMBINATION	74
ACCENSIONE SMART MOVING - SMART MOVING IGNITION	76
DISPOSITIVO EMERGENZA HELPY LIGHT - HELPY LIGHT EMERGENCY DEVICE	78
È-SENZA CAPPА INTEGRATA - È-SENZA INTEGRATED HOOD	80
PARTNERSHIP - PARTNERSHIP	84
MATERIALI E FINITURE - MATERIALS AND FINISHES	85
INFO TECNICHE - TECHNICAL INFO	88
ACCESSORI - ACCESSORIES	90

Magnetolab:
innovazione e personalità in cucina.

Magnetolab è un sistema di soluzioni innovative, pratiche, dinamiche ed ergonomiche destinate a personalizzare e organizzare la cucina.

Magnetolab si compone di uno schienale magnetico realizzabile in un'ampia varietà di materiali sul quale vengono applicati accessori di uso quotidiano che possono essere spostati o staccati in modo facile, immediato e senza necessità di fori, sfruttando le proprietà del magnetismo.

Questo consente una rivoluzionaria dinamicità ed un'estrema personalizzazione dello spazio tra top e pensile a seconda dell'uso, dei diversi momenti della giornata e delle esigenze di ognuno.

Magnetolab:
innovation and personality in the kitchen.

Magnetolab is a system of innovative, practical, dynamic and ergonomic solution designed to customise and organise your kitchen.

Magnetolab consists of a magnetic backplash, available in an incredibly wide selection of materials- Everyday accessories – by virtue of magnetism – may be attached, moved, and detached at whims and easily with no need of holes or other supports.

The result is a defiant dynamism and extreme personalisation of the space between the top and the wall kitchen units, according to the needs of the moment.



Accessori magnetici

Tutti gli accessori Magnetolab hanno all'interno uno speciale magnete che ne consente lo spostamento da una zona all'altra dello schienale.

Magnetic accessories

All Magnetolab accessories have a special magnet inside that allows them to be moved from one area of the surface to another.

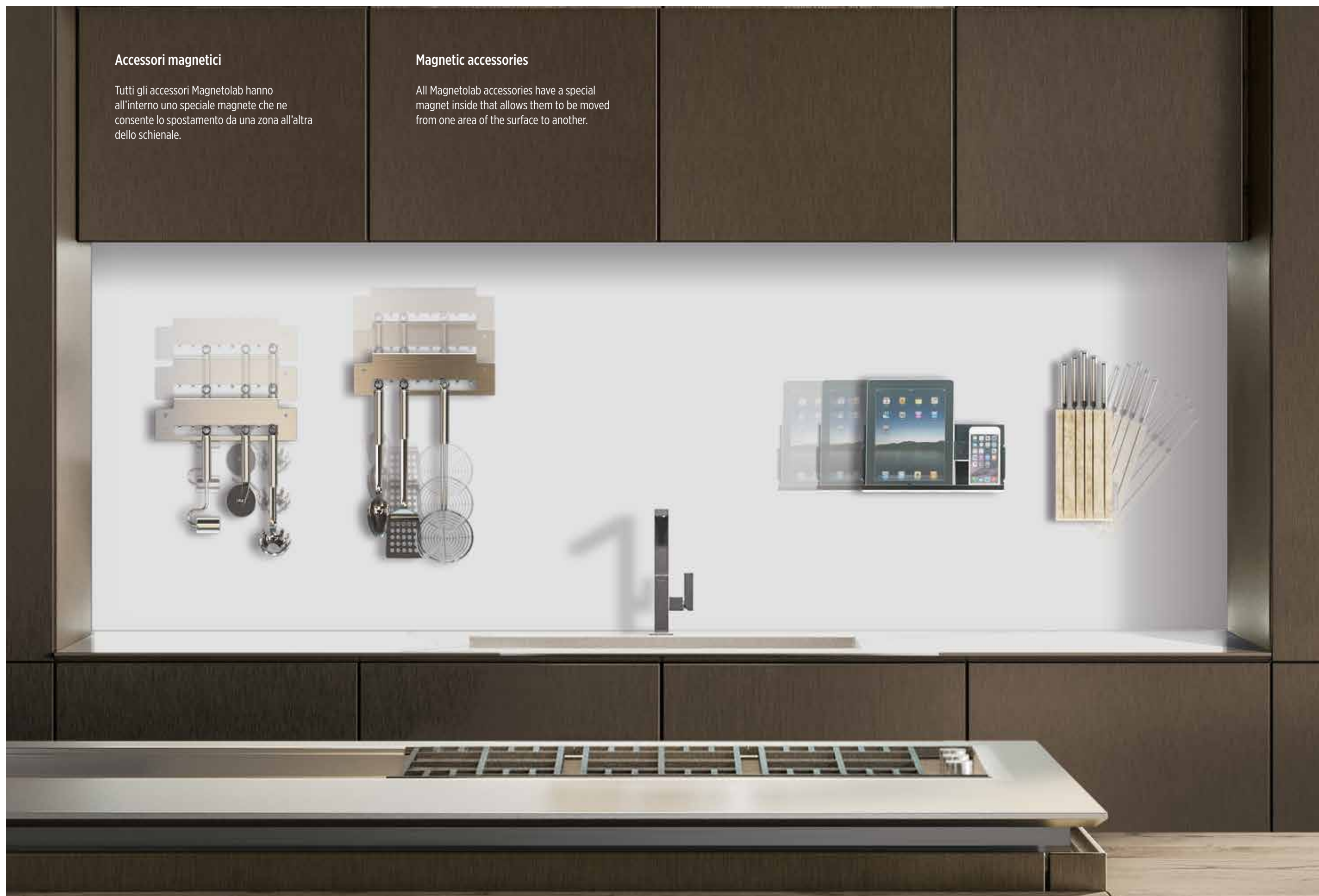

Con il sistema Magnetolab
la cucina diventa il tuo spazio
unico, personale e funzionale,
in continua evoluzione.

Magnetolab system transforms your kitchen
into a unique, customized and functional
space that never stops evolving.

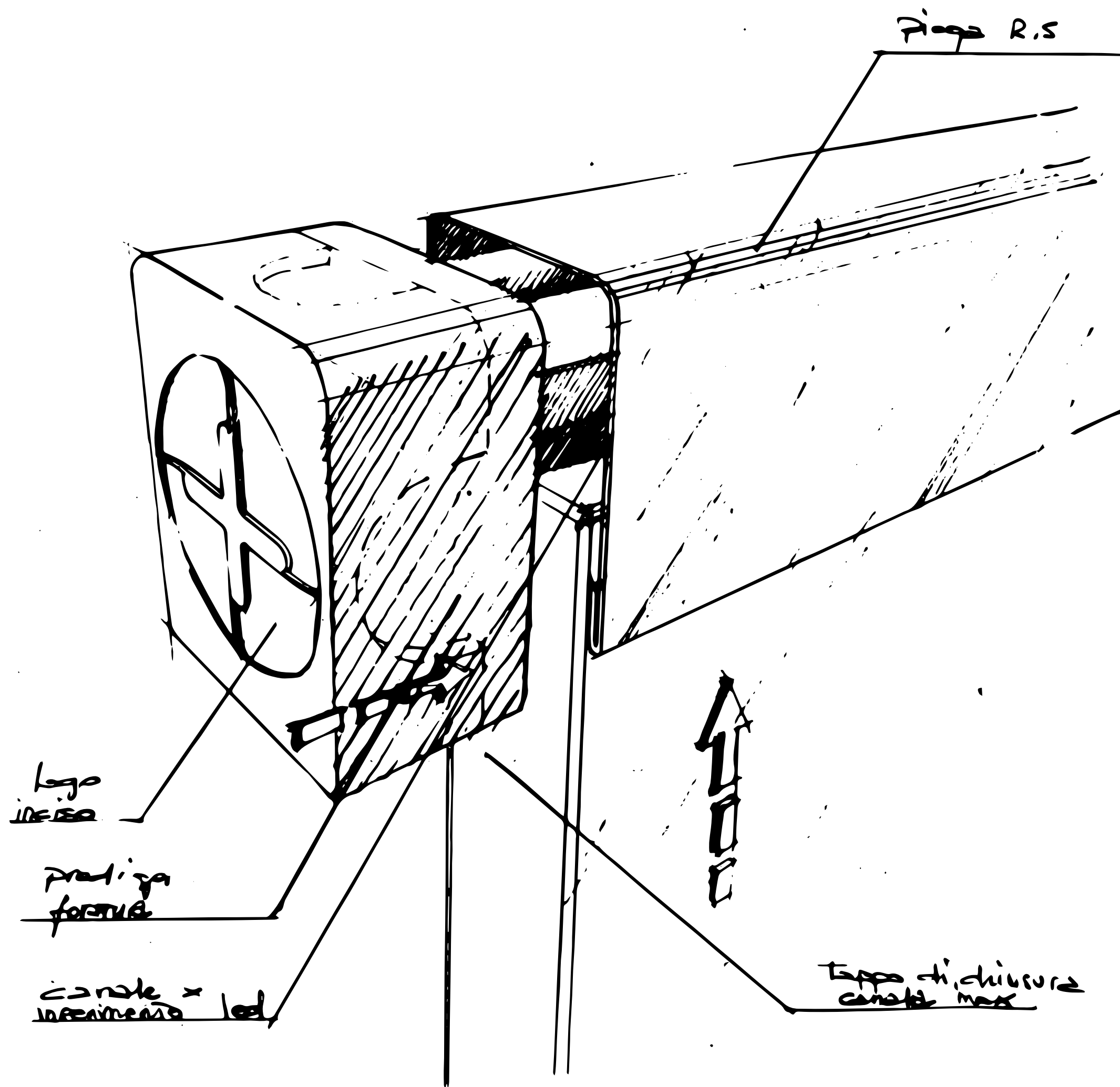



Magnetolab è il risultato dell'incontro tra l'innovazione, il design e l'artigianalità made in Italy.

Ogni particolare del progetto Magnetolab è stato sviluppato e messo a punto testandolo nel tempo, grazie alla disponibilità di tecnologie, spazi, know-how e tanta determinazione.

La nostra forza è il controllo globale del processo produttivo: dal design, alla selezione dei materiali, alla produzione del pannello, all'assemblaggio, alle fasi di test.

Grazie ad importanti partnership con aziende leader di settore riusciamo a garantire un'altissima qualità dei materiali e delle finiture dei diversi pannelli, ad oggi adottati dai migliori marchi di cucine presenti sul mercato.



Magnetolab is where innovation encounters the made in Italy design and craftsmanship.

The Magnetolab project has been developed and fine-tuned in every minute detail over time, employing the latest technologies and due to the availability of the right spaces and know-how and, above all, sheer determination.

Our strength lies in the total control of the production process: from the design, to the selection of materials, from the production of the panel, to the assembly and testing.

Thanks to important partnerships with leading companies in the sector, we are able to guarantee the highest quality of the materials and finishing of every single panel. Our backsplashes figure in the best kitchen brands on the market.

INNOVATIVO

Magnetolab rivoluziona completamente il concetto della zona lavoro in cucina rendendola dinamica, igienica, versatile e attraente.

LUMINOSO

Con Magnetolab lo schienale della cucina diventa una superficie luminosa che rende più funzionale il piano di lavoro; a seconda del materiale scelto, è possibile ottenere un'illuminazione diffusa o radente, azionabile anche con l'innovativo sistema di accensione gestuale Smart Moving.

FACILE DA INSTALLARE

Magnetolab è applicabile con semplicità e può essere modellato e forato per prese o altro.

COMPLETO, VERSATILE ED IN CONTINUA EVOLUZIONE

Magnetolab dispone di una gamma di accessori magnetici (porta spezie, porta mestoli, porta tablet, porta scottex, porta capsule da caffè, mensole, cappa aspirante e molti altri.), con diverse finiture (acciaio INOX, bianco opaco, titanio e nero piombo).

Il pannello magnetico è realizzabile in diversi materiali e colori per ogni stile di arredamento.



Magnetolab vetro opaco luminoso, colore creta, con porta coltelli in legno, porta tablet e barra appendi e aggancia in finitura inox.

Magnetolab lighting matt glass Creta color backsplash with beechwood knife block and tablet holder and ladle holder with hooks with stainless steel finishing.



INNOVATIVE

Magnetolab completely refashions the very concept of the kitchen working area, translating it into a dynamic, hygienic, versatile, and inviting place.

BRIGHT

Magnetolab converts the kitchen backsplash into an upscale illuminating surface for a more functional worktop. Depending on the material selected, lighting may be diffused or grazing and may also be operated by the innovative Smart Moving system.

EASY TO INSTALL

Magnetolab is not only easy to install, but it can be shaped according to needs and drilled for sockets or other requirements.

COMPLETE, VERSATILE AND CONTINUOUSLY EVOLVING

Magnetolab features a wide range of magnetic accessories that come in numerous finishing, that is stainless steel, matt white, titanium, lead.

Magnetolab's magnetic accessories include spice holder, ladle holder, tablet holder, paper towel holder, coffee capsule holder, shelves, extractor hood, and many others.

The magnetic backsplashes are available in a selection of materials and colours to blend in with every style of furniture.

COME FUNZIONA?

Il sistema consiste nella stratificazione della "placca" Magnetolab con i diversi materiali con cui è possibile realizzare lo schienale. La placca, che si fissa alla parete grazie a specifiche rondelle magnetiche, permette il posizionamento e lo spostamento degli accessori magnetici su tutta la superficie.

Le rondelle possono essere spessorate per compensare irregolarità dei muri o risolvere angoli in fuori squadra.

HOW DOES IT WORK?

The system consists in stratifying the selected backsplash material over the Magnetolab "plate". The plate is fixed to the wall via specifically designed magnets, keeping accessories in place or moving them along the entire surface.

Washers thickness may vary to compensate for wall irregularities or out-of-square corners.

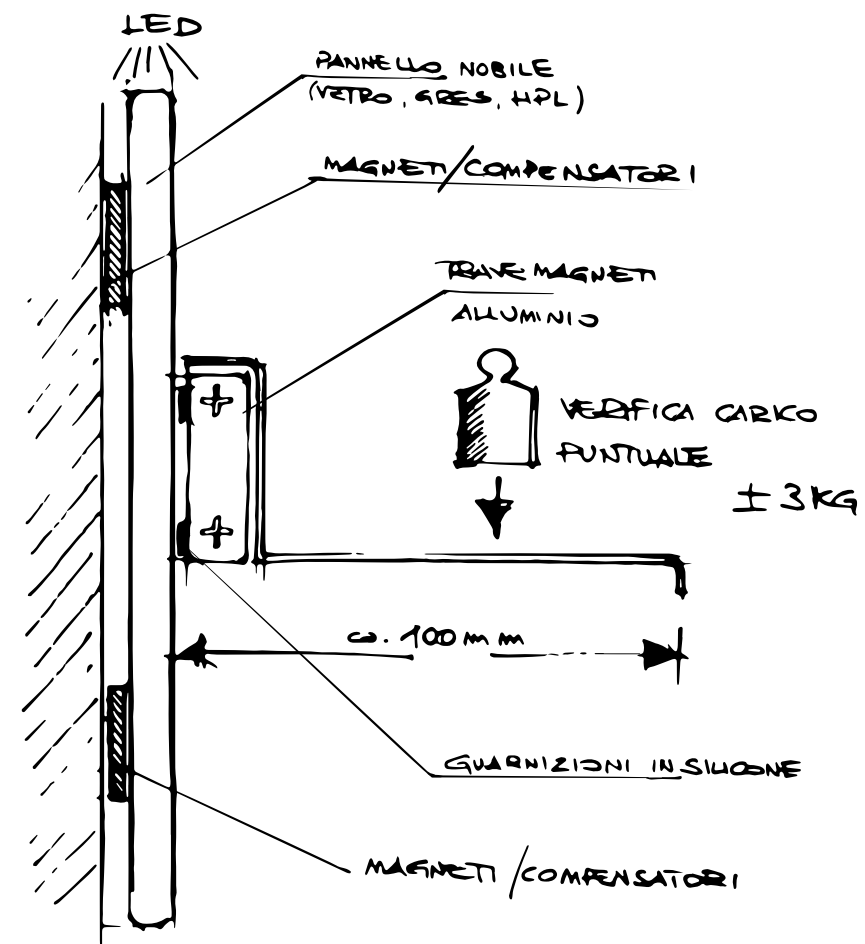

VERSIONI

Lo schienale Magnetolab è realizzabile in:

VETRO LUCIDO ANCHE IN VERSIONE LUMINOSA

Con spessore minimo 12 mm temperato, retroverniciato in colorazioni di serie o in tutti i colori del catalogo RAL.

Dimensioni massime L 3.200 mm, H 1.200 mm.

Superficie scrivibile con pennarelli per lavagne.

VETRO OPACO ANCHE IN VERSIONE LUMINOSA

Con spessore minimo 12 mm temperato, retroverniciato in colorazioni di serie o in tutti i colori del catalogo RAL.

Dimensioni massime L 3.200 mm, H 1.200 mm.

Superficie scrivibile con gessi o pennarelli gesso liquido.

HPL

Con spessore minimo 12 mm in numerose varianti di colore e finiture.

GRES

Con spessore minimo 9 mm nei colori di serie.

VETRO LUCIDO

GLOSSY GLASS



VETRO OPACO

MATT GLASS



VERSIONS

Magnetolab backsplashes can be made of:

GLOSSY GLASS - BRIGHT VERSION AVAILABLE

12 mm minimum thickness tempered glass;
backpainted in standard colours or in the colours of the RAL catalogue.
Maximum dimensions: 3,200 mm L, 1,200 mm H.
Surface writable with whiteboard markers.

MATT GLASS - BRIGHT VERSION AVAILABLE

12 mm minimum thickness tempered glass;
backpainted in standard colours or in the colours of the RAL catalogue.
Maximum dimensions L 3,200 mm, H 1,200 mm.
Surface writable with chalks or liquid chalk markers.

HPL

12 mm minimum thickness of 12 mm. Many variations of colours and finishing are available.

GRES

9 mm minimum thickness. Available in standard colours.

HPL

HPL



GRES

GRES



VETRO LUCIDO
GLOSSY GLASS





IL PANNELLO IN VETRO E LUCE: IL CUORE DI MAGNETOLAB

In questa soluzione lo schienale della cucina diventa una superficie luminosa che rende più funzionale il piano di lavoro. L'illuminazione con LED ad alta luminosità, con regolatore di intensità, è disponibile sia in versione integrata, sia in versione radente. Il vetro è temperato per resistere agli urti e agli sbalzi di temperatura prodotti dalle cotture.

THE GLASS AND LIGHT BACKSPLASH: THE "HEART & SOUL" OF MAGNETOLAB

This solution transforms the kitchen backsplash into a bright and illuminating surface flooding the worktop with an interrupted source of light. The LED lighting is supplied with intensity regulator and is available in both the built-in and grazing versions. The glass is tempered to withstand the impacts and temperature changes that occur during cooking.



Magnetolab vetro lucido luminoso colore a campione.

Magnetolab lighting glossy glass backsplash.



Magnetolab vetro lucido luminoso colore a campione con porta tablet e mensola in finitura titanio.



Magnetolab lighting glossy glass backsplash with tablet holder and shell with stainless steel finishing.



Magnetolab vetro lucido luminoso bianco con mensola, porta rotolo, porta spezie, porta tablet e oliera in finitura inox e porta coltelli in legno.

Magnetolab white lighting glossy glass backsplash, shelf, roll holder, spice holder, tablet holder and oil and vinegar jar holder with stainless steel finishing and beechwood knife block.



Magnetolab vetro lucido luminoso bianco con porta tablet, porta spezie, mensola e barra appendi e aggancia in finitura inox e ceppo porta coltelli in legno.

Magnetolab white lighting glossy glass backsplash, tablet holder, spice holder, ladle holder and shelf with stainless steel finishing, and beechwood knife block.



Magnetolab vetro lucido colore bianco, con porta rotolo + barra appendi e aggancia in finitura inox. - Magnetolab lighting glossy white colour glass backsplash, kitchen roll and ladle holder with stainless steel finishing.



VETRO OPACO
MATT GLASS





Magnetolab vetro opaco colore creta con illuminazione LED radente, con porta capsule Nespresso, mensola, porta spezie e porta mestoli in finitura inox e ceppo porta coltelli in legno.

Magnetolab Creta matt glass backsplash with grazing LED lighting, Nespresso capsule holder, shell, spice holder and ladle holder with stainless steel finishing and beechwood knife block.

Magnetolab, in tutte le versioni, è forabile in qualsiasi posizione per l'inserimento di prese o rubinetti.

All versions of Magnetolab can be shaped according to needs and drilled for sockets or taps.

Smart Moving è il sistema di regolazione gestuale della luminosità del pannello Magnetolab. Applicabile su tutte le versioni.

Smart Moving is the hand operated dimmer system that regulates the brightness of Magnetolab backsplash panels. Available for all versions.



Magnetolab vetro opaco colore creta con illuminazione LED radente, con porta mestoli e porta spezie in acciaio.

Magnetolab Creta matt glass backsplash with grazing LED lighting, ladle holder with stainless steel finishing and beechwood knife block.

VETRO OPACO



Magnetolab vetro opaco luminoso con ceppo porta coltelli in legno, porta tablet e oliera in finitura inox. - Magnetolab lighting matt glass with beechwood knife block, tablet holder and steel oil and vinegar jars holder with stainless steel finishing.

HPL

HPL





Magnetolab HPL nero opaco con mensola, porta spezie, porta mestoli e porta tablet in finitura inox.

Magnetolab matt black HPL backsplash, shelf, spice holder, ladle holder and tablet holder with stainless steel finishing.



Magnetolab HPL nero opaco con mensola, porta spezie, porta mestoli e porta tablet in finitura inox.

Magnetolab matt black HPL backsplash, shelf, spice holder, ladle holder and tablet holder with stainless steel finishing.



Magnetolab HPL Alabastro grey con ceppo porta coltelli in legno e barra appendi e aggancia finitura titanio e miscelatore integrato Moony satinato di Newform. Magnetolab vetro nero lucido con porta tablet e mensola in finitura titanio.

Magnetolab Alabastro grey HPL backsplash, beechwood knife block, ladle holder with hooks with titanium finishing and Newform matt Moony mixer. Magnetolab black glossy glass, tablet holder and shelf with titanium finishing.



Magnetolab HPL Alabastro grey con ceppo porta coltelli in legno, barra appendi e aggancia e miscelatore integrato Moony satinato di Newform. Magnetolab Alabastro grey HPL backsplash with beechwood knife block, ladle holder with hooks with titanium finishing and Newform Moony satin mixer.

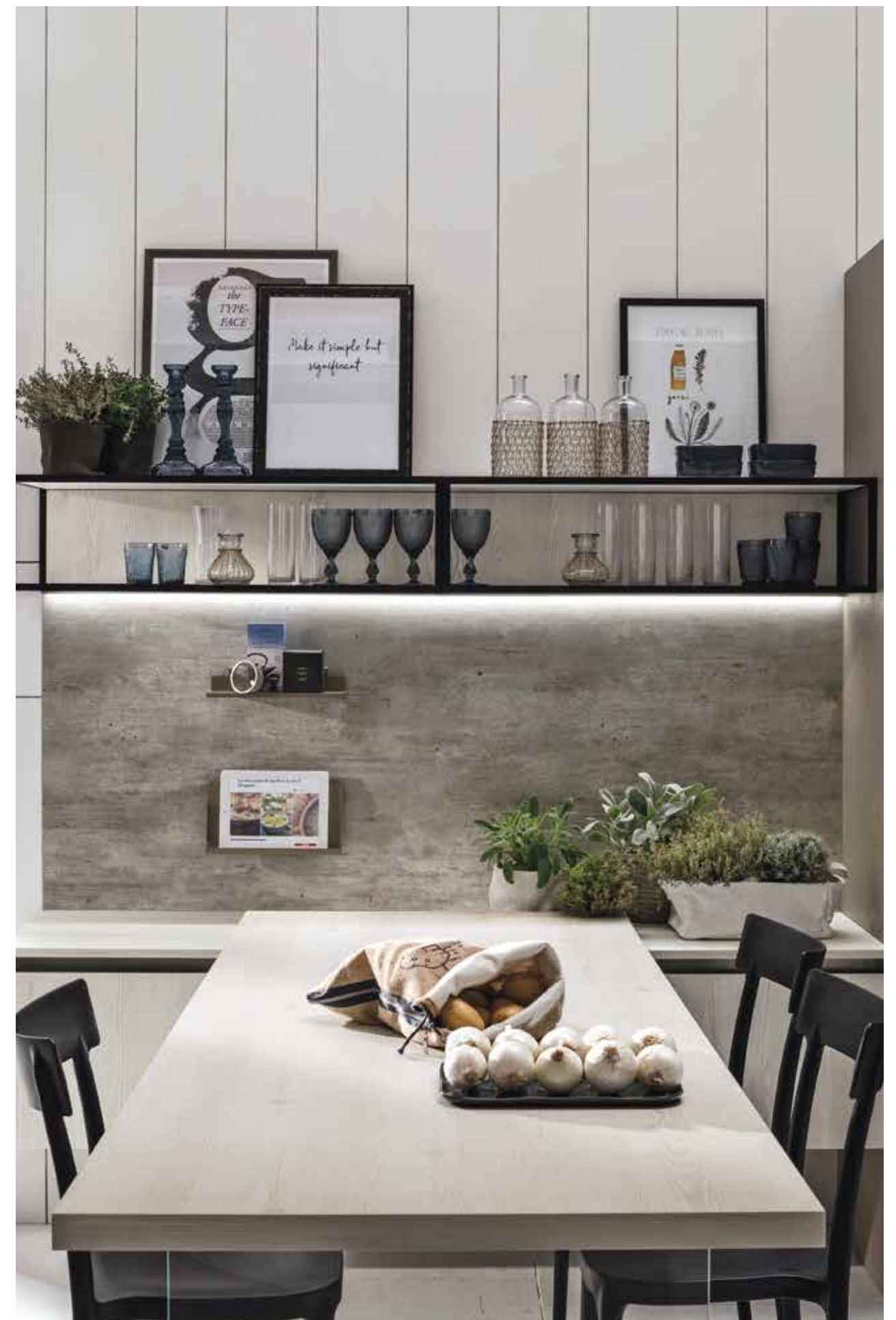

Magnetolab HPL Argilla con mensola e porta tablet in finitura titanio. - Magnetolab Argilla HPL, shelf and tablet holder with titanium finishing.



Magnetolab HPL Argilla con porta tablet e porta spezie + porta rotolo in finitura titanio. - Magnetolab Argilla HPL, tablet holder and spices and kitchen roll holder with titanium finishing.

GRES
GRES





Magnetolab gres illuminazione radente con mensola, porta mestoli e porta tablet in finitura inox.

Magnetolab grazing LED lighting gres, shelf, ladle holder and tablet holder with stainless steel finishing.



Magnetolab gres illuminazione radente con mensola, porta mestoli e porta tablet in finitura inox.

Magnetolab grazing LED lighting gres, shelf, ladle holder and tablet holder with stainless steel finishing.



Magnetolab gres Calacatta con oliera, porta mestoli e barra appendi e aggancia in finitura titanio e ceppo porta coltelli in legno.

Magnetolab gres Calacatta, oil and vinegar jars holder, ladle holder and ladle holder with hooks with titanium finishing and beechwood knife block.



Magnetolab Marble Calacatta Gold con due barre appendi e aggancia e porta tablet in finitura inox e ceppo porta coltelli in legno.

Magnetolab Marble Calacatta Gold with two inox finish ladle holders with hooks and tablet holder and beechwood knife block.



Magnetolab gres Pietra Piasentina grigia

Magnetolab gres Gray Pietra Piasentina



Magnetolab gres Kelya con ceppo porta coltelli in legno, porta tablet, mensola, porta spezie e rotolo, porta mestoli e porta rotoli in finitura bianco opaco.

Magnetolab gres Kelya with beechwood knife block and matt white tablet holder, shelf, spices and kitchen roll holder, ladle holder and kitchen rolls holder.

GRES



Magnetolab in gres Kelya con ceppo porta coltelli in legno e mensola in finitura bianco opaco. - Magnetolab gres Kelya with beechwood knife block and with matt white shelf.



DUETTO

Luce e materia si uniscono per un effetto sorprendente.

L'alzata in materia crea armonia in continuità con il piano della cucina e la parte superiore illumina l'area di lavoro e l'ambiente circostante. Grazie a questa soluzione è possibile comporre lo schienale utilizzando due tipi di materiali: vetro luminoso lucido o opaco in qualsiasi colore e HPL o gres nella finitura in abbinamento con il top.

Light and matter come together for a surprising effect.

The bottom zone in HPL or gres creates harmony in continuity with the kitchen top and the upper part illuminates the work area and the surrounding environment.

Thanks to this solution, it is possible to compose the backspalsh using two types of materials: glossy or opaque bright glass in any colour and HPL or gres in the finish in combination with the top.



Alzata Magnetolab gres Aura e parte superiore Magnetolab vetro lucido luminoso con porta capsule Nespresso, barra con ganci, mensola e porta mestoli in finitura inox.

Magnetolab gres Aura + Magnetolab lighting white glossy glass backsplash with "Nespresso" capsule holder beechwood finish and holder with hooks, shell and ladle holder with stainless steel finishing.

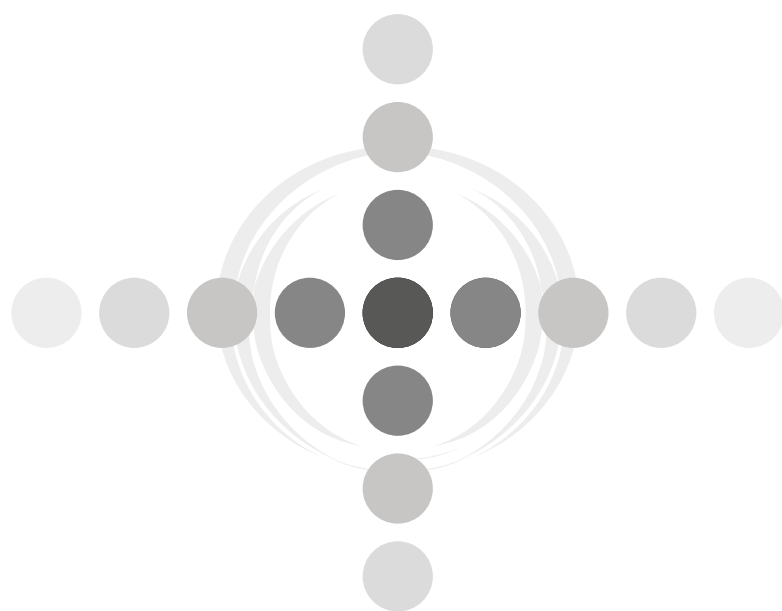

smart.
moving

Smart Moving è il sorprendente sistema di regolazione della luminosità del pannello Magnetolab che, grazie a sensori del movimento delle mani, gestisce l'accensione, lo spegnimento e l'intensità della luce, senza interruttori né telecomando.

Smart Moving permette di accendere, spegnere e regolare l'intensità della luce di Magnetolab effettuando semplici gesti con le mani intorno al piccolo LED luminoso posizionato nel pannello. Non è necessario toccare lo schienale, che resta così sempre pulito.

Smart Moving è disponibile esclusivamente nella versione pannello in vetro, sia lucido, sia acidato.

Smart Moving is the amazing hand operated dimmer system that regulates the brightness of Magnetolab backsplash panels. Thanks to its hand sensors, no switch nor remote control is required to turn on, turn off, and regulate light intensity.

Smart Moving allows turning on, turning off, and light intensity adjustment of the Magnetolab backsplash panels by simply moving your hand around the small LED embedded in the panel. Since the panel does not need to be touched, it remains clean at all times.

Smart Moving is available exclusively in the polished and frosted glass panel version.

ACCENSIONE / SPEGNIMENTO TURNING ON / TURNING OFF



DAL BASSO VERSO L'ALTO
Muovendo la mano dal basso verso l'alto Magnetolab si accende

FROM BOTTOM TO TOP
Move your hand from bottom to top to light Magnetolab up

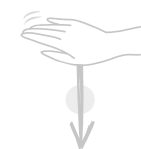

DALL'ALTO VERSO IL BASSO
Muovendo la mano dall'alto verso il basso Magnetolab si spegne

FROM TOP TO BOTTOM
Move your hand from top to bottom to turn Magnetolab off

AUMENTO / DIMINUIZIONE LUMINOSITÀ DIMMING / BRIGHTENING



DA SINISTRA A DESTRA
Muovendo la mano da sinistra a destra la luminosità del pannello aumenta ad ogni passaggio

FROM LEFT TO RIGHT
Pass your hand from left to right over the LED until you reach the desired brightness



DA DESTRA A SINISTRA
Muovendo la mano da destra a sinistra la luminosità del pannello diminuisce ad ogni passaggio.

FROM RIGHT TO LEFT
Pass your hand from right to left over the LED until you reach the desired dimness

AUMENTO GRADUALE / DIMINUIZIONE GRADUALE LUMINOSITÀ (DIMMER) GRADUAL BRIGHTENING / GRADUAL DIMMING (DIMMER) DIMMING / BRIGHTENING



ROTAZIONE CONTINUA VERSO DESTRA
Ruotando continuamente verso destra il dito intorno al LED la luminosità del pannello e del cursore led aumenta gradualmente (dimmer)

CLOCKWISE CONTINUOUS ROTATION
Rotating your finger clockwise around the LED causes both the panel and LED cursor brightness to increase (dimmer).



ROTAZIONE CONTINUA VERSO SINISTRA
Ruotando continuamente verso sinistra il dito intorno al LED la luminosità del pannello e del cursore led diminuisce gradualmente (dimmer).

ANTICLOCKWISE CONTINUOUS ROTATION
Rotating your finger anticlockwise around the LED causes both the panel and LED cursor brightness to decrease (dimmer).

HELPHY LIGHT

Black-out in casa?

Niente paura, HELPY LIGHT è il sistema di illuminazione di sicurezza di Magnetolab che, in caso di interruzione di energia elettrica, riattiva la luce dello schienale permettendoti di continuare i lavori in cucina, illuminando anche l'ambiente circostante.

L'autonomia di HELPY LIGHT varia da 1 a 4 ore a seconda dall'intensità di luce desiderata.

Black-out in the house?

Don't worry, Helpy Light is Magnetolab's safety lighting system which, in the event of a power failure, reactivates the light on the backsplash allowing you to continue working in the kitchen, also illuminating the surrounding environment.

HELPHY LIGHT autonomy of the lighting varies from 1 to 4 hours depending on the desired light intensity.





È-SSENZA

È-SSENZA: LA CAPPA INTEGRATA NELLO SCHIENALE MAGNETOLAB

È-SSENZA

Sviluppata in collaborazione con Falmec, è caratterizzata dalla completa integrazione con Magnetolab grazie al suo flap che viene realizzato nella medesima finitura dello schienale e che, una volta chiuso, restituisce allo stesso una superficie perfettamente lineare per una facile pulizia e la massima resa estetica.

ASPIRAZIONE POSTERIORE

I fumi di cottura sono aspirati dallo schienale in maniera uniforme rispetto alle zone di cottura.

EFFICACIA E SILENZIOSITÀ

Un motore potente ed efficiente, unito allo studio dei flussi d'aria e all'uso di materiali isolanti permette la miglior performance di aspirazione con il minimo apporto di rumore.

FACILE INSTALLAZIONE E MINIMO INGOMBRO

Il sistema aspirante, completamente integrato nello schienale Magnetolab, permette una facile installazione sia nella versione filtrante, che aspirante.

La cappa si sviluppa in verticale, nella parte posteriore, favorendo il massimo utilizzo degli spazi interni delle basi e dei pensili.



È-SSENZA

È-SSENZA: THE HOOD INTEGRATED IN THE MAGNETOLAB BACKSPLASH

È-SSENZA

Developed in collaboration with Falmec, it is characterized by complete integration with Magnetolab thanks to its flap which is made in the same finish as the backrest and which, once closed, gives it a perfectly linear surface for easy cleaning and maximum aesthetic performance.

REAR SUCTION

The cooking fumes are extracted via a linear and elegant flap door suction system, in a balanced way with respect to the cooking areas.

SILENT EFFECTIVENESS

A powerful and efficient engine - combined with a careful study of air flows and the use of insulating materials - allows for the highest suction performance and minimum noise.

EASY INSTALLATION AND SMALL OVERALL DIMENSIONS

The suction system completely embedded into the Magnetolab backsplash is easy to install, both in the filtering and suction versions. The hood develops vertically at the rear, favouring maximum use of the internal spaces of the base and wall units.

PARTNERSHIP

Grazie ad importanti partnership con aziende leader di settore, Magnetolab garantisce innovazione, qualità e resistenza dei materiali. Thanks to important partnerships with leading companies in the sector, Magnetolab guarantees innovation, quality and resistance of materials.

falmec Falmec ha saputo trasformarsi da piccola realtà artigianale a protagonista del mercato italiano ed internazionale, maturando una grande esperienza nella progettazione e produzione di cappe aspiranti. Ricerca all'avanguardia, flessibilità produttiva, sviluppo di nuove tecnologie e creatività originale, conferiscono alle collezioni Falmec un forte valore aggiunto di innovazione ed una combinazione del tutto unica di design ed eccellenza tecnica, collocandosi ai massimi livelli dell'eccellenza italiana nel mondo.

Falmec has evolved from a small manufacturing company to a leading force both in the national and international market, gaining extensive experience in the design and production of cooker hoods. Cutting-edge research, flexibility in production, development of new technologies and original creativity endow the Falmec collections with a strong added value in terms of innovation, and a totally unique blend of design and cutting edge technology, reaching the highest levels of Italian excellence in the world.

nh – newform Estetica e funzionalità, design e originalità, insieme alla cura per i dettagli, rappresentano gli elementi distintivi della qualità e della ricerca Newform. Nata in Piemonte più di 30 anni fa, è cresciuta negli anni fino a diventare una delle grandi protagoniste del settore dell'arredamento cucina e bagno. Fin da subito, i prodotti nascono dalla capacità di rappresentare la cultura contemporanea e rispondere tempestivamente all'evoluzione dell'abitare.

Aesthetics and functionality, design and originality, together with attention to detail, represent the distinguishing features of Newform quality and research.

Born in Piemonte (Italy) more than 30 years ago, Newform has grown over the years to become one of the major protagonists in the kitchen and bathroom furnishing sector. From the very outset, the products arise from the ability to represent contemporary culture and to react promptly to the evolution of living.

DEKTON Dekton è un mix di materie prime molto sofisticate usate in edilizia, materiali porcellanati di ultima generazione, vetro e superfici in quarzo che legandosi tra loro cambiano e compattano la propria struttura interna dando vita ad una superficie sottile e ultracompatta. Le principali caratteristiche sono: ridotto assorbimento di acqua, stabilità cromatica, resistenza a graffi, urti, alla compressione e alla flessione, elevata resistenza ai raggi ultravioletti, massima resistenza a fuoco e calore, resistenza alle macchie.

Dekton is a mix of highly sophisticated raw materials used in the construction business. The latest porcelain materials, glass and quartz bind together by changing and tightening their internal structure, thus creating a thin and ultra-compact surface. The outcome is a stain-proof surface with reduced water absorption, chromatic stability, as well as being resistant to scratches, shocks, compression and bending and highly resistant to ultraviolet rays, fire, and heat.

FLORIM stone Flessibilità, creatività ed elevate performance tecniche ed estetiche sono le caratteristiche della produzione Florim che coniuga qualità dei materiali, cura dei particolari e facilità di trasformazione, garantiti da oltre cinquant'anni di esperienza e ricerca tecnologica ed estetica.

Over 50 years of experience in technological research, flexibility, and creativity guarantee the high performance of Florim. Their production combines beauty with quality of materials and an eye for detail.

LAMINAM Specialista nella produzione di lastre ceramiche di grande formato e minimo spessore, Laminam è la prima azienda al mondo ad averne industrializzato il processo produttivo, introducendo nel mercato nuove applicazioni d'uso del gres porcellanato, spaziando dall'architettura d'esterni ed interni, all'arredamento. Laminam si contraddistingue per il processo produttivo tecnologicamente avanzato e un approccio eco-compatibile che affonda le basi su tre pilastri: materie prime naturali, tecnologie sostenibili e prodotti riciclabili.

Laminam specialise in the production of ceramic slabs of large size and minimum thickness. They were the first to industrialise the production process of porcelain stoneware, education the market to adopt porcelain stoneware in new sectors, ranging from interior and exterior architecture to furnishings.

Laminam stands out thanks to its technologically advanced production process and eco-compatible approach. Natural raw materials, sustainable technology and recyclable products are the pillars of their philosophy.

NEOLITH® TheSize Surfaces fu fondata nel 2009 ed è un'azienda giovane che si avvale dell'esperienza di più di 40 anni dei suoi dirigenti nel settore della pietra naturale. Nel 2010 lanciò sul mercato la sua prima lastra sotto il marchio Neolith®, con il proposito di dare una risposta innovativa al settore dell'architettura e del design di interni. Un nuovo materiale dalle straordinarie caratteristiche, idoneo sia per interni che per esterni.

TheSize Surfaces was founded in 2009. Despite the company being young, it draws on the experience of its executive officers who have been operating in the natural stone sector for over 40 years. Under the brand Neolith® it launched its first slab production in 2010, with the aim of providing an innovative response to the architecture and interior design sectors. The extraordinary features of this new material make it suitable for both indoors and outdoors use.

MATERIALI E FINITURE MATERIALS AND FINISHES

Colori di serie per pannello in vetro lucido e opaco

Standard colours for Panel in glossy or matt glass

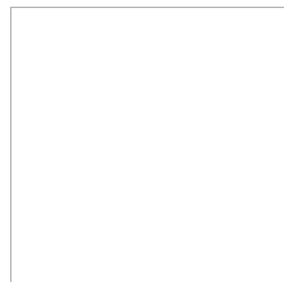

31
Bianco assoluto lucido
Glossy white



31-A
Bianco opaco
Matt white

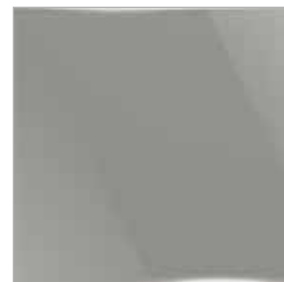

51
Terra

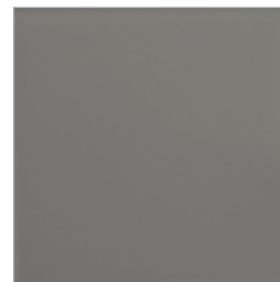

51-A
Terra opaco



52
Sabbia



52-A
Sabbia opaco



53
Creta



53-A
Creta opaco



35
Nero lavagna*
Non disponibile nella
versione con luce LED Integrata
Not available in the built-in
LED lighting version



36
RAL CLASSIC
Disponibile in tutti i colori
della collezione RAL Classic
Available in all the colours
of the Ral Classic collection

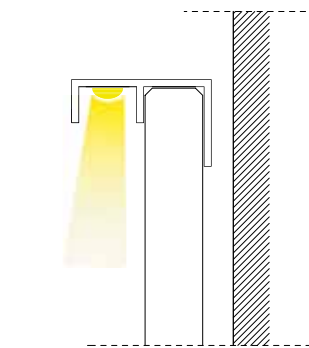

ILLUMINAZIONE LED RADENTE
GRAZING LED LIGHTING

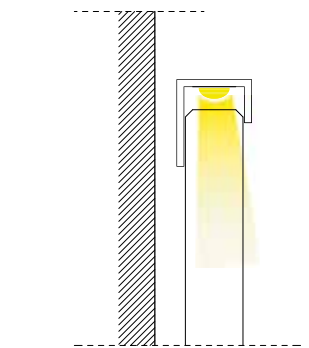

ILLUMINAZIONE LED INTEGRATA
BUILT-IN LED LIGHTING

Il pannello in vetro lucido o opaco, nei colori di serie e Ral, è disponibile nella versione con illuminazione LED integrata (escluso il colore 35 Nero Lavagna), ma si sconsiglia l'uso di colori scuri che possono ridurre notevolmente l'effetto luminoso.

Il Pannello in vetro lucido o opaco, nei colori di serie e RAL, è disponibile nella versione con illuminazione LED Radente, senza limitazioni. Il Pannello in materia, in qualsiasi finitura HPL o gres, è disponibile esclusivamente nella versione con illuminazione LED Radente.

The panel in glossy or frosted glass, in the standard and RAL colours, is available in the version with built-in LED lighting (except for the 35 Nero Lavagna colour), but the use of dark colours is not recommended as they can considerably reduce the lighting effect.

The panel in polished or frosted glass, in the standard and RAL colours, is available in all colours without limitation in the grazing LED lighting version.

The panel in material, in any finish HPL or gres, is available exclusively in the grazing LED lighting version.

Materiali e finiture per pannelli diversi dal vetro

Materials and finishes for panels other than glass

Magnetolab può essere realizzato in VETRO (vedi pagina precedente), **GRES** o **HPL**.

Per ogni tipologia di materiale è possibile scegliere tra una larga gamma di finiture per far fronte a qualsiasi esigenza di stile e installazione.

Magnetolab can be made in GLASS (see previous page), **GRES** or **HPL**.

For each type of material it is possible to choose from a wide range of finishes to meet any style and installation need.

Essendo un sistema in continuo aggiornamento, si consiglia di consultare la sezione **Materiali e Finiture** del sito Magnetolab - www.magnetolab.it/materiali-finiture

Magnetolab is a constantly updated system, so it is advisable to consult the **Materials and Finishes** section of the Magnetolab website - www.magnetolab.it/materiali-finiture



Colori profili alluminio per pannello

Aluminium profiles colours for panel



41
Alluminio Brill - Aluminium



42
Bianco Opaco - Matt white 9003



45
Titanio - Titanium

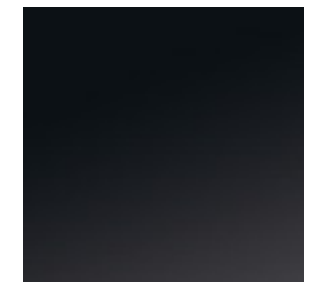

47
Nero Piombo - Lead black

Finiture accessori

Accessories Finishes



41
Inox Scotch-Brite - Stainless steel



42
Bianco Opaco - Matt white 9003



45
Titanio - Titanium

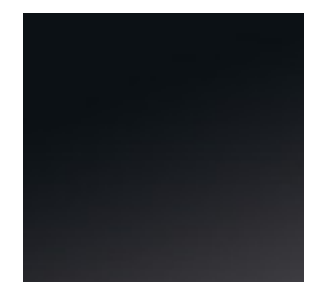

47
Nero Piombo - Lead black

Pannello Magnetico Vetro
Magnetic Glass Panel

Esploso Tecnico
Exploded technical scheme

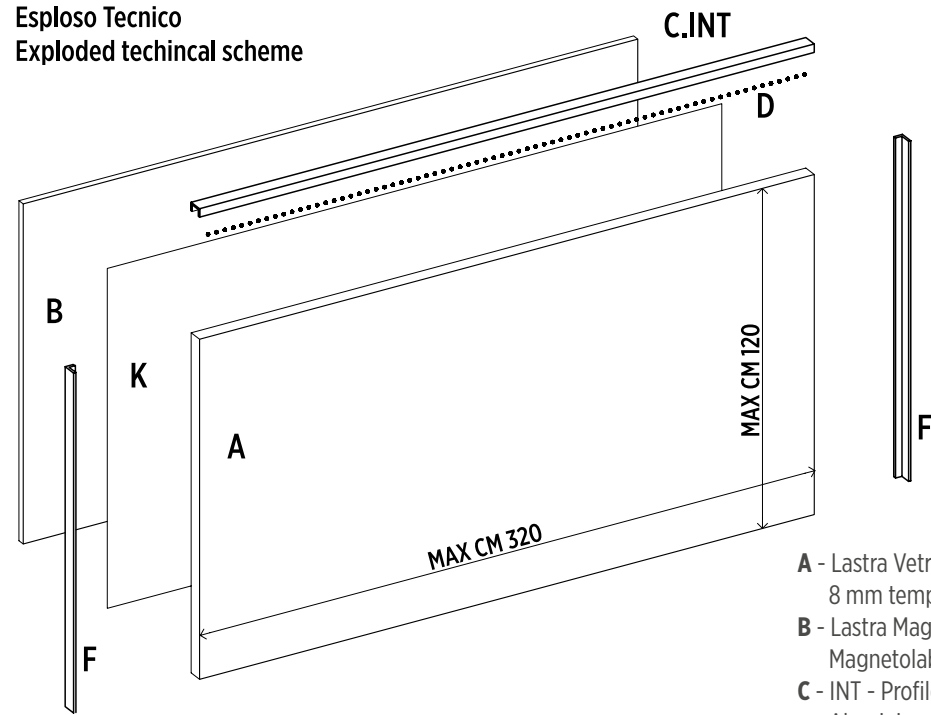

- A** - Lastra Vetro Temperato 8 mm
8 mm tempered glass plate
- B** - Lastra Magnetolab
Magnetolab Plate
- C** - INT - Profilo Alu con Illuminazione LED Integrata
Aluminium profile with integrated LED lighting
- D** - Strip LED HL
- F** - Profilo alluminio protezione laterale
Aluminium Profile side protection
- H** - Supporto Magnetico per fissaggio a parete
Wall attachment magnet
- K** - Trattamenti Chimici e Meccanici
Chemical and mechanical treatments

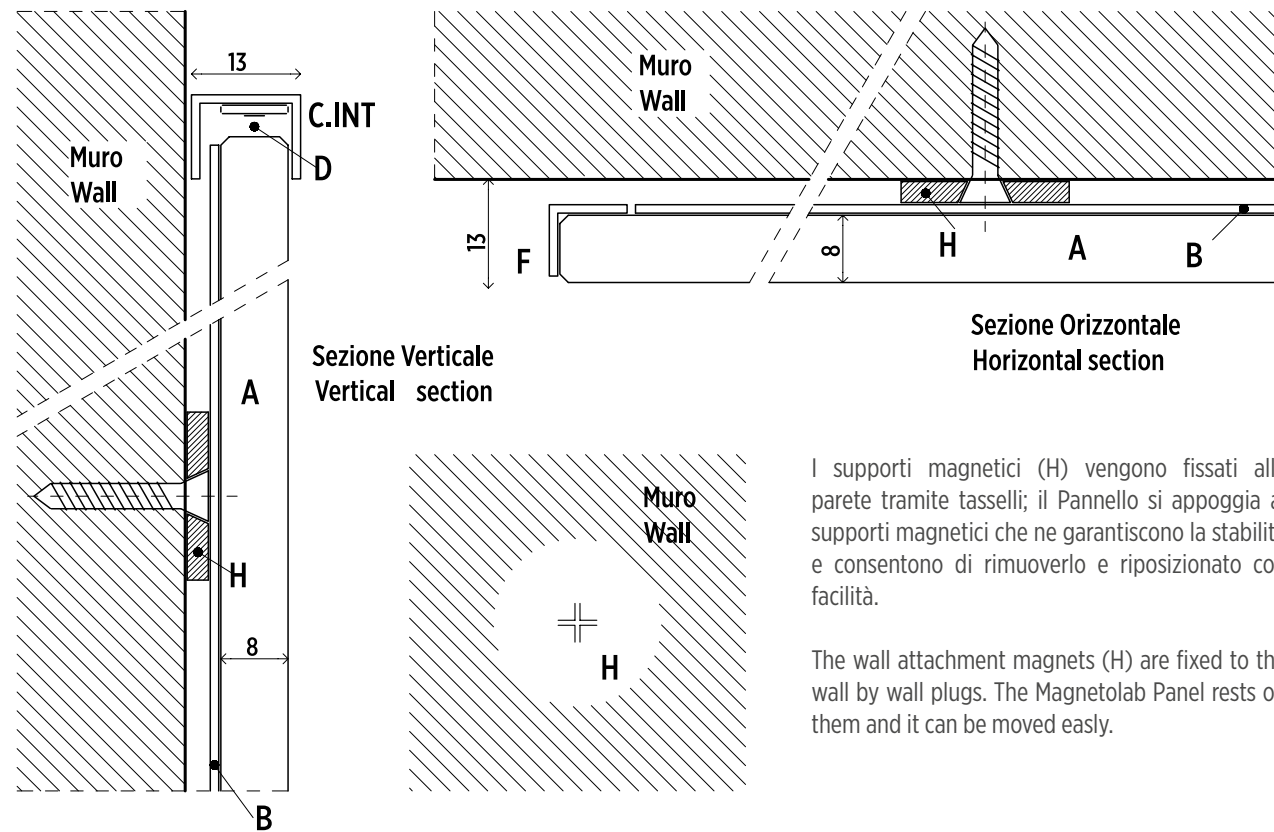

I supporti magnetici (H) vengono fissati alla parete tramite tasselli; il Pannello si appoggia ai supporti magnetici che ne garantiscono la stabilità e consentono di rimuoverlo e riposizionarlo con facilità.

The wall attachment magnets (H) are fixed to the wall by wall plugs. The Magnetolab Panel rests on them and it can be moved easily.

Per risolvere irregolarità di muri o compensare angoli in fuori squadra, è possibile distanziare il magnete H dal muro attraverso l'inserimento di una o più rondelle in ABS (L)
To resolve irregularities in walls or compensate for out-of-square angles, it is possible to distance the magnet H from the wall by inserting one or more ABS washers (L)

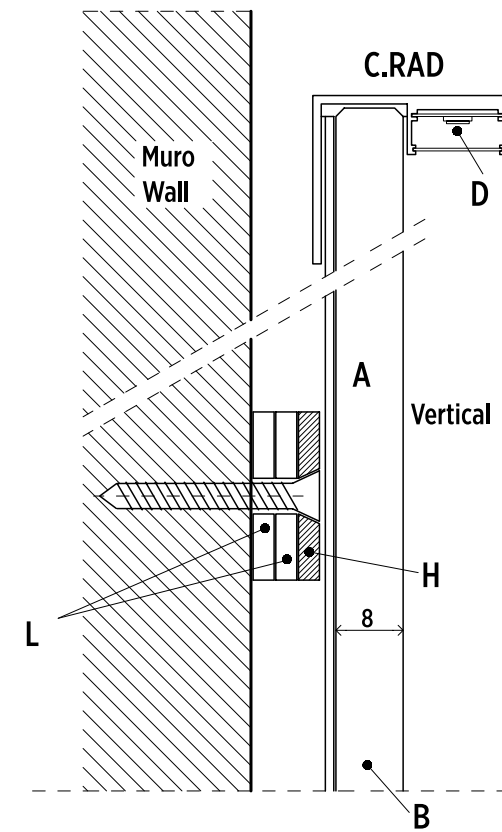

- A** - Lastra in materia 8 mm
8 mm plate
- B** - Lastra Magnetolab
Magnetolab Plate
- C** - RAD - Profilo Alu con Illuminazione LED Radente
Aluminium profile with wall LED lighting
- D** - Strip LED HL
- F** - Profilo alluminio protezione
Aluminium Profile protection
- H** - Supporto Magnetico per fissaggio a parete
Wall attachment magnet
- K** - Trattamenti Chimici e Meccanici
Chemical and mechanical treatments
- L** - Rondelle in ABS
ABS washers

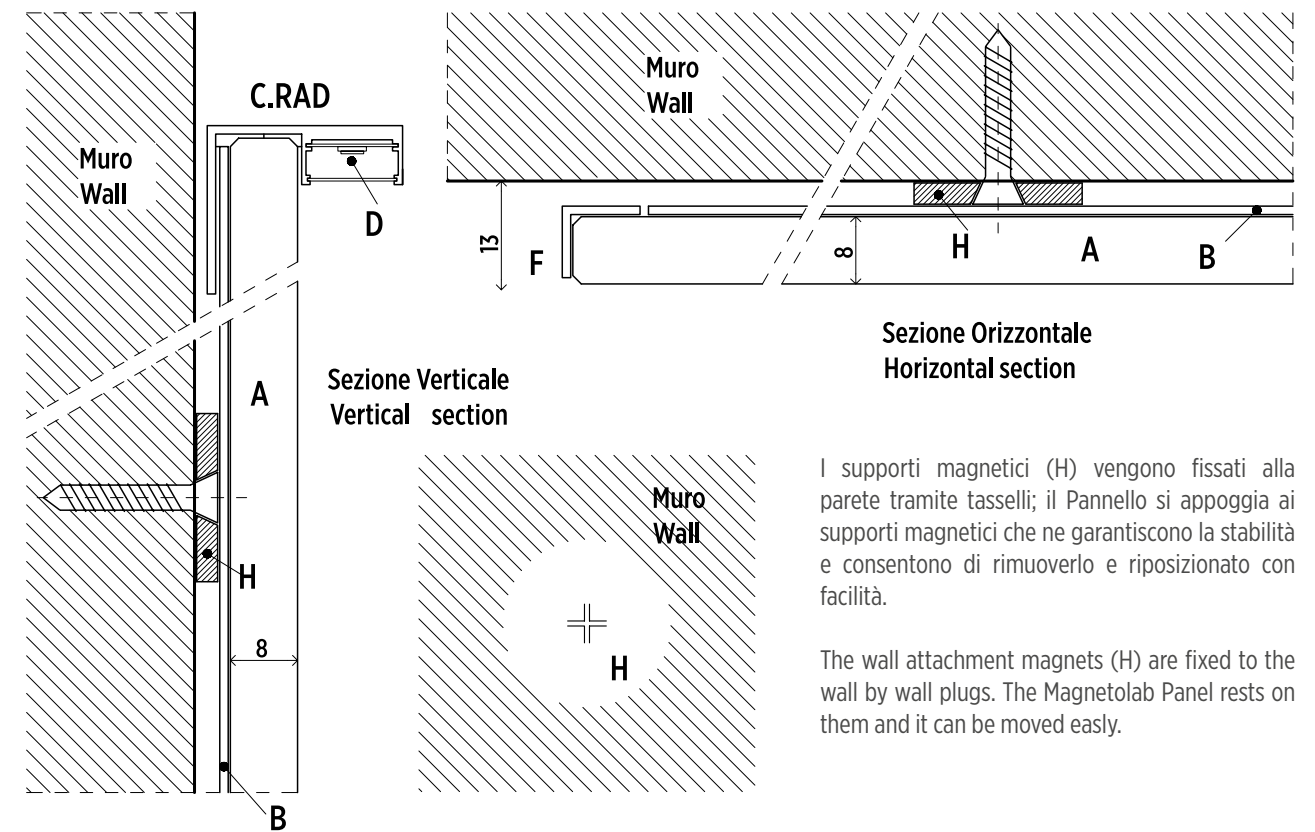

I supporti magnetici (H) vengono fissati alla parete tramite tasselli; il Pannello si appoggia ai supporti magnetici che ne garantiscono la stabilità e consentono di rimuoverlo e riposizionarlo con facilità.

The wall attachment magnets (H) are fixed to the wall by wall plugs. The Magnetolab Panel rests on them and it can be moved easily.



ACCESSORI
ACCESSORIES











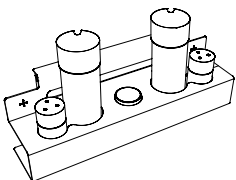

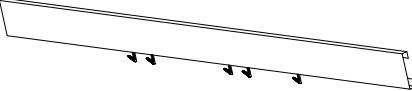

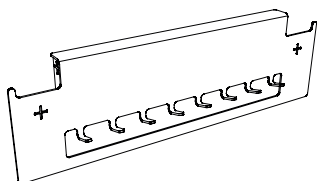
Magnetolab gres Kelya con ceppo porta coltelli in legno, porta tablet, mensola, porta spezie e rotolo in finitura bianco opaco.

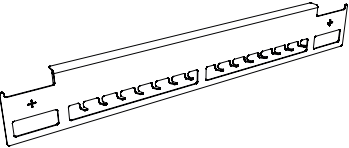

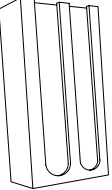

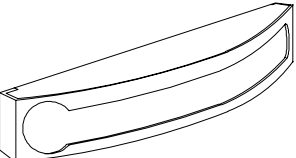



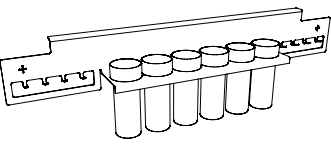

Magnetolab gres Kelya with beechwood knife block, matt white tablet holder, knife holder, shelf and spices and kitchen roll holder.

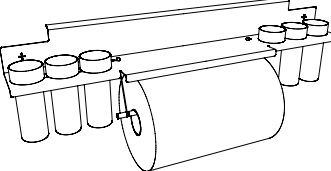

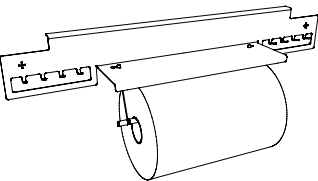
		DESCRIZIONE	FINITURA/COD*
Mensola / Shell			
		A: 300, B: 108, H: 64 mm Portata massima / Maximum load: 2000 g Imballo / Packaging: 2000 g - A: 320, B: 160, H: 120 mm	I: A01 - 41 W: A01 - 42 T: A01 - 45 B: A01 - 47
Porta mestoli / Ladle holder			
		A: 300, B: 96, H: 149 mm Portata massima / Maximum load: 2300 g Imballo / Packaging: 1050 g - A: 320, B: 160, H: 120 mm	I: A02 - 41 W: A02 - 42 T: A02 - 45 B: A02 - 47
Porta spezie / Spices holder			
		A: 313, B: 81, H: 150 mm Portata massima / Maximum load: 1800 g Imballo / Packaging: 1050 g - A: 320, B: 210, H: 130 mm	I: A03 - 41 W: A03 - 42 T: A03 - 45 B: A03 - 47
Porta tablet / Tablet holder			
		A: 300, B: 64, H: 143 mm Portata massima / Maximum load: 2500 g Imballo / Packaging: 1200 g - A: 320, B: 160, H: 120 mm	I: A04 - 41 W: A04 - 42 T: A04 - 45 B: A04 - 47
Porta rotolo / Kitchen paper roll holder			
		A: 285, B: 104, H: 55 mm Portata massima / Maximum load: 2000 g Imballo / Packaging: 1100 g - A: 320, B: 160, H: 120 mm	I: A05 - 41 W: A05 - 42 T: A05 - 45 B: A05 - 47
Porta rotoli / Kitchen rolls holder			
		A: 285, B: 149, H: 129 mm Portata massima / Maximum load: 2000 g Imballo / Packaging: 1270 g - A: 320, B: 210, H: 130 mm	I: A06 - 41 W: A06 - 42 T: A06 - 45 B: A06 - 47
Porta bottiglia / Bottle holder			
		A: 300, B: 97, H: 86 mm Portata massima / Maximum load: 2000 g Imballo / Packaging: 1080 g - A: 320, B: 160, H: 120 mm	I: A07 - 41 W: A07 - 42 T: A07 - 45 B: A07 - 47

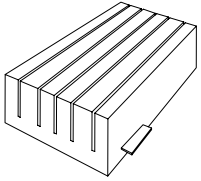
		DESCRIZIONE	FINITURA/COD*
Oliera / Oil and vinegar jars holder			
		A: 313, B: 85, H: 103 mm Portata massima / Maximum load: 2000 g Imballo / Packaging: 1230 g - A: 320, B: 160, H: 120 mm	I: A08 - 41 W: A08 - 42 T: A08 - 45 B: A08 - 47
Barra con ganci / Holder with hooks			
		A: 600, B: 40, H: 74 mm Portata massima / Maximum load: 3000 g Imballo / Packaging: 1662 g - A: 720, B: 80, H: 110 mm	I: A09-600 - 41 W: A09-600 - 42 T: A09-600 - 45 B: A09-600 - 47
		A: 900, B: 40, H: 74 mm Portata massima / Maximum load: 3000 g Imballo / Packaging: 1735 g - A: 1020, B: 80, H: 110 mm	I: A09-900 - 41 W: A09-900 - 42 T: A09-900 - 45 B: A09-900 - 47
		A: 1200, B: 40, H: 74 mm Portata massima / Maximum load: 3000 g Imballo / Packaging: 2594 g - A: 1320, B: 80, H: 110 mm	I: A09-1200 - 41 W: A09-1200 - 42 T: A09-1200 - 45 B: A09-1200 - 47
Barra appendi e aggancia / Ladle holder with hooks			
		A: 300, B: 32, H: 88 mm Portata massima / Maximum load: 3000 g Imballo / Packaging: 770 g - A: 320, B: 160, H: 120 mm	I: A10-300 - 41 W: A10-300 - 42 T: A10-300 - 45 B: A10-300 - 47
		A: 600, B: 32, H: 88 mm Portata massima / Maximum load: 6000 g Imballo / Packaging: 1530 g - A: 670, B: 110, H: 120 mm	I: A10-600 - 41 W: A10-600 - 42 T: A10-600 - 45 B: A10-600 - 47
Porta capsule "Nespresso" in essenza faggio / "Nespresso" capsule holder, beechwood finish			
		A: 102, B: 30, H: 240 mm Imballo / Packaging: 580 g - A: 150, B: 50, H: 280 mm	A12
Porta capsule "Nespresso" in faggio e acciaio / "Nespresso" capsule holder, beechwood and steel finish			
		A: 360, B: 30, H: 45 mm Imballo / Packaging: 413 g - A: 380, B: 225, H: 130 mm	I: MA14AC - 41 W: MA14AC - 42 T: MA14AC - 45 B: MA14AC - 47

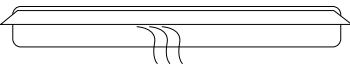
I: Inox Scotch-Brite - Stainless steel ; W: Bianco Opaco - Matt White ; T: Titanio - Titanium; B: Nero piombo - Lead black

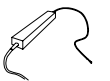
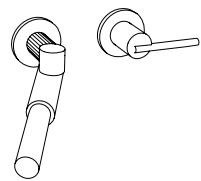
		DESCRIZIONE	FINITURA/COD*
Porta spezie + barra appendi e aggancia / Pices and ladle holder			
		A: 600, B: 82, H: 154 mm Portata massima / Maximum load: 4000 g Imballo / Packaging: 1700 g - A: 670, B: 110, H: 120 mm	I: A21 - 41 W: A21 - 42 T: A21 - 45 B: A21 - 47
Porta spezie + porta rotolo / Spices and kitchen roll holder			
		A: 600, B: 102, H: 154 mm Portata massima / Maximum load: 3500 g Imballo / Packaging: 1720 g - A: 70, B: 110, H: 120 mm	I: A22 - 41 W: A22 - 42 T: A22 - 45 B: A22 - 47
Porta rotolo + barra appendi e aggancia / Kitchen roll and ladle holder			
		A: 600, B: 102, H: 124 mm Portata massima / Maximum load: 4000 g Imballo / Packaging: 1630 g - A: 670, B: 110, H: 120 mm	I: A23 - 41 W: A23 - 42 T: A23 - 45 B: A23 - 47
Ceppo porta coltelli in legno essenza faggio / Beechwood knife block			
		A: 120, B: 230, H: 60 mm Portata massima / Maximum load: 2000 g Imballo / Packaging: 980 g - A: 290, B: 180, H: 100 mm	MA12AC
È-SSENZA Cappa integrata / Integrated hook			
		A: 880, H: 100 mm Imballo / Packaging: 32000 g - A: 1300, B: 600, H: 400 mm	MAK01 - ___
Accensione Smart Moving / Turn off Smart Moving			
			MA03EL
HELPY LIGHT			
		A: 200, B: 100, H: 40 mm Imballo / Packaging: 300 g - A: 250, B: 120, H: 50 mm	MA04EL
Miscelatore integrato Moony - Integrated Moony Mixer			
		Imballo / Packaging: 3000 g - A: 300, B: 150, H: 120 mm	MAM001

I: Inox Scotch-Brite - Stainless steel ; W: Bianco Opaco - Matt White ; T: Titanio - Titanium; B: Nero piombo - Lead black

magnetolab
CREA IL TUO SPAZIO

Magnetolab Is a trademark of LABOC Srl
Via dell'Industria 1 - 06031 Bevagna - Perugia - ITALY
Tel. +39.0742.360278
info@magnetolab.it- www.magnetolab.it

grafica e impaginazione: ubiquo.it

magne+olab

CREA IL TUO SPAZIO