

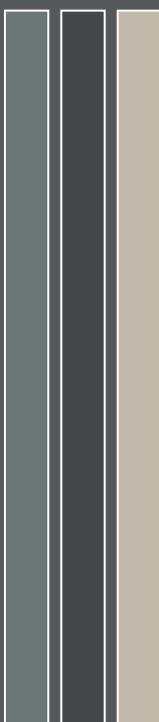

italian origin



C A T A L O G O

L I S T I N O

2 0 2 1

2 0 2 2

LE EMOZIONI
TROVANO CASA



BENVENUTI NEL MONDO
ELLECI

Azienda.....	4
I nostri Valori	5
Scegliere Elleci	6
Materiali	8
Siamo Green	14
Preparing Area	16
Highlights 2021/22	18
Elleci for You	28
Indice completo prodotti	30
Lavelli	
Globe	36
Dogma	44
Value	50
Karisma	56
Integra	62
Zen	68
Best Workstation	74
Best	80
Quadra	88
Quadra Sottotop	98
Unico	108
Ego	116
Tekno	124
Easy	132
Fox	142
Master	150
Living	158
Accessori.....	166
Lavelli Inox	180
Miscelatori.....	186
Elettrodomestici	224
Forni e Forno a Microonde	232
Piani Cottura.....	242
Cappe.....	260
Dissipatori	262
Assistenza tecnica	266
Tabella comparativa	268

LA NOSTRA AZIENDA

Da **30 anni**
sempre un
passo avanti.

ANTICIPARE IL FUTURO È ALLA BASE DEL **NOSTRO SUCCESSO**

Viviamo l'oggi proiettati al domani; proattività, visione di insieme e lungimiranza disegnano per noi il futuro come possibile. Innovazione tecnologica, cultura dei materiali, expertise e design ci permettono di realizzare prodotti e servizi capaci di elevare la user experience dei nostri clienti in tutto il mondo ed essere riconosciuti come Brand. Una filosofia che ci distingue, che rende unico il nostro viaggio verso obiettivi ambiziosi: contribuire a migliorare il domani attraverso soluzioni sempre nuove dove la funzionalità incontra il design e l'ergonomia ridisegna gli spazi anticipandone i bisogni.



2021- UN ANNO RICCO DI **RICONOSCIMENTI**

Numerosi sono stati i riconoscimenti per la nostra azienda nel corso del 2021: Per il modo di "fare Impresa" spicca tra tutti, l'essere stati identificati come una "Storia di Eccellenza", ambasciatori della bellezza del Made In Italy nel mondo all'interno della Manifestazione 100 Eccellenze Italiane, svoltosi in Campidoglio a Roma. Per il Design dei Prodotti, ci è stata riconosciuta la capacità di "trasformare il lavello in oggetto di design" che si è tradotta in un palmares di premi importanti, tra i quali il prestigioso Red Dot Design attribuito ad uno dei nostri nuovi concetti di Workstation. Tutto questo, per noi di Elleci, è una spinta a migliorare sempre: *il 2022 sarà certamente un anno che ci vedrà ancora protagonisti.*



I NOSTRI VALORI

CIÒ IN CUI CREDIAMO
RACCONTA CHI SIAMO

Il successo di Elleci è frutto dell'impegno e della dedizione del nostro team di lavoro, perché solo da indiscusse qualità nascono e si realizzano le idee più innovative.

Valori che ci accompagnano sin dal primo giorno, con i quali vogliamo approcciare il futuro.



ESPERIENZA

Tutta una questione di chimica e un sistema di produzione che fa la differenza.



PASSIONE

Donne e uomini capaci e appassionati che ogni giorno danno il loro meglio per i nostri clienti.



DESIGN E TECNOLOGIA

La creatività applicata all'eccellenza manifatturiera e all'innovazione dei materiali.

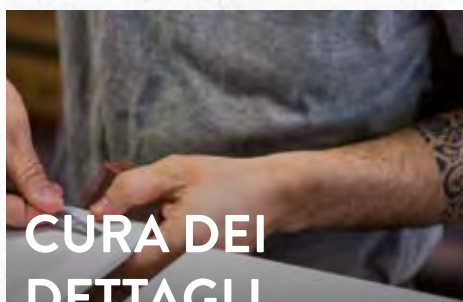

CURA DEI DETTAGLI

Ogni processo di ideazione e realizzazione dei nostri prodotti viene svolto con una straordinaria attenzione ai dettagli.

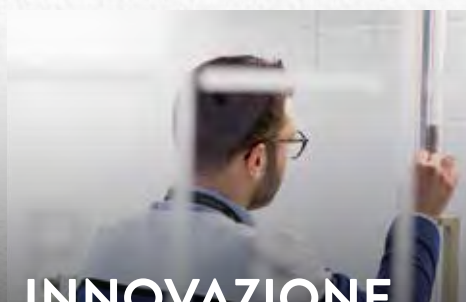

INNOVAZIONE

Innovare per noi significa guardare al futuro per lasciare un'impronta alle generazioni che verranno.



CREAZIONI 100% ITALIANE

Soluzioni tecniche all'avanguardia capaci di stupire e migliorare l'esperienza in cucina.

Ci sono ragioni che premiano
lavoro, ricerca e innovazione.
Che toccano il cuore e aprono al futuro.

**SCEGLIERE
ELLECI
HA I SUOI PERCHÉ**

CELEBRIAMO LA
MATERIA
ATTRAVERSO
I COLORI



SIAMO
GREEN DA SEMPRE

ENTRIAMO INSIEME IN UNA NUOVA DIMENSIONE
PREPARING AREA

L'ARTE INNATA DI PLASMARE I

MATERIALI

Dall'acqua alla materia.
Dalla materia al design.

NUOVE FORMULAZIONI, MASSIMA EFFICIENZA

L'abilità di innovare è racchiusa all'interno di ogni materiale:

- il Keratek Plus, con la sua superficie ultra compatta, formata da nanoparticelle di ceramica e un mix di 6 resine acriliche innovative, è una testimonianza d'eccellenza tangibile e duratura.
- il Granitek, che assume un aspetto ultra materico, è portavoce di creazioni sempre più avanzate e sorprendenti.

E poi ci sono i colori, mai così belli, che svelano un ambiente in cui tutto finalmente ha un senso, grazie a lavelli, elettrodomestici e accessori perfettamente coordinati.

TUTTA UNA QUESTIONE DI CHIMICA E G.P.S.

Una continua ricerca formale, funzionale ed emozionale, che mira a creare nuovi riferimenti di eccellenza tecnica, senza mai perdere di vista la dimensione umana del progetto.

La nostra esperienza nel proporre i migliori materiali ci ha permesso di fare la differenza e di distinguerci, grazie al nostro laboratorio, esempio di innovazione, e all'avanzata tecnologia del sistema di stampaggio G.P.S.

VANTAGGI KERATEK PLUS E GRANITEK



RESISTENTE AGLI
SHOCK TERMICI



RESISTENTE
ALL'URTO



FATTO PER
DURARE



PROTEZIONE IGIENICA,
CERTIFICATA PER IL
CONTATTO CON
GLI ALIMENTI



CERTIFICATO
GREENGUARD

KERATEK[®] Plus
CERAMIC NANOTECHNOLOGY CN6



SUPERFICIE
ULTRACOMPATTA

100%
IDROREPELENTE



ELEVATA SCORREVOLEZZA,
«EASY TO CLEAN»



GRANITEK[®]
NATURAL GRANITE EFFECT

SUPERFICIE
ULTRAMATERICA



K99 Dark Grey

K97 Light Grey

K96 White

K95 Champagne

K93 Dove Grey

K86 Black

GRANITEK®
NATURAL GRANITE EFFECT

Anche Granitek è stato sottoposto a un miglioramento della sua formulazione, conferendo alla superficie ancora più matericità tattile e visiva, esaltando le migliori qualità tecniche del granito: elevata resistenza alle alte temperature, agli urti e ai più violenti shock, oltre a un'estrema facilità di pulizia.

I colori Granitek sono stati suddivisi in:

METAL

dove alla miscela sono aggiunte particelle metalliche che conferiscono alla superficie una particolare e caratteristica finitura, lucente e brillante.

MATT

caratterizzato dal sofisticato e inconfondibile effetto opaco che rende i colori di questa linea adatti ad essere inseriti in ambienti cucina raffinati e moderni.

CLASSIC

dove le textures cromatiche fanno risaltare le particelle di granito, rendendo le superfici simili all'effetto della pietra naturale.



M79 Aluminium

M78 Espresso

M73 Titanium

M70 Ghisa

METAL

G68 Bianco

G48 Cemento

G43 Tortora

G40 Nero

MATT

G62 Bianco Antico

G59 Antracite

G55 Grigio Pietra

G54 Nero Pietra

G52 Bianco Pietra

G51 Avena

CLASSIC

SIAMO

GREEN

DA SEMPRE



CERTIFICATO GREENGUARD

Elleci ha da sempre intrapreso un percorso GREEN per rendere migliore l'unico mondo che abbiamo a disposizione e siamo orgogliosi di essere la prima azienda produttrice di lavelli in composito ad aver ottenuto la Certificazione GREENGUARD di UL (Underwriters Laboratories), una delle organizzazioni più riconosciute al mondo in materia di sicurezza, nata negli Stati Uniti oltre 125 anni fa.

Il Programma di Certificazione GREENGUARD certifica che tutti i lavelli in composito Elleci sono conformi agli standard più rigorosi in termini di livelli di emissione di composti organici volatili (COV) e di altre sostanze chimiche nocive negli ambienti interni, che possono avere effetti negativi sulla salute come mal di testa, bruciore agli occhi, irritazioni respiratorie e attacchi d'asma.



Possedere la Certificazione GREENGUARD significa garantire ai propri consumatori lavelli pensati e realizzati per contribuire a migliorare la qualità dell'aria interna alla propria casa rendendola più pulita e più sana. Significa offrire prodotti che rispondono a standard elevati di qualità, rigorosamente testati e certificati da un organismo di parte terza indipendente per basse emissioni di sostanze chimiche e composti organici volatili (COV).

Attraverso la Certificazione GREENGUARD, Elleci ha dimostrato in modo trasparente e serio il proprio impegno nel contribuire a creare ambienti cucina di qualità più sani e confortevoli. Si tratta di un impegno molto importante che Elleci assume nei confronti della propria clientela, perché al centro della mission aziendale c'è sempre la soddisfazione e la salute dei propri dipendenti e dei consumatori.

CICLO PRODUTTIVO A RIDOTTO IMPATTO AMBIENTALE

Il nostro approccio al recupero di materia ed energia dei rifiuti industriali, rappresenta un'alternativa ottimale che consente di risparmiare risorse naturali non rinnovabili e rigenerare materiali in condizioni di sicurezza per l'ambiente e per le persone.

Siamo costantemente impegnati nella progettazione di soluzioni innovative volte a ottimizzare al meglio le risorse naturali, evitando sprechi di acqua, energia e rifiuti organici in cucina.



PREPARING AREA

TANTE CATEGORIE DI PRODOTTO, MASSIMA ERGONOMIA.
L'ESTETICA SI INTEGRA CON LA FUNZIONALITÀ.

Ad un ambiente che si trasforma offriamo sempre nuove soluzioni: l'area preparing rappresenta il salto di qualità dell'ergonomia in cucina, la base su cui costruire un'esperienza mai vissuta prima.

Il coordinamento cromatico tra le molteplici categorie di prodotto esalta ogni spazio, grazie ad una serie di elementi in sintonia tra loro per estetica e funzionalità.

Coesistere e interagire significa, per noi, aggiungere valore a tutto ciò che si fa. A quello in cui si crede.

ENTRIAMO INSIEME IN UNA NUOVA DIMENSIONE

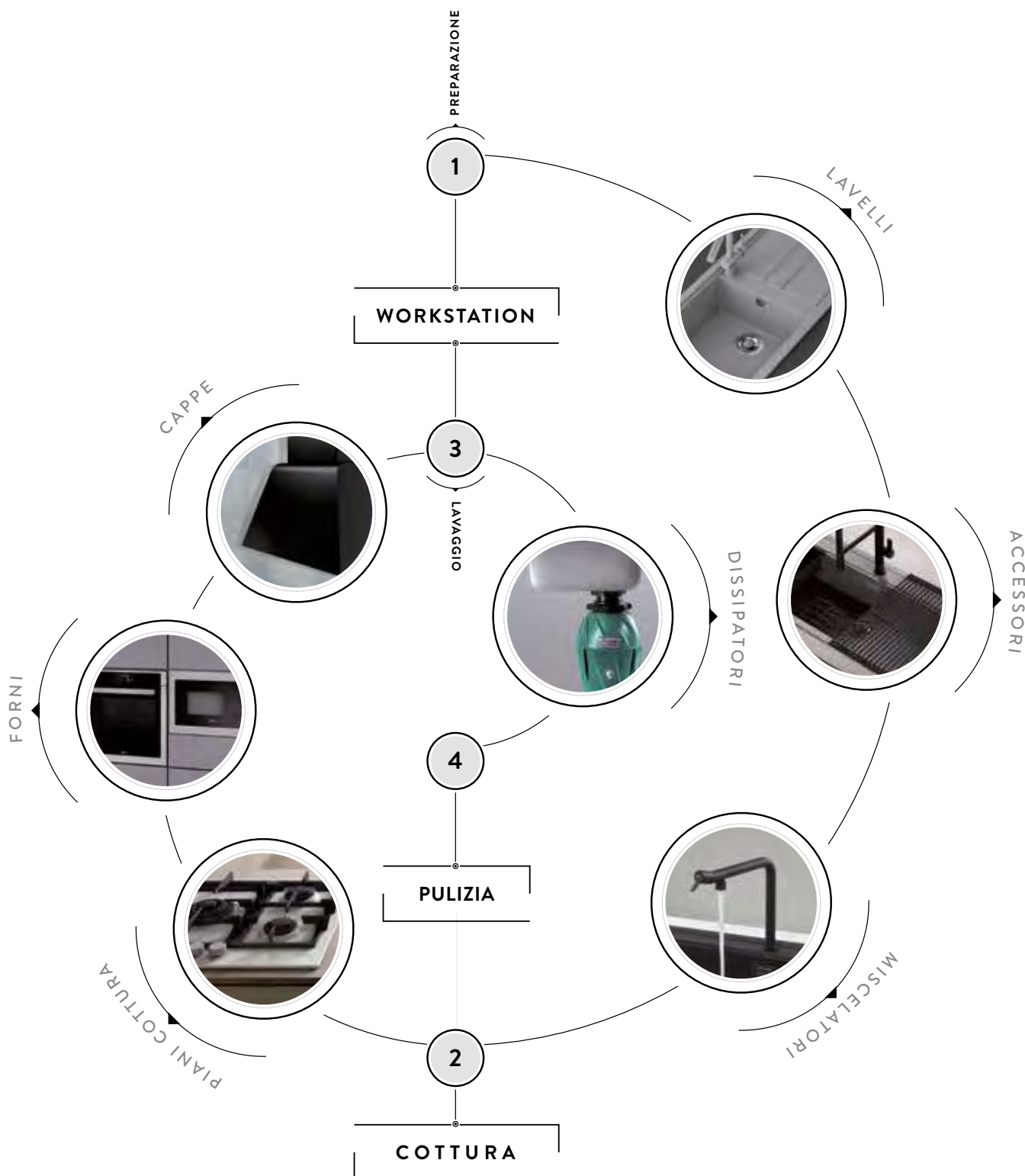



GLOBE 910

Progettato per essere EXTRA: la vasca XL, profonda e capiente, crea un ampio spazio di lavoro adatto per pentole grandi e teglie da forno. Il lavello è protagonista in ambienti sia moderni che classici.

PAG. 42



BEST 130

L'ergonomia prima di tutto: con una vera Workstation in Keratek Plus, installabile in una base da 80 cm e tanti accessori tra cui scegliere, tutto è davvero a portata di mano.

PAG. 79



BEST BUNDLE

Due accessori fondamentali per le operazioni del food preparing: Colander e Drainer Flex sono già inclusi nei prodotti denominati Best 360 Bundle e Best 130 Bundle.

Una comodità in più nella vita di ogni giorno.

PAG. 78-79



INTEGRA 102

Una vasca e un top: uno spazio che incorpora design e funzionalità, dove le differenze di materiale si integrano con un effetto estetico di sicuro impatto. Integra 102 è la vasca in Keratek Plus che si integra in cucine con spazi ridotti.

PAG. **67**



QUADRA 102

La quadratura della gamma: una misura di vasca in più (dimensione interna 40 x 40 cm) installabile sia Sopratop che Sottotop, che completa ed arricchisce la proposta Quadra.

PAG. **94-104**

SOPRATOP

SOTTOTOP

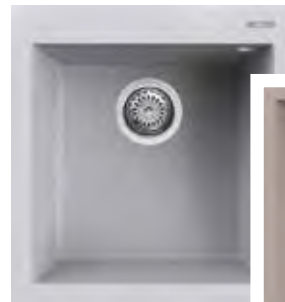

UNICO CORNER

Per risolvere eventuali problemi di spazio in cucine di piccole dimensioni, il lavello ad angolo è una possibilità da considerare. Unico Corner, con le sue due ampie vasche, è la soluzione giusta che coniuga funzionalità ed estetica.

PAG. **115**



IL TONO IDEALE PER ARREDARE **BLACK MATT**

la nuova finitura che mette tutti d'accordo

I trend più raffinati dell'arredamento moderno e di design contemplano la presenza del nero, sia come colore dominante della cucina, che come elemento di stile distintivo nei particolari. Gli accoppiamenti del nero con legni, marmi e top materici si rivelano sempre dei mix vincenti.

La nuova finitura Black Matt Elleci, presente su miscelatori e accessori, si caratterizza proprio per la sua capacità di interpretare queste tendenze stilistiche, proponendo nuovi accostamenti cromatici e valorizzando l'ambiente circostante.

La cromia Black Matt si accorda tono su tono con i lavelli realizzati in Keratek Plus K86 Black e in Granitek G40 Nero, sebbene possa essere utilizzata anche a contrasto con gli altri colori della gamma Elleci.





NEW

IL DESIGN È ESTETICA FUNZIONALE

FLOW PRO

Cambia il concetto di piletta in un sistema di scarico moderno, pratico, semplice nell'utilizzo e nella manutenzione.

SEAMLESS DESIGN

Conferisce al lavello continuità totale

EASY USE

L'ergonomia del comando centrale ne favorisce l'utilizzo con una sola mano

SMART CLEAN

Il design continuo elimina la possibilità di residui. Facilmente lavabile a mano o in lavastoviglie



Di serie sulle seguenti linee estetiche: Integra, Zen, Best e Best Workstation

LA PROTEZIONE PRIMA DI TUTTO



BIO MISCELATORI

Vedi pag. 188-189

Elleci presenta **BIO**, la nuova linea composta da quattro **miscelatori certificati antibatterici** grazie al trattamento specifico superficiale di **verniciatura a ioni d'argento**.

IGIENE ASSICURATA E BELLEZZA INTATTA



Ricerca e innovazione ci guidano verso soluzioni che garantiscono alte performance e benessere. I Miscelatori Bio rendono i batteri inefficaci al 99,9%: una tutela per la salute e la vita del prodotto.

Attraverso una tecnologia all'avanguardia basata sul trattamento superficiale di verniciatura a ioni d'argento, i microbi vengono immediatamente eliminati. Le piccole particelle aggrediscono la parete cellulare del batterio, fermandone la crescita e compromettendone anche la possibilità di replicarsi, attraverso un rapido processo di danneggiamento del DNA cellulare.

Un'azione duratura e particolarmente efficace che produce benefici per le persone, protette al massimo contro nemici invisibili, e per il prodotto stesso: l'agente antimicrobico diventa parte integrante del miscelatore custodendone il colore e l'originaria bellezza.

L'ABBINAMENTO IDEALE ESISTE DAVVERO

UN IMPATTO VISIVO CHE SORPRENDE
E CONQUISTA

La gamma cromatica di piani cottura e forni abbinabili ai lavelli in Keratek Plus si espande ancora di più. Materiali all'avanguardia e funzionalità di ogni singolo accessorio beneficiano del fascino di nuovi colori, grazie ai quali l'ambiente cucina assume un'atmosfera unica.

Curare ogni dettaglio significa andare oltre la tecnica, scegliere la bellezza per distinguersi. Realizziamo accessori appartenenti a diverse categorie in grado di coordinarsi esattamente con i colori dei nostri lavelli in composito. Una family line cromatica che genera armonia nell'area preparing, nella quale gli elementi, da entità separate, finalmente si realizzano nella loro totalità.



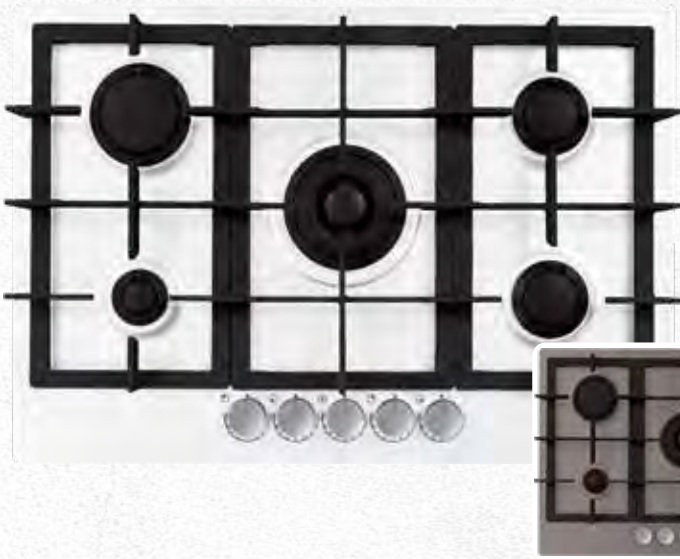

PLANO PLUS 75

PAG. 248

- K86
- K97
- K96
- K93



PLANO TOUCH

PAG. 237

- K86
- K97
- K96
- K93



LEAF PLUS

PAG. 235

- K86



PLANO PLUS

PAG. 238

- K86
- K97
- K96
- K93



LEAF TOUCH

PAG. 234

- K86
- K96



MICROONDE

PAG. 241

- K86
- K97
- K96
- K93



LEAF

PAG. 236

- K86



AL TUO FIANCO OGNI GIORNO

UN SET DI PRODOTTI CON SPECIFICHE CARATTERISTICHE, REALIZZATI PER FACILITARE LA PULIZIA E MANTENERE NEL TEMPO LA BELLEZZA DEI PRODOTTI ELLECI.

DAILY CLEANER è la linea pensata per le operazioni quotidiane, composta da tre soluzioni distinte: Active Sgrassante, indicato per lavelli in composito Keratek Plus e Granitek. Active Anticalcare, idoneo per lavelli in composito Keratek Plus e Granitek, oltre a lavelli in acciaio Inox. Clean Power, consigliato per miscelatori ed elettrodomestici.



LA PULIZIA FORMATO EXTRA

GLI INTERVENTI MIRATI RICHIEDONO SOLUZIONI ALTAMENTE EFFICACI

DEEP CLEANER è la linea studiata per operazioni periodiche incisive, create per prendersi cura di ogni materiale.

Si distinguono Extra Action per Keratek Plus e Extra Action per Granitek, creme delicate che assicurano la massima protezione dei lavelli.

Tutta la linea Elleci Beauty si completa con i panni in microfibra Fast Clean e le spugne Fast Clean, pensati e realizzati appositamente per l'applicazione dei prodotti Daily e Deep.

LUNGA VITA ALLE SOLUZIONI ELLECI

IL PROGRESSO SI FONDA SULLA CAPACITÀ DI SINTESI

Elleci For You è il modo più semplice e veloce per avvicinarsi a noi. Un rapporto di fiducia che si consolida, mantenendo la nostra promessa che parla di qualità, affidabilità e sicurezza.

Con la **registrazione online** del prodotto, ottieni l'estensione gratuita della **garanzia** convenzionale di **20 anni per il Keratek Plus** e **10 anni per il Granitek**.



20 ANNI

KERATEK[®] Plus
CERAMIC NANOTECHNOLOGY CN6

10 ANNI

GRANITEK[®]
NATURAL GRANITE EFFECT



Inquadra il QR code per accedere all'area registrazione prodotto.

GLOBE

Collezione

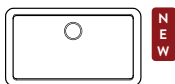

GLOBE 910
PAG. 42

DOGMA

Collezione

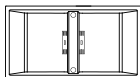

DOGMA 100
PAG. 48

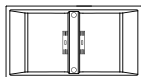

DOGMA 100 SLIM
PAG. 48

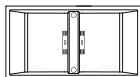

DOGMA 90
PAG. 49

SMART

Collezione

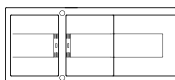

SMART 500
PAG. 54

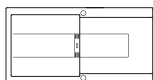

SMART 480
PAG. 54

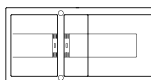

SMART 475
PAG. 55

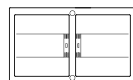

SMART 450
PAG. 55

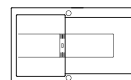

SMART 400
PAG. 56

VALUE

Collezione

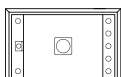

VALUE 130
SOPRATOP
PAG. 62

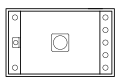

VALUE 130
SOTTOTOP
PAG. 62

KARISMA

Collezione

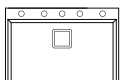

KARISMA 120
SOPRATOP
PAG. 68

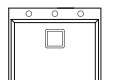

KARISMA 105
SOPRATOP
PAG. 68

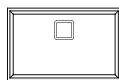

KARISMA 120
SOTTOTOP
PAG. 69

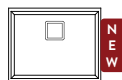

KARISMA 105
SOTTOTOP
PAG. 69

INTEGRA

Collezione

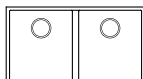

INTEGRA 350
PAG. 74

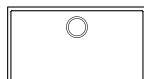

INTEGRA 130
PAG. 74

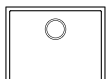

INTEGRA 105
PAG. 75



INTEGRA 102
PAG. 75

ZEN

Collezione

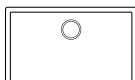

ZEN 130
PAG. 80

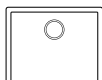

ZEN 105
PAG. 80



ZEN 102
PAG. 81

BEST WORKSTATION

Collezione

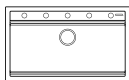

BEST 360
PAG. 86

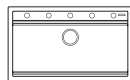

BEST 360 BUNDLE
PAG. 86

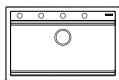

BEST 130
PAG. 87

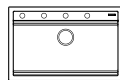

BEST 130 BUNDLE
PAG. 87

BEST

Collezione

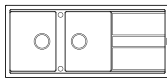

BEST 500
PAG. 92

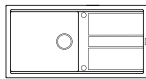

BEST 480
PAG. 92

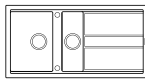

BEST 475
PAG. 93

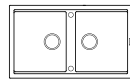

BEST 450
PAG. 93

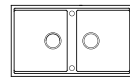

BEST 450
SOTTOTOP
PAG. 94

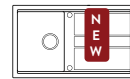

BEST 400
PAG. 94

QUADRA

Collezione

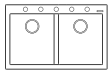

QUADRA 350
PAG. 100

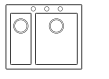

QUADRA 150
PAG. 100

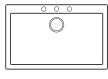

QUADRA 130
PAG. 101



QUADRA 110
PAG. 101



QUADRA 105
PAG. 102



QUADRA 102
PAG. 102

QUADRA

Collezione
Sottotop



QUADRA 100
PAG. 103



QUADRA 50
PAG. 103

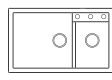

QUADRA 440
PAG. 104

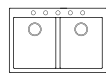

QUADRA 340
PAG. 104

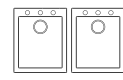

QUADRA 200
PAG. 105

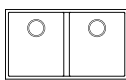

QUADRA 350
PAG. 110



QUADRA 150
PAG. 110



QUADRA 130
PAG. 111

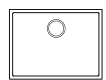

QUADRA 110
PAG. 111



QUADRA 105
PAG. 112



QUADRA 102
PAG. 112



QUADRA 100
PAG. 113



QUADRA 50
PAG. 113

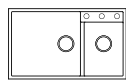

QUADRA 440
PAG. 114

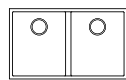

QUADRA 340
PAG. 114

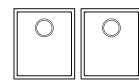

QUADRA 200
PAG. 115

UNICO

Collezione

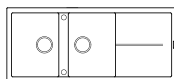

UNICO 500
PAG. 120

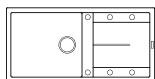

UNICO 480
PAG. 120

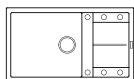

UNICO 410
PAG. 121

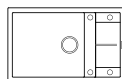

UNICO 310
PAG. 121

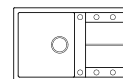

UNICO 300
PAG. 122

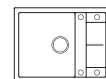

UNICO 125
PAG. 122

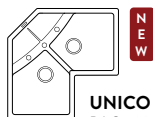

UNICO CORNER
PAG. 123

EGO

Collezione

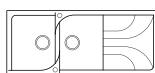

EGO 500
PAG. 128

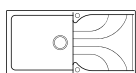

EGO 480
PAG. 128

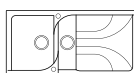

EGO 475
PAG. 129

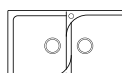

EGO 450
PAG. 129

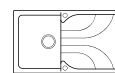

EGO 400
PAG. 130

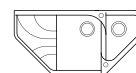

EGO ESA
PAG. 130

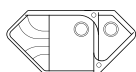

EGO CORNER
PAG. 131



EGO ROUND
PAG. 131

TEKNO

Collezione

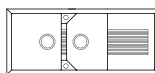

TEKNO 500
PAG. 136

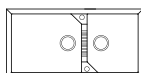

TEKNO 490
PAG. 136

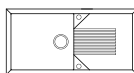

TEKNO 480
PAG. 137

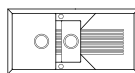

TEKNO 475
PAG. 137

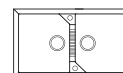

TEKNO 450
PAG. 138

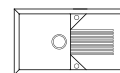

TEKNO 400
PAG. 138

EASY

Collezione

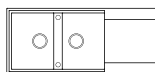

EASY 500
PAG. 144

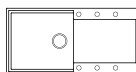

EASY 480
PAG. 144

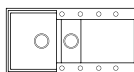

EASY 475
PAG. 145

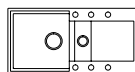

EASY 425
PAG. 145

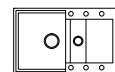

EASY 325
PAG. 146

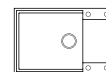

EASY 310
PAG. 146

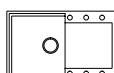

EASY 300
PAG. 147

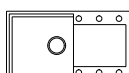

EASY 290
PAG. 147



EASY 150
PAG. 148



EASY 135
PAG. 148

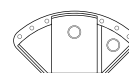

EASY CORNER
PAG. 149



EASY ROUND 600
PAG. 149

FOX

Collezione

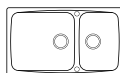

FOX 450
PAG. 154

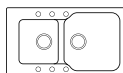

FOX 430
PAG. 154

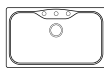

FOX 360
PAG. 155

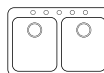

FOX 340
PAG. 155



FOX 330
PAG. 156



FOX 200
PAG. 156



FOX 180
PAG. 157



FOX ROUND
PAG. 157

MASTER

Collezione

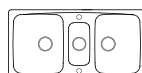

MASTER 550
PAG. 162

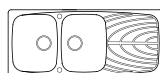

MASTER 500
PAG. 162

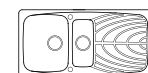

MASTER 475
PAG. 163

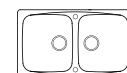

MASTER 450
PAG. 163

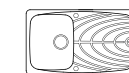

MASTER 400
PAG. 164

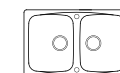

MASTER 350
PAG. 164

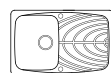

MASTER 300
PAG. 165

LIVING

Collezione

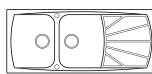

LIVING 500
PAG. 170

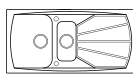

LIVING 475
PAG. 170

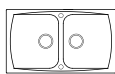

LIVING 450
PAG. 171

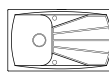

LIVING 400
PAG. 171

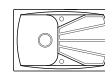

LIVING 300
PAG. 172



LIVING 125
PAG. 172

INDICE COLLEZIONI LAVELLI INOX

W-SQUARE

Collezione



W-SQUARE 700
PAG. 189

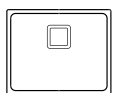

W-SQUARE 500
PAG. 189



W-SQUARE 400
PAG. 189

YOGA

Collezione

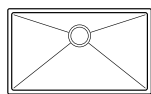

YOGA 700
PAG. 190

NEW

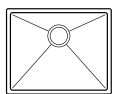

YOGA 500
PAG. 190

NEW

CUBE

Collezione

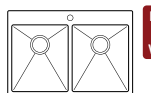

CUBE 750 2V
PAG. 191

NEW

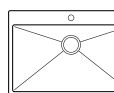

CUBE 700
PAG. 191

NEW



CUBE 500
PAG. 191

NEW

SKY

Collezione

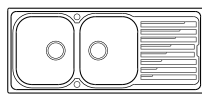

SKY 500
PAG. 192

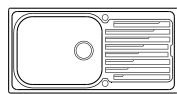

SKY 480
PAG. 192

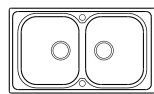

SKY 450
PAG. 192

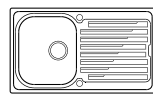

SKY 400
PAG. 192

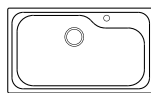

SKY 360
PAG. 193

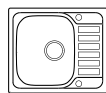

SKY 125
PAG. 193



SKY ROUND 435
PAG. 193

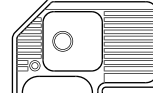

SKY CORNER
PAG. 193

INDICE COLLEZIONI ACCESSORI

ACCESSORI

ELEMENT

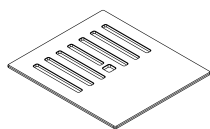

ELEMENT TAGLIERI
PAG. 168

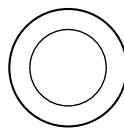

ELEMENT POP-UP
PAG. 171



ELEMENT DISPENSER
PAG. 172

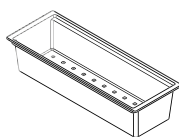

NEW

ELEMENT COLANDER
PAG. 173

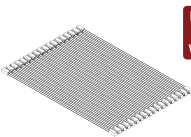

NEW

ELEMENT DRAINER FLEX
PAG. 173

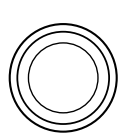

NEW

ELEMENT STYLE
PAG. 174



NEW

ELLECI BEAUTY
PAG. 175

ACCESSORI

VARI

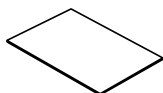

TAGLIERI
PAG. 178

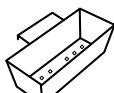

COLANDER
PAG. 178



CESTELLI
PAG. 178

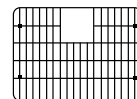

BOTTOM GRID
PAG. 179

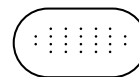

ALTRI ACCESSORI
PAG. 179

BIO NEW

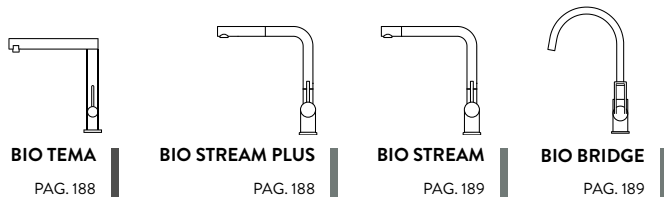

BIO TEMA | PAG. 188 | **BIO STREAM PLUS** | PAG. 188 | **BIO STREAM** | PAG. 189 | **BIO BRIDGE** | PAG. 189

DESIGN BLACK MATT NEW

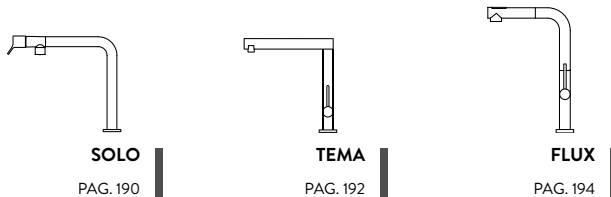

SOLO | PAG. 190 | **TEMA** | PAG. 192 | **FLUX** | PAG. 194

DESIGN



FLAT | PAG. 196 | **BLADE** | PAG. 196

PROFESSIONAL

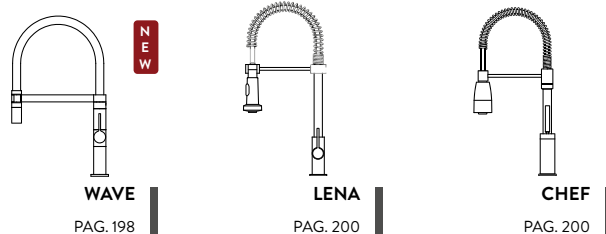

WAVE | PAG. 198 | **LENA** | PAG. 200 | **CHEF** | PAG. 200

FILTRANTE

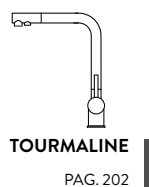

TOURMALINE | PAG. 202

RECLINABILI

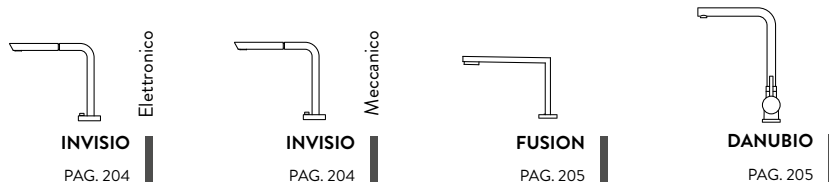

INVISIO | Electronico | PAG. 204 | **INVISIO** | Meccanico | PAG. 204 | **FUSION** | PAG. 205 | **DANUBIO** | PAG. 205

MODERN CANNA L



ARES | NEW | PAG. 206 | **STREAM** | PAG. 206 | **STREAM PLUS** | PAG. 207 | **TRAIL PLUS** | NEW | PAG. 208 | **TRAIL** | PAG. 208

MODERN CANNA CURVA

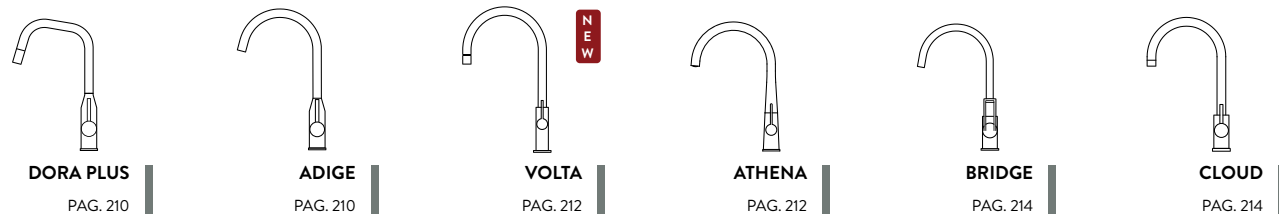

DORA PLUS | PAG. 210 | **ADIGE** | PAG. 210 | **VOLTA** | NEW | PAG. 212 | **ATHENA** | PAG. 212 | **BRIDGE** | PAG. 214 | **CLOUD** | PAG. 214

COUNTRY

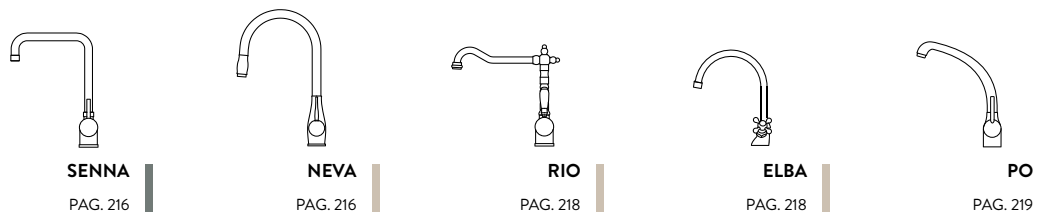

SENN | PAG. 216 | **NEVA** | PAG. 216 | **RIO** | PAG. 218 | **ELBA** | PAG. 218 | **PO** | PAG. 219

BASIC



RENO | PAG. 220 | **SAVA** | PAG. 220 | **VENERE** | PAG. 222 | **MINERVA** | PAG. 223 | **MINERVA 35** | PAG. 223

INDICE COLLEZIONI FORNI

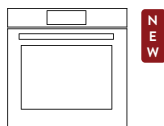

LEAF TOUCH
PAG. 234

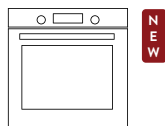

LEAF PLUS
PAG. 235

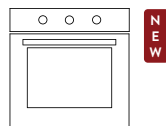

LEAF
PAG. 236

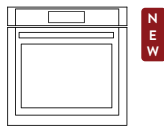

PLANO TOUCH
PAG. 237

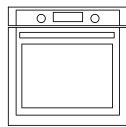

PLANO PLUS
PAG. 238

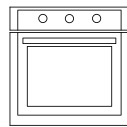

PLANO
PAG. 239

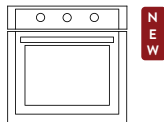

STYLE
PAG. 240

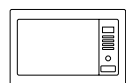

FORNO MICROONDE
PAG. 241

INDICE COLLEZIONI PIANI COTTURA

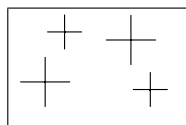

LEAF 80
PAG. 244

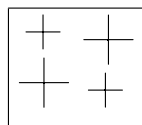

LEAF 60
PAG. 244

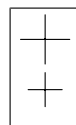

LEAF 30
PAG. 245

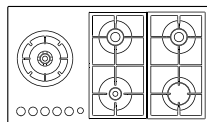

LEAF GAS ON GLASS 90
PAG. 246

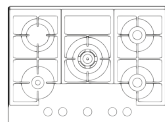

LEAF GAS ON GLASS 70
PAG. 246

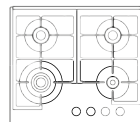

LEAF GAS ON GLASS 60
PAG. 247

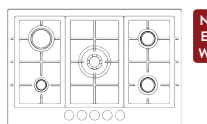

PLANO PLUS 75
PAG. 248

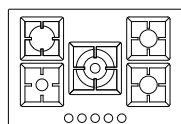

PLANO 75
PAG. 250

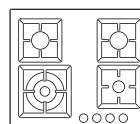

PLANO 60
PAG. 252

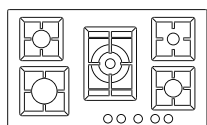

PLANO 90
PAG. 254

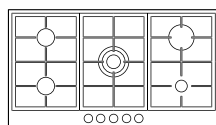

STYLE 90
PAG. 255

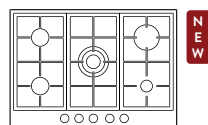

STYLE 75
PAG. 256

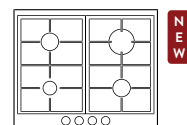

STYLE 60
PAG. 258

INDICE COLLEZIONI CAPPE

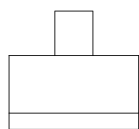

NEW

LEAF VERTICAL
PAG. 260

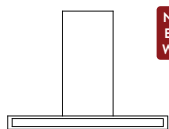

NEW

LEAF BOX
PAG. 260

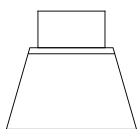

NEW

BRIO
PAG. 261

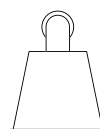

NEW

URBAN
PAG. 261

INDICE COLLEZIONI DISSIPATORI



MODELLO 1000 TOP
PAG. 264

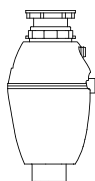

MODELLO 750 TOP
PAG. 264

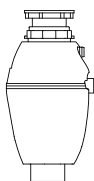

MODELLO 750
PAG. 264

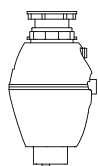

MODELLO 500 TOP
PAG. 265

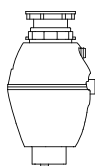

MODELLO 500
PAG. 265

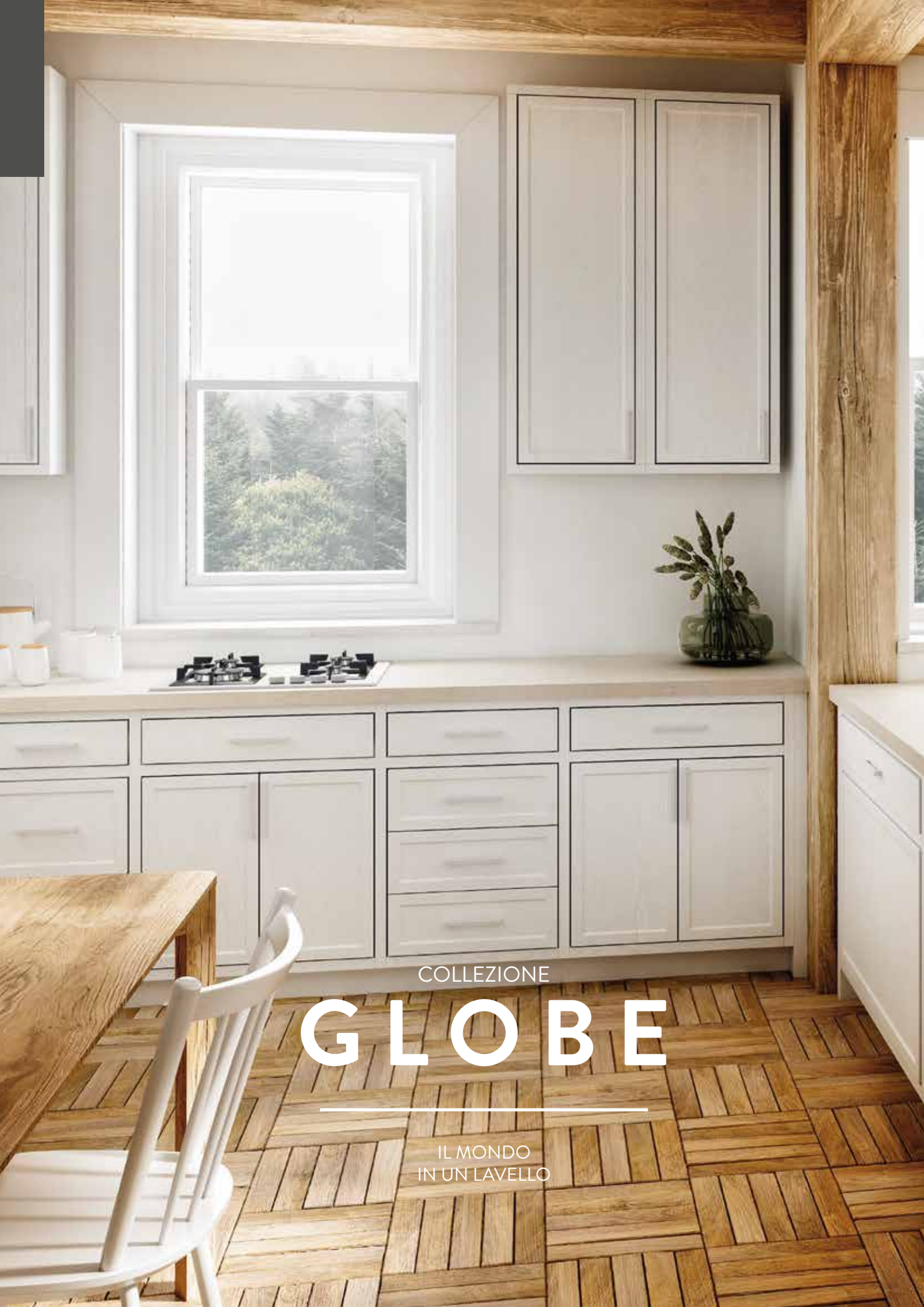

COLLEZIONE

GLOBE

IL MONDO
IN UN LAVELLO





COLLEZIONE
GLOBE

IL MONDO
IN UN LAVELLO

COLLEZIONE

GLOBE

Può un lavello contenere un mondo? Sì, se il lavello è un Globe. La sua vasca XL, profonda più di 23 cm è perfetta per ospitare stoviglie e pentole di grandi dimensioni. La versatilità estetica di Globe lo rende installabile sia in ambienti industrial e di design che in contesti più classici.



SOPRATOP



SOTTOTOP



Lavello Globe 910 G40 Nero con miscelatore Chef Cromato e accessorio Element Tagliere Globe 910 Olmo

900

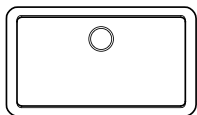

NEW

GLOBE 910

PAG. 42



DISEGNI TECNICI
APPROFONDITI
LINEA GLOBE

Corredo del lavello: Cover piletta materica, sifone salvaspazio e ganci.

GRANITEK
NATURAL GRANITE EFFECT

**G68** Bianco**G40** Nero**VASCA XL**

La vasca XL di Globe misura più di 23 cm di profondità ed è particolarmente indicata per contenere stoviglie e pentole di grandi dimensioni.

**ACCESSORI ELEMENT**

Il tagliere e il drainer flex permettono di completare il lavello a proprio gusto e piacimento, rendendo le operazioni di preparazione del cibo più facili e pratiche.

GLOBE 910 BIANCO



NEW

Lavello 1 vasca

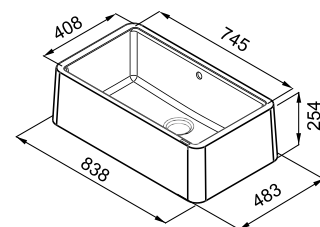

Disegno Tecnico approfondito: QR code a pag. 41



Installazione miscelatore sul top

CARATTERISTICHE

Dimensioni (mm)	838 x 483
Base (mm)	900
Foro da incasso (mm)	Sopratop da disegno
Foro da incasso (mm)	Sottotop da disegno
Profondità Vasca (mm)	235
Orientamento	Non reversibile

Cover Piletta Materica inclusa

ACCESSORI CONSIGLIATI



MATERIALI E COLORI

GRANITEK
NATURAL GRANITE EFFECT Euro **963**

MATT

○ G68 Bianco LGG91068BTP

ACCESSORIO CONSIGLIATO

**ELEMENT
TAGLIERE
GLOBE 910** Euro **123**

● Olmo ATHPL0900L



GLOBE 910 NERO



NEW

Lavello 1 vasca

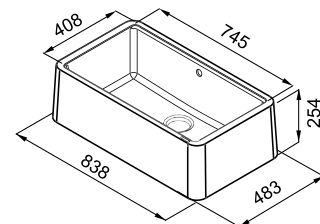

Disegno Tecnico approfondito: QR code a pag. 41



Installazione miscelatore sul top

CARATTERISTICHE

Dimensioni (mm)	838 x 483
Base (mm)	900
Foro da incasso (mm)	Sopratop da disegno
Foro da incasso (mm)	Sottotop da disegno
Profondità Vasca (mm)	235
Orientamento	Non reversibile

Cover Piletta Materica inclusa

ACCESSORI CONSIGLIATI



MATERIALI E COLORI

GRANITEK
NATURAL GRANITE EFFECT Euro **963**

MATT

● G40 Nero LGG91040BTP

ACCESSORIO CONSIGLIATO

**ELEMENT
TAGLIERE
GLOBE 910** Euro **123**

● Olmo ATHPL0900L



154 Element Tagliere
Globe 910



ATHPL0900L

Euro **123**

Pag. 170

157 Element Drainer Flex 440

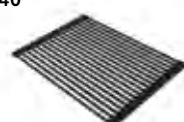

ARS013BK

Euro **80**

Pag. 174

160 Spray Detergente
Sgrassante Daily Clean



DLL01601

Pag. 175



Globe si adatta ad ogni situazione di arredamento; la sua particolare forma sporgente invita al suo completo utilizzo lasciando grande spazio all'interno della capiente vasca XL. In questa configurazione, presentiamo Globe 910 installato Soprato in G68 Bianco e miscelatore Rio Cromato.



E' possibile installare Globe anche Sottotop per un effetto ancora più sorprendente. In questo caso proponiamo Globe 910 in G40 Nero e miscelatore Solo Black Matt.





COLLEZIONE

DOGMA

IDEATO DALLA CREATIVITÀ
ITALIANA

COLLEZIONE

DOGMA

Principio di stile dalla indiscutibile funzionalità e straordinaria bellezza, Dogma rappresenta l'inconfondibile esempio del design che dall'idea prende forma.



LAVELLO
OVER-TOP



LAVELLO
OVER-TOP SLIM



Lavello Dogma 90 K96 White con miscelatore Invisio Meccanico Cromato

900

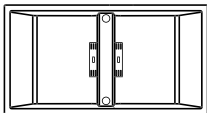

DOGMA 100
PAG. 48

900

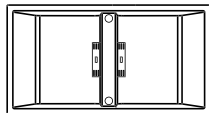

DOGMA 100 SLIM
PAG. 48

900

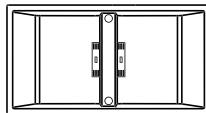

DOGMA 90
PAG. 49



DISEGNI TECNICI
APPROFONDITI
LINEA DOGMA

Corredo del lavello: Sistema di scarico S.I.R. completo, sifone, gancio e cestello incluso.

KERATEK^{Plus}
CERAMIC NANOTECHNOLOGY CN6



K99 Dark Grey



K96 White



K86 Black



OVER-TOP

Ha rivoluzionato la modalità di incasso del tradizionale lavello. Utilizzando le dimensioni foro incasso standard, si ottengono 94 cm di lunghezza, aumentando la capacità delle vasche.



S.I.R.

Innovativo e brevettato sistema di Scarico ad Ingombro Ridotto che permette di ottimizzare la parte sottostante il lavello grazie al limitato ingombro di 5 cm.



VASCA XL

Vasca dallo spazio ampio e maggiorato per ospitare utensili di grandi dimensioni e facilitare le operazioni di utilizzo.

DOGMA 100



Accessorio incluso



Over-Top 70 mm



Lavello 2 vasche

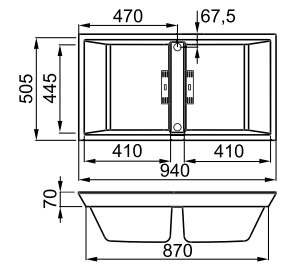

Disegno Tecnico approfondito: QR code a pag. 47

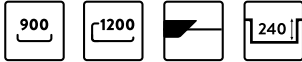

CARATTERISTICHE

Dimensioni (mm)	940 x 505
Base (mm)	900
- se inizio composizione	1200
Foro da incasso (mm)	840 x 480
Profondità Vasca 1 (mm)	240
Profondità Vasca 2 (mm)	240
Orientamento	Reversibile

MATERIALI E COLORI

KERATEK plus
CERAMIC NANOTECHNOLOGY GNB

Euro **1028**

- K99 Dark Grey EKD1009999M
- K96 White EKD1009696M
- K86 Black EKD1008686M

ACCESSORI CONSIGLIATI

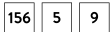

DOGMA 100 SLIM



Accessorio incluso



Over-Top 50 mm



Lavello 2 vasche

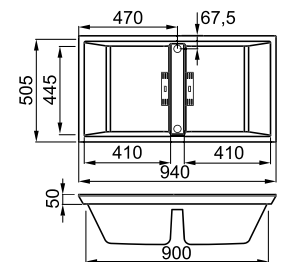

Disegno Tecnico approfondito: QR code a pag. 47



CARATTERISTICHE

Dimensioni (mm)	940 x 505
Base (mm)	900
- se inizio composizione	1200
Foro da incasso (mm)	860 x 480
Profondità Vasca 1 (mm)	240
Profondità Vasca 2 (mm)	240
Orientamento	Reversibile

MATERIALI E COLORI

KERATEK plus
CERAMIC NANOTECHNOLOGY GNB

Euro **973**

- K99 Dark Grey EKD1009999MSLM
- K96 White EKD1009696MSLM
- K86 Black EKD1008686MSLM

ACCESSORI CONSIGLIATI

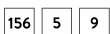

156 Element Drainer Flex 500

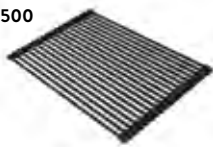

ARS023BK
Euro **88**
Pag. 173

5 Colander



AVI03001
Euro **126**
Pag. 178

9 Scolapiatti



ADI01300
Euro **48**
Pag. 179

DOGMA 90

Lavello 2 vasche



Accessorio incluso

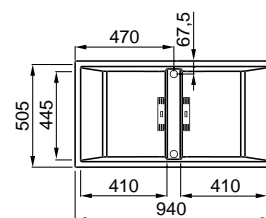

Disegno Tecnico approfondito: QR code a pag. 47

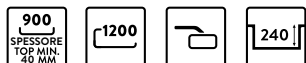

MATERIALI E COLORI

KERATEK plus
CERAMIC NANOTECHNOLOGY ONE

Euro 1006

- K99 Dark Grey EKD09099M
- K96 White EKD09096M
- K86 Black EKD09086M

CARATTERISTICHE

Dimensioni (mm)	940 x 505
Base (mm)	900
- se inizio composizione	1200
Foro da incasso (mm)	925 x 495
Profondità Vasca 1 (mm)	240
Profondità Vasca 2 (mm)	240
Orientamento	Reversibile

ACCESSORI CONSIGLIATI

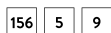

150 Crema Smacchiante Deep
Clean Lavelli Keratek



DLC01602

Pag. 175

162 Panni in Microfibra
Fast Clean

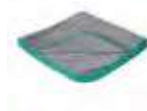

DKP01001

Pag. 177



COLLEZIONE

VALUE

UN PROGETTO ESSENZIALE,
UNICO, SENZA TEMPO.

COLLEZIONE

VALUE

Organizzare, nascondere e modellare l'area lavaggio non è mai stato così facile e piacevole.



SOPRATOP



SOTTOTOP

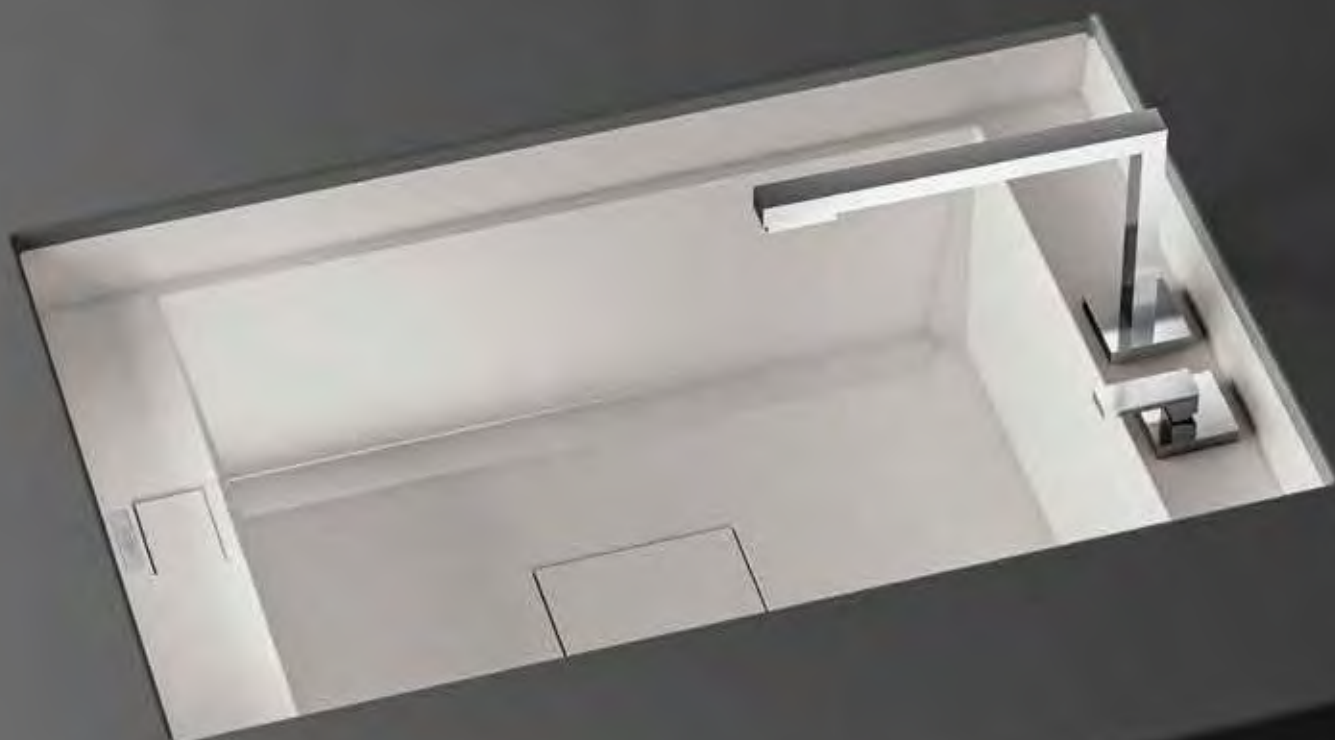

Lavello Value 130 Sottotop G68 Bianco con miscelatore Fusion Cromato

800

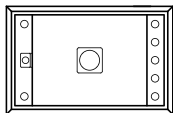
**VALUE 130**

PAG. 54

800

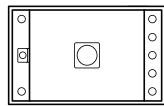
**VALUE 130**

SOTTOTOP

PAG. 54



DISEGNI TECNICI
APPROFONDITI
LINEA VALUE

Corredo del lavello: Sifone salvaspazio, pilette e ganci. Cover piletta e cover troppopieno in HPL.

GRANITEK
NATURAL GRANITE EFFECT

**G68** Bianco**G40** Nero**PRISMA CLEAN**

Il sistema Prisma-clean sostituisce le classiche raggiature interne con facce prismatiche che ammorbidiscono e facilitano la pulizia delle aree interne della vasca, mantenendo un deciso carattere estetico.

**AREA ACCESSORI INTEGRATA**

Area dotata di prefori che permette di installare una molteplicità di accessori: piletta salterello, miscelatore, dispenser del sapone ad ingombro ridotto e doghe modulari a scomparsa.

**TROPPOPIENO E PILETTA A SCOMPARSA**

Grazie alle cover realizzate in HPL, il troppopieno e la piletta sono a scomparsa e perfettamente integrati nella water zone.

**ELEMENT KIT DOGHE IN HPL**

Per completare l'estetica a scomparsa di Value, le doghe in HPL sono la soluzione ideale. Disposte sul lavello agiscono da tagliere o da supporto, mentre per riporle è sufficiente posizionarle una sull'altra.

VALUE 130

Lavello 1 vasca

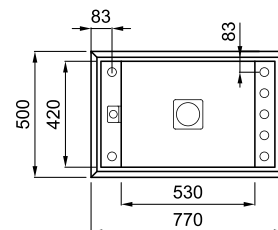

Disegno Tecnico approfondito: QR code a pag. 53



CARATTERISTICHE

Dimensioni (mm)	770 x 500
Base (mm)	800
Foro da incasso (mm)	750 x 480
Profondità Vasca (mm)	220
Orientamento	Reversibile

MATERIALI E COLORI

GRANITEK
NATURAL GRANITE EFFECT Euro **575**

MATT

- G68 Bianco LGV13068
- G40 Nero LGV13040

ELEMENT KIT DOGHE IN HPL Euro 102

- White ATH083WH
- Black ATH083BK



ACCESSORI CONSIGLIATI

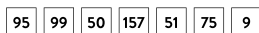

VALUE 130 SOTTOTOP

Lavello 1 vasca

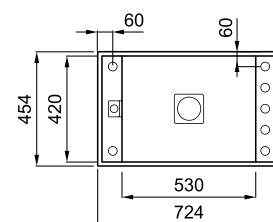

Disegno Tecnico approfondito: QR code a pag. 53



CARATTERISTICHE

Dimensioni (mm)	724 x 454
Base (mm)	800
Foro da incasso (mm)	692 x 422 R2
Profondità Vasca (mm)	220
Orientamento	Reversibile

MATERIALI E COLORI

GRANITEK
NATURAL GRANITE EFFECT Euro **612**

MATT

- G68 Bianco LGV13068BSO
- G40 Nero LGV13040BSO

ELEMENT KIT DOGHE IN HPL Euro 102

- White ATH083WH
- Black ATH083BK



ACCESSORI CONSIGLIATI

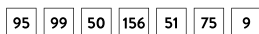

99 Element Pop-Up
Cube Value



ASP17000
Euro **90**
Pag. 172

157 Element Drainer Flex 440

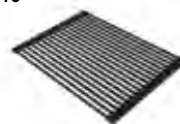

ARS013BK
Euro **77**
Pag. 174

Solo Value 130

156 Element Drainer Flex 500

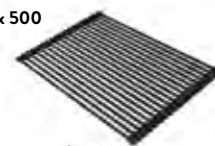

ARS023BK
Euro **85**
Pag. 173

Solo Value 130
Sottotop



Value 130 con
accessorio Element Kit Doghe

51 Colander Value

AVI03303
Euro **138**
Pag. 178



50 Element Dispenser
Sapone Quadrato

ADI02301
Euro **98**
Pag. 172



160 Spray Detergente
Sgrassante Daily Clean

DLL01601
Pag. 175





pietra care
solution
TOM FORD

COLLEZIONE

KARISMA

DESIGN CARISMATICO



COLLEZIONE

KARISMA

Bordo "svasato" che invita ad un uso più armonioso del lavello.

Pur mantenendo linee rette e decise, il design interviene per donare funzionalità e praticità.

Lo smusso interno di 45°, che congiunge il bordo all'interno vasca, facilita le operazioni di PREPARING, CLEANING e COOKING nella Water Zone.



SOPRATOP



SOTTOTOP



Lavello Karisma 105 G40 Nero con miscelatore Tourmaline G40 Nero

800

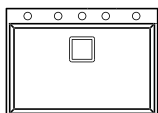

KARISMA 120
PAG. 60

600

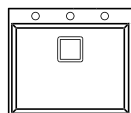

KARISMA 105
PAG. 60

800

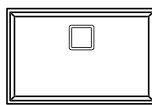

KARISMA 120
SOTTOTOP
PAG. 61

600

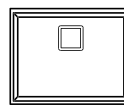

KARISMA 105
SOTTOTOP
PAG. 61



DISEGNI TECNICI
APPROFONDITI
LINEA KARISMA

Corredo del lavello: Sifone salvaspazio, piletta quadrata, troppopieno rettangolare e ganci.

KERATEK^{Plus}
CERAMIC NANOTECHNOLOGY CN6



K99 Dark Grey

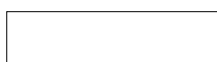

K96 White



K86 Black

GRANITEK
NATURAL GRANITE EFFECT

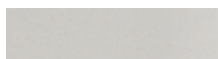

M79 Aluminium



M73 Titanium

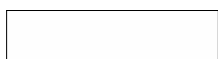

G68 Bianco

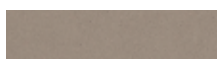

G43 Tortora



G40 Nero



PILETTA QUADRATA

Le linee squadrate e razionali di Karisma trovano l'ideale complemento estetico nella piletta quadrata che diventa elemento distintivo e rilevante.



**TROPPOPIENO
RETTANGOLARE**

Il troppopieno rettangolare, progettato per un miglior deflusso dell'acqua e posizionato al centro della vasca, è un dettaglio di stile inconfondibile che migliora anche le funzionalità.



**AREA ACCESSORI
INTEGRATA**

Area dotata di prefori che permette di installare una molteplicità di accessori: piletta salterello, miscelatore, dispenser del sapone ad ingombro ridotto.

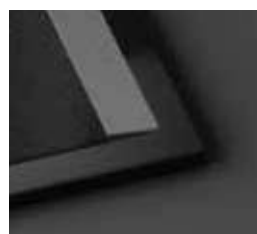

BORDO K

Nell'installare l'innovativo lavello Karisma in modalità sottotop si ottiene un elevato impatto estetico che differisce da tutte le vasche quadre fino ad oggi realizzate.

KARISMA 120



Lavello 1 vasca

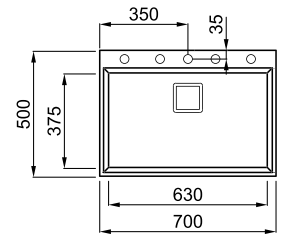

Disegno Tecnico approfondito: QR code a pag. 59



CARATTERISTICHE

Dimensioni (mm)	700 x 500
Base (mm)	800
Foro da incasso (mm)	680 x 480
Profondità Vasca (mm)	220
Orientamento	Non reversibile

ACCESSORI CONSIGLIATI



MATERIALI E COLORI

KERATEK plus
CERAMIC NANOTECHNOLOGY CN8 Euro **584**

- K99 Dark Grey LKK12099
- K96 White LKK12096
- K86 Black LKK12086

GRANITEK
NATURAL GRANITE EFFECT Euro **452**

METAL

- M79 Aluminium LMK12079
- M73 Titanium LMK12073

GRANITEK
NATURAL GRANITE EFFECT Euro **431**

MATT

- G68 Bianco LGK12068
- G43 Tortora LGK12043
- G40 Nero LGK12040

KARISMA 105



Lavello 1 vasca

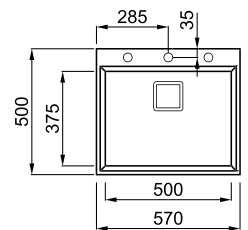

Disegno Tecnico approfondito: QR code a pag. 59



CARATTERISTICHE

Dimensioni (mm)	570 x 500
Base (mm)	600
Foro da incasso (mm)	550 x 480
Profondità Vasca (mm)	220
Orientamento	Non reversibile

ACCESSORI CONSIGLIATI

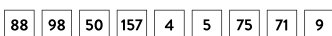

MATERIALI E COLORI

KERATEK plus
CERAMIC NANOTECHNOLOGY CN8 Euro **475**

- K99 Dark Grey LKK10599
- K96 White LKK10596
- K86 Black LKK10586

GRANITEK
NATURAL GRANITE EFFECT Euro **368**

METAL

- M79 Aluminium LMK10579
- M73 Titanium LMK10573

GRANITEK
NATURAL GRANITE EFFECT Euro **350**

MATT

- G68 Bianco LGK10568
- G43 Tortora LGK10543
- G40 Nero LGK10540

88 Element Tagliere
Sliding 50cm



ATH010QU
Euro **147**
Pag. 168

Solo per Karisma
120 e 105

50 Element Dispenser
Sapone Quadrato



ADI02301
Euro **102**
Pag. 172

Solo per Karisma
120 e 105

157 Element Drainer Flex 440

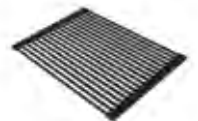

ARS013BK
Euro **80**
Pag. 174

KARISMA 120 SOTTOTOP

Lavello 1 vasca

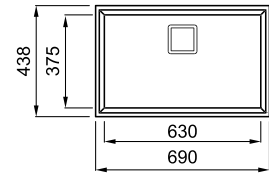

Disegno Tecnico approfondito: QR code a pag. 59



Installazione miscelatore sul top

CARATTERISTICHE

Dimensioni (mm)	690 x 438
Base (mm)	800
Foro da incasso (mm)	664 x 411 R5
Profondità Vasca (mm)	220
Orientamento	Non reversibile

MATERIALI E COLORI

KERATEK plus
CERAMIC NANOTECHNOLOGY CNG

● K99 Dark Grey	LKK12099BSO	Euro 606
○ K96 White	LKK12096BSO	
● K86 Black	LKK12086BSO	

GRANITEK
NATURAL GRANITE EFFECT

METAL		Euro 470
● M79 Aluminium	LMK12079BSO	
● M73 Titanium	LMK12073BSO	

GRANITEK
NATURAL GRANITE EFFECT

MATT

○ G68 Bianco	LGK12068BSO	Euro 452
● G43 Tortora	LGK12043BSO	
● G40 Nero	LGK12040BSO	

ACCESSORI CONSIGLIATI



KARISMA 105 SOTTOTOP

Lavello 1 vasca

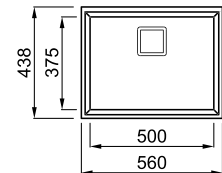

Disegno Tecnico approfondito: QR code a pag. 59



Installazione miscelatore sul top

CARATTERISTICHE

Dimensioni (mm)	560 x 438
Base (mm)	600
Foro da incasso (mm)	534 x 411 R5
Profondità Vasca (mm)	220
Orientamento	Non reversibile

MATERIALI E COLORI

KERATEK plus
CERAMIC NANOTECHNOLOGY CNG

● K99 Dark Grey	LKK10599BSO	Euro 494
○ K96 White	LKK10596BSO	
● K86 Black	LKK10586BSO	

GRANITEK
NATURAL GRANITE EFFECT

METAL		Euro 383
● M79 Aluminium	LMK10579BSO	
● M73 Titanium	LMK10573BSO	

GRANITEK
NATURAL GRANITE EFFECT

MATT

○ G68 Bianco	LGK10568BSO	Euro 364
● G43 Tortora	LGK10543BSO	
● G40 Nero	LGK10540BSO	

ACCESSORI CONSIGLIATI

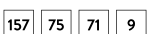

75 Cestello

ACI01307
Euro **101**
Pag. 178



5 Colander

AVI03001
Euro **126**
Pag. 178



Solo per Karisma
120 e 105

158 Spray Anticalcare
Disincrostante Daily Clean

DLA01601
Pag. 176







COLLEZIONE

INTEGRA

DESIGN MODERNO CHE SVELA
L'ECCELLENZA

COLLEZIONE

INTEGRA

Una linea sottotop con la possibilità di integrazione con il piano lavoro.
L'utilizzo di componenti come la piletta Flow Pro ed il troppopieno rettangolare
contribuiscono a conferire a questa collezione un aspetto elegante dal design minimale.



SOTTOTOP



INTEGRATA



Lavello Integra 102 K99 Dark Grey con Flux Cromato

800

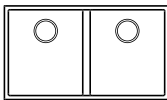

INTEGRA 350
PAG. 66

800

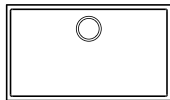

INTEGRA 130
PAG. 66

600

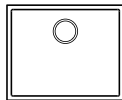

INTEGRA 105
PAG. 67

500

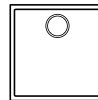

NEW

INTEGRA 102
PAG. 67



DISEGNI TECNICI
APPROFONDITI
LINEA INTEGRA

Corredo del lavello: Sifone salvaspazio, piletta Flow Pro integrata e troppopieno rettangolare.

KERATEK^{Plus}
CERAMIC NANOTECHNOLOGY CN6



K99 Dark Grey



K96 White



K93 Dove Grey



K86 Black



**GIUNZIONE
INVISIBILE**

La giunzione invisibile e i raggi minimal rendono il lavello In-tegra una presenza di raffinato design, in grado di esaltare il carattere dello spazio domestico.



PILETTA FLOW PRO

Inclusa a corredo, la piletta Flow Pro completa il prodotto, armonizzandosi con la vasca ed elevando l'armonia estetica delle linee di design.



**TROPPOPIENO
RETTANGOLARE**

Il troppopieno rettangolare, progettato per un miglior deflusso dell'acqua e posizionato al centro della vasca, è un dettaglio di stile inconfondibile che migliora anche le funzionalità.

INTEGRA 350

Lavello 2 vasche

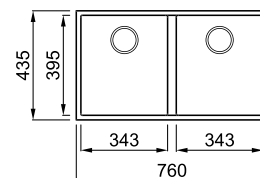

Disegno Tecnico approfondito: QR code a pag. 65



Installazione miscelatore sul top

CARATTERISTICHE

Dimensioni (mm)	760 x 435
Base (mm)	800
Foro da incasso (mm)	Integrato da disegno
Foro da incasso (mm)	Sottotop da disegno
Profondità Vasca 1 (mm)	220
Profondità Vasca 2 (mm)	220
Orientamento	Non reversibile

MATERIALI E COLORI

KERATEK plus CERAMIC NANOTECHNOLOGY CNS	Euro 622
● K99 Dark Grey	LKQ35099BIN
○ K96 White	LKQ35096BIN
● K93 Dove Grey	LKQ35093BIN
● K86 Black	LKQ35086BIN

ACCESSORI CONSIGLIATI

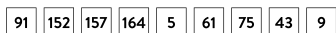

INTEGRA 130

Lavello 1 vasca

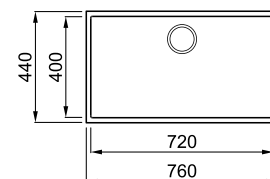

Disegno Tecnico approfondito: QR code a pag. 65



Installazione miscelatore sul top

CARATTERISTICHE

Dimensioni (mm)	760 x 440
Base (mm)	800
Foro da incasso (mm)	Integrato da disegno
Foro da incasso (mm)	Sottotop da disegno
Profondità Vasca (mm)	200
Orientamento	Non reversibile

MATERIALI E COLORI

KERATEK plus CERAMIC NANOTECHNOLOGY CNS	Euro 543
● K99 Dark Grey	LKQ13099BIN
○ K96 White	LKQ13096BIN
● K93 Dove Grey	LKQ13093BIN
● K86 Black	LKQ13086BIN

ACCESSORI CONSIGLIATI

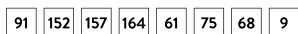

91 Element
Tagliere 420



ATH040BK
Euro **123**
Pag. 169

157 Element Drainer Flex 440

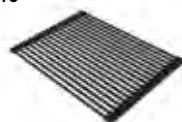

ARS013BK
Euro **80**
Pag. 174

152 Element
Colander 418



AVP035BK
Euro **64**
Pag. 173

INTEGRA 105

Lavello 1 vasca

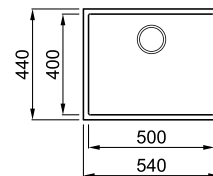

Disegno Tecnico approfondito: QR code a pag. 65



Installazione miscelatore sul top

CARATTERISTICHE

Dimensioni (mm)	540 x 440
Base (mm)	600
Foro da incasso (mm)	Integrato da disegno
Foro da incasso (mm)	Sottotop da disegno
Profondità Vasca (mm)	200
Orientamento	Non reversibile

MATERIALI E COLORI

KERATEK plus
CERAMIC NANOTECHNOLOGY CNG

Euro **492**

● K99 Dark Grey	LKQ10599BIN
○ K96 White	LKQ10596BIN
● K93 Dove Grey	LKQ10593BIN
● K86 Black	LKQ10586BIN

ACCESSORI CONSIGLIATI

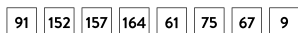

INTEGRA 102

Lavello 1 vasca



NEW

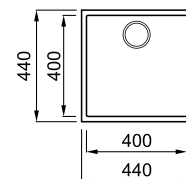

Disegno Tecnico approfondito: QR code a pag. 65



Installazione miscelatore sul top

CARATTERISTICHE

Dimensioni (mm)	440 x 440
Base (mm)	500
Foro da incasso (mm)	Integrato da disegno
Foro da incasso (mm)	Sottotop da disegno
Profondità Vasca (mm)	200
Orientamento	Non reversibile

MATERIALI E COLORI

KERATEK plus
CERAMIC NANOTECHNOLOGY CNG

Euro **492**

● K99 Dark Grey	LKQ10299BIN
○ K96 White	LKQ10296BIN
● K93 Dove Grey	LKQ10293BIN
● K86 Black	LKQ10286BIN

ACCESSORI CONSIGLIATI

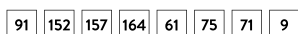

164 Element Kit Piletta e Troppopieno Black



COMPP90CTPLUXABK

Euro **74**

Pag. 174

Bottom Grid

Euro

AGB01303 **104** **68**

AGB01304 **88** **67**

AGB01306 **78** **71**

Pag. 179

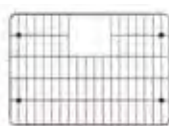

68 **67** **71**

1130 1105 1102

150 Crema Smacchiante Deep Clean Lavelli Keratek



DLC01602

Pag. 175





COLLEZIONE

ZEN

DESIGN SENZA TEMPO:
LESS IS MORE

COLLEZIONE
ZEN

Il design senza tempo per dirsi tale deve resistere alle mode passeggere e deve potersi armonizzare con un'ampia varietà di ambienti. Abbiamo sviluppato una nuova linea che sottolinea sia la tecnologia sia la cura dei dettagli di Elleci e che si distingue dalla concorrenza grazie alla propria versatilità di utilizzo. In una parola... ZEN



SOPRATOP



SOTTOTOP



Lavello Zen 130 K96 White con miscelatore Solo BK Black Matt

800

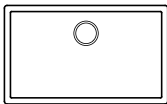

ZEN 130
PAG. 72

600

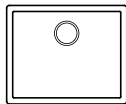

ZEN 105
PAG. 72

450

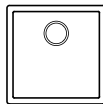

ZEN 102
PAG. 73



DISEGNI TECNICI
APPROFONDITI
LINEA ZEN

Corredo del lavello: Sifone salvaspazio, piletta Flow Pro integrata, troppopieno rettangolare, ganci e kit montaggio Sottotop.

KERATEK^{Plus}
CERAMIC NANOTECHNOLOGY CN6



K99 Dark Grey



K97 Light Grey

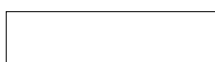

K96 White



K95 Champagne



K93 Dove Grey



K86 Black



SMART EDGE 6 MM

Lo spessore del bordo di Zen è ribassato a 6 mm, in linea con i più ricercati trend stilistici del minimalismo contemporaneo.



**PILETTA FLOW PRO INTEGRATA
E TROPPOPIENO
RETTANGOLARE INTEGRATO**

Due elementi di stile ed eleganza già inclusi nel corredo del lavello. La piletta Flow Pro integrata e il troppopieno rettangolare incorporano design e funzionalità.



ACCESSORI ELEMENT

Tagliere, drainer flex e colander permettono di completare il lavello a proprio gusto e piacimento, rendendo le operazioni di preparazione del cibo più facili e pratiche.

ZEN 130

Lavello 1 vasca

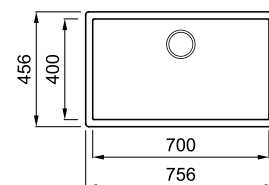

Disegno Tecnico approfondito: QR code a pag. 71



Installazione miscelatore sul top

CARATTERISTICHE

Dimensioni (mm)	756 x 456
Base (mm)	800
Foro da incasso (mm)	Sopratop 745 x 445 R5
Foro da incasso (mm)	Sottotop 700 x 400 R10
Profondità Vasca (mm)	200
Orientamento	Non reversibile

MATERIALI E COLORI

KERATEK CERAMIC NANOTECHNOLOGY CNE	Euro 567
● K99 Dark Grey	LKZ13099
● K97 Light Grey	LKZ13097
○ K96 White	LKZ13096
● K95 Champagne	LKZ13095
● K93 Dove Grey	LKZ13093
● K86 Black	LKZ13086

ACCESSORI CONSIGLIATI

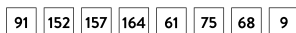

ZEN 105

Lavello 1 vasca

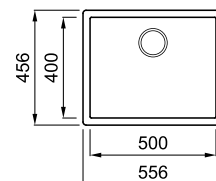

Disegno Tecnico approfondito: QR code a pag. 71



Installazione miscelatore sul top

CARATTERISTICHE

Dimensioni (mm)	556 x 456
Base (mm)	600
Foro da incasso (mm)	Sopratop 545 x 445 R5
Foro da incasso (mm)	Sottotop 500 x 400 R10
Profondità Vasca (mm)	200
Orientamento	Non reversibile

MATERIALI E COLORI

KERATEK CERAMIC NANOTECHNOLOGY CNE	Euro 515
● K99 Dark Grey	LKZ10599
● K97 Light Grey	LKZ10597
○ K96 White	LKZ10596
● K95 Champagne	LKZ10595
● K93 Dove Grey	LKZ10593
● K86 Black	LKZ10586

ACCESSORI CONSIGLIATI

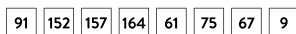

91 Element
Tagliere 420



ATH040OL
Euro **123**
Pag. 169

157 Element Drainer Flex 440

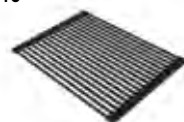

ARS013BK
Euro **77**
Pag. 174

152 Element
Colander 418



AVP035BK
Euro **64**
Pag. 173

ZEN 102

Lavello 1 vasca

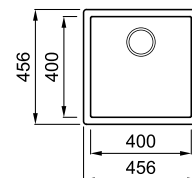

Sopratop Sottotop

Installazione miscelatore sul top

CARATTERISTICHE

Dimensioni (mm)	456 x 456
Base (mm)	Sopratop 450
Base (mm)	Sottotop 500
Foro da incasso (mm)	Sopratop 445 x 445 R5
Foro da incasso (mm)	Sottotop 400 x 400 R10
Profondità Vasca (mm)	200
Orientamento	Non reversibile

MATERIALI E COLORI

KERATEK plus
CERAMIC NANOTECHNOLOGY CNG

Euro **465**

	K99 Dark Grey	LKZ10299
	K97 Light Grey	LKZ10297
	K96 White	LKZ10296
	K95 Champagne	LKZ10295
	K93 Dove Grey	LKZ10293
	K86 Black	LKZ10286

Disegno Tecnico approfondito: QR code a pag. 71

ACCESSORI CONSIGLIATI

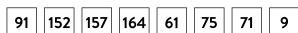

75 Cestello



ACI01307

Euro **97**

Pag. 178

164 Element Kit Piletta e Troppopieno Black



COMP90CTPLUXABK

Euro **71**

Pag. 174

150 Crema Smacchiante Deep Clean Lavelli Keratek



DLC01602

Pag. 175



COLLEZIONE

BEST WORKSTATION

POI TUTTO È POSSIBILE

COLLEZIONE

BEST WORKSTATION

Una cucina ben organizzata è un'ottima base di partenza per realizzare ogni ricetta: la Best Workstation si compone di una vasca XL e di una serie di accessori progettati appositamente per avere tutto a portata di mano. Il colander in polipropilene, il Drainer Flex in silicone (entrambi in dotazione sui modelli Bundle), il tagliere in HPL, il pop-up control rendono tutto più semplice e realizzabile.



SOPRATOP



Lavello Best 130 Bundle K86 Black (Colander e Drainer Flex inclusi) con miscelatore Wave Cromato

900

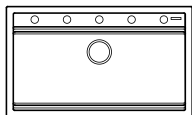

BEST 360
PAG. 78

900

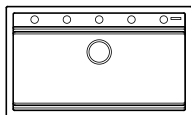

BEST 360 BUNDLE
PAG. 78

800

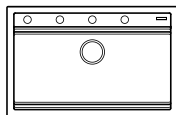

BEST 130
PAG. 79

800

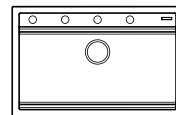

BEST 130 BUNDLE
PAG. 79



DISEGNI TECNICI
APPROFONDITI
LINEA BEST
WORKSTATION

Corredo del lavello: Sifone salvaspazio, piletta Flow Pro integrata, troppopieno rettangolare e ganci.

Corredo del lavello Bundle: Colander, Drainer Flex, sifone salvaspazio, piletta Flow Pro integrata, troppopieno integrato e ganci.

KERATEK^{Plus}
CERAMIC NANOTECHNOLOGY CN6



K99 Dark Grey



K97 Light Grey

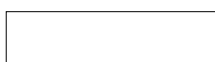

K96 White



K95 Champagne



K93 Dove Grey



K86 Black

GRANITEK[®]
NATURAL GRANITE EFFECT

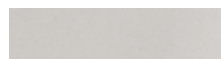

M79 Aluminium



M78 Espresso



M73 Titanium

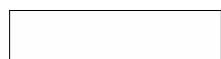

G68 Bianco



G48 Cemento

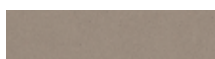

G43 Tortora



G40 Nero



G62 Bianco Antico



G59 Antracite



G51 Avena



**ACCESSORI
ELEMENT**

La serie più completa di accessori per esaltare l'ergonomia in cucina. Dal drainer flex al colander, dal tagliere al pop up control, al dispenser sapone: tutto ciò che serve per vivere una vera Workstation.



VASCA XL

Vasca dallo spazio ampio e maggiorato per ospitare utensili di grandi dimensioni e facilitare le operazioni di utilizzo.



**PILETTA FLOW PRO INTEGRATA
E TROPPOPIENO
RETTANGOLARE INTEGRATO**

Due elementi di stile ed eleganza già inclusi nel corredo del lavello. La piletta Flow Pro integrata e il troppopieno rettangolare incorporano design e funzionalità.

BEST 360

Lavello 1 vasca

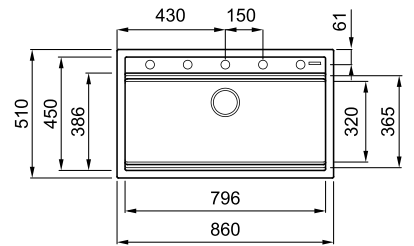

Disegno Tecnico approfondito: QR code a pag. 77



CARATTERISTICHE

Dimensioni (mm)	860 x 510
Base (mm)	900
Foro da incasso (mm)	840 x 480
Profondità Vasca (mm)	200
Orientamento	Non reversibile

ACCESSORI CONSIGLIATI

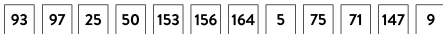

MATERIALI E COLORI

KERATEK plus CERAMIC NANOTECHNOLOGY CNS Euro **673**

- K99 Dark Grey LKB36099
- K97 Light Grey LKB36097
- K96 White LKB36096
- K95 Champagne LKB36095
- K93 Dove Grey LKB36093
- K86 Black LKB36086

GRANITEK NATURAL GRANITE EFFECT Euro **524**

- METAL
- M79 Aluminium LMB36079
 - M78 Espresso LMB36078
 - M73 Titanium LMB36073

GRANITEK NATURAL GRANITE EFFECT Euro **502**

- MATT
- G68 Bianco LGB36068
 - G48 Cemento LGB36048
 - G43 Tortora LGB36043
 - G40 Nero LGB36040

- CLASSIC
- G62 Bianco Antico LGB36062
 - G59 Antracite LGB36059
 - G51 Avena LGB36051

BEST 360 BUNDLE

Lavello 1 vasca con colander e drainer flex inclusi



NEW

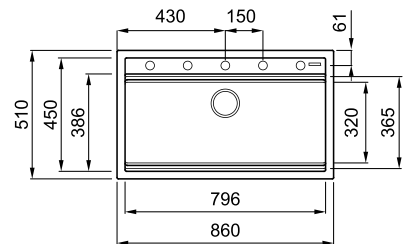

Disegno Tecnico approfondito: QR code a pag. 77



CARATTERISTICHE

Dimensioni (mm)	860 x 510
Base (mm)	900
Foro da incasso (mm)	840 x 480
Profondità Vasca (mm)	200
Orientamento	Non reversibile

Colander e drainer flex inclusi

ACCESSORI CONSIGLIATI

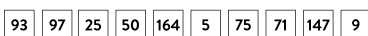

MATERIALI E COLORI

KERATEK plus CERAMIC NANOTECHNOLOGY CNS Euro **803**

- K99 Dark Grey LKB36099K2
- K97 Light Grey LKB36097K2
- K96 White LKB36096K2
- K95 Champagne LKB36095K2
- K93 Dove Grey LKB36093K2
- K86 Black LKB36086K2

GRANITEK NATURAL GRANITE EFFECT Euro **655**

- METAL
- M79 Aluminium LMB36079K2
 - M78 Espresso LMB36078K2
 - M73 Titanium LMB36073K2

GRANITEK NATURAL GRANITE EFFECT Euro **631**

- MATT
- G68 Bianco LGB36068K2
 - G48 Cemento LGB36048K2
 - G43 Tortora LGB36043K2
 - G40 Nero LGB36040K2

- CLASSIC
- G62 Bianco Antico LGB36062K2
 - G59 Antracite LGB36059K2
 - G51 Avena LGB36051K2

93 Element Tagliere Best Workstation



ATH073QU
Euro **127**
Pag. 169

156 Element Drainer Flex 500

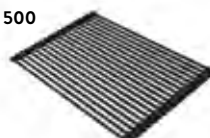

ARS023BK
Euro **88**
Pag. 173

153 Element Colander Best Workstation



AVP034BK
Euro **64**
Pag. 173

BEST 130



NEW

Lavello 1 vasca

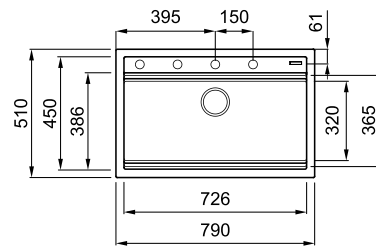

Disegno Tecnico approfondito: QR code a pag. 77



MATERIALI E COLORI

KERATEK plus
CERAMIC NANOTECHNOLOGY CNG

- K99 Dark Grey LKB13099
- K97 Light Grey LKB13097
- K96 White LKB13096
- K95 Champagne LKB13095
- K93 Dove Grey LKB13093
- K86 Black LKB13086

GRANITEK
NATURAL GRANITE EFFECT

METAL

- M79 Aluminium LMB13079
- M78 Espresso LMB13078
- M73 Titanium LMB13073

GRANITEK
NATURAL GRANITE EFFECT

MATT

- G68 Bianco LGB13068
- G48 Cemento LGB13048
- G43 Tortora LGB13043
- G40 Nero LGB13040

CLASSIC

- G62 Bianco Antico LGB13062
- G59 Antracite LGB13059
- G51 Avena LGB13051

CARATTERISTICHE

- Dimensioni (mm) **790 x 510**
- Base (mm) **800**
- Foro da incasso (mm) **770 x 480**
- Profondità Vasca (mm) **200**
- Orientamento **Non reversibile**

ACCESSORI CONSIGLIATI

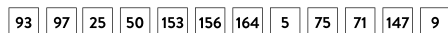

BEST 130 BUNDLE



NEW

Lavello 1 vasca con colander e drainer flex inclusi

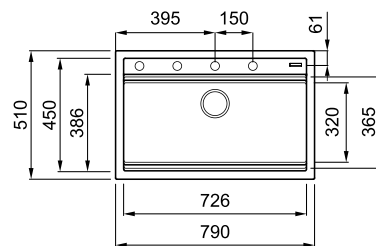

Disegno Tecnico approfondito: QR code a pag. 77



MATERIALI E COLORI

KERATEK plus
CERAMIC NANOTECHNOLOGY CNG

- K99 Dark Grey LKB13099K2
- K97 Light Grey LKB13097K2
- K96 White LKB13096K2
- K95 Champagne LKB13095K2
- K93 Dove Grey LKB13093K2
- K86 Black LKB13086K2

GRANITEK
NATURAL GRANITE EFFECT

METAL

- M79 Aluminium LMB13079K2
- M78 Espresso LMB13078K2
- M73 Titanium LMB13073K2

GRANITEK
NATURAL GRANITE EFFECT

MATT

- G68 Bianco LGB13068K2
- G48 Cemento LGB13048K2
- G43 Tortora LGB13043K2
- G40 Nero LGB13040K2

CLASSIC

- G62 Bianco Antico LGB13062K2
- G59 Antracite LGB13059K2
- G51 Avena LGB13051K2

CARATTERISTICHE

- Dimensioni (mm) **790 x 510**
- Base (mm) **800**
- Foro da incasso (mm) **770 x 480**
- Profondità Vasca (mm) **200**
- Orientamento **Non reversibile**

Colander e drainer flex inclusi

ACCESSORI CONSIGLIATI

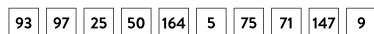

25 Element Dispenser
Sapone Tondo



ADI02300
Euro **42**
Pag. 172

97 Element Pop-Up
Push Control



ASP13002BK
Euro **96**
Pag. 171

160 Spray Detergente
Sgrassante Daily Clean



DLL01601
Pag. 175

COLLEZIONE

BEST

L'EFFICIENZA DELLE
GEOMETRIE RAZIONALI





COLLEZIONE

BEST

Best è la collezione di lavelli in composito dall'estetica razionale che permette il massimo dell'efficienza grazie al bordo salva goccia professional e allo scorrimento degli accessori lungo tutto il lavello. I lavelli Best dispongono di spartivasche maggiorato con area miscelatori integrata, per un utilizzo più completo.



SOPRATOP



SOTTOTOP

Solo Best 450



Lavello Best 480 G48 Cemento con miscelatore Stream Plus G48 Cemento

800

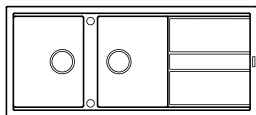

BEST 500
PAG. 84

600

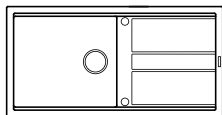

BEST 480
PAG. 84

600

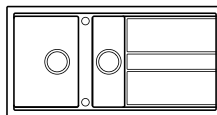

BEST 475
PAG. 85

900

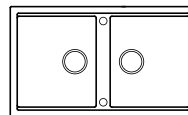

BEST 450
PAG. 85

900

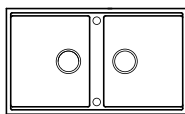

BEST 450
SOTTOTOP
PAG. 86

450

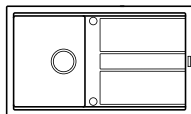

BEST 400
PAG. 86



DISEGNI TECNICI
APPROFONDITI
LINEA BEST

Corredo del lavello: Sifone salvaspazio, piletta Flow Pro integrata, troppopieno rettangolare e ganci.

KERATEK^{Plus}
CERAMIC NANOTECHNOLOGY CN6



K99 Dark Grey



K97 Light Grey



K96 White

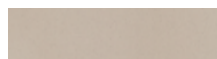

K95 Champagne

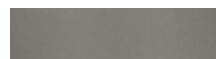

K93 Dove Grey



K86 Black

GRANITEK[®]
NATURAL GRANITE EFFECT



M79 Aluminium



M78 Espresso



M73 Titanium



G68 Bianco



G48 Cemento

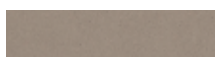

G43 Tortora



G40 Nero



G62 Bianco Antico



G59 Antracite



G51 Avena



SPARTIVASCHE
MAGGIORATO

Il miscelatore trova la sua ideale collocazione posizionandosi sullo spartivasche con superficie maggiorata, per un utilizzo sempre più ergonomico.



BORDO
SALVAGOCCIA

Lo speciale bordo salvagoccia permette agli accessori di scorrere lungo il perimetro e al contempo limita le fuoriuscite accidentali d'acqua.



PILETTA FLOW PRO INTEGRATA
E TROPPOPIENO
RETTANGOLARE INTEGRATO

Due elementi di stile ed eleganza già inclusi nel corredo del lavello. La piletta Flow Pro integrata e il troppopieno rettangolare incorporano design e funzionalità.



ACCESSORI ELEMENT

Il tagliere e il drainer flex permettono di completare il lavello a proprio gusto e piacimento, rendendo le operazioni di preparazione del cibo più facili e pratiche.

BEST 500



CARATTERISTICHE

Dimensioni (mm)	1160 x 510
Base (mm)	800
Foro da incasso (mm)	1140 x 480
Profondità Vasca 1 (mm)	200
Profondità Vasca 2 (mm)	200
Orientamento	Reversibile

ACCESSORI CONSIGLIATI

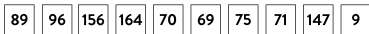

Lavello 2 vasche con gocciolatoio

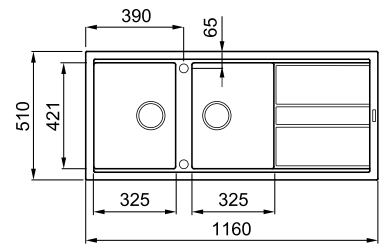

Disegno Tecnico approfondito: QR code a pag. 83

MATERIALI E COLORI

KERATEK plus CERAMIC NANOTECHNOLOGY CN8 Euro **695**

● K99 Dark Grey	LKB50099
● K97 Light Grey	LKB50097
○ K96 White	LKB50096
● K95 Champagne	LKB50095
● K93 Dove Grey	LKB50093
● K86 Black	LKB50086

GRANITEK NATURAL GRANITE EFFECT Euro **544**

METAL	
● M79 Aluminium	LMB50079
● M78 Espresso	LMB50078
● M73 Titanium	LMB50073

GRANITEK NATURAL GRANITE EFFECT Euro **516**

MATT

○ G68 Bianco	LGB50068
● G48 Cemento	LGB50048
● G43 Tortora	LGB50043
● G40 Nero	LGB50040

CLASSIC

● G62 Bianco Antico	LGB50062
● G59 Antracite	LGB50059
● G51 Avena	LGB50051

BEST 480

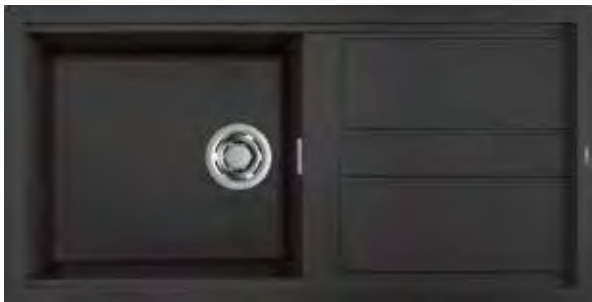

CARATTERISTICHE

Dimensioni (mm)	1000 x 510
Base (mm)	600
Foro da incasso (mm)	980 x 480
Profondità Vasca (mm)	200
Orientamento	Reversibile

ACCESSORI CONSIGLIATI



Lavello 1 vasca con gocciolatoio

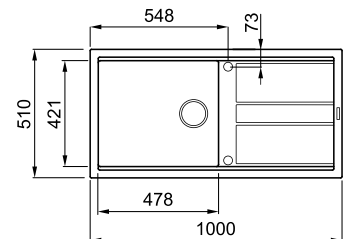

Disegno Tecnico approfondito: QR code a pag. 83

MATERIALI E COLORI

KERATEK plus CERAMIC NANOTECHNOLOGY CN8 Euro **673**

● K99 Dark Grey	LKB48099
● K97 Light Grey	LKB48097
○ K96 White	LKB48096
● K95 Champagne	LKB48095
● K93 Dove Grey	LKB48093
● K86 Black	LKB48086

GRANITEK NATURAL GRANITE EFFECT Euro **524**

METAL	
● M79 Aluminium	LMB48079
● M78 Espresso	LMB48078
● M73 Titanium	LMB48073

GRANITEK NATURAL GRANITE EFFECT Euro **502**

MATT

○ G68 Bianco	LGB48068
● G48 Cemento	LGB48048
● G43 Tortora	LGB48043
● G40 Nero	LGB48040

CLASSIC

● G62 Bianco Antico	LGB48062
● G59 Antracite	LGB48059
● G51 Avena	LGB48051

89 Element Tagliere Best Line



ATH0200L
Euro **123**
Pag. 168

156 Element Drainer Flex 500

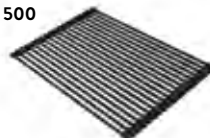

ARS023BK
Euro **88**
Pag. 173

70 Colander Best



AVI03000
Euro **110**
Pag. 178

BEST 475

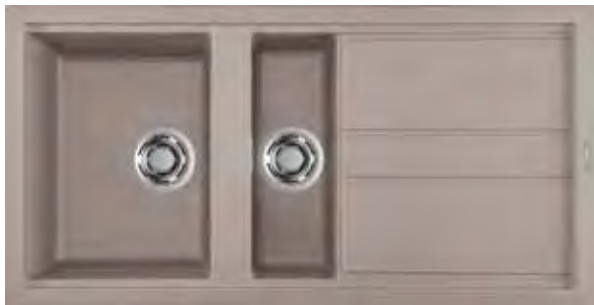

CARATTERISTICHE

Dimensioni (mm)	1000 x 510
Base (mm)	600
Foro da incasso (mm)	980 x 480
Profondità Vasca 1 (mm)	200
Profondità Vasca 2 (mm)	140
Orientamento	Reversibile

ACCESSORI CONSIGLIATI

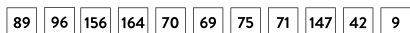

Lavello 1 vasca ½ con gocciolatoio

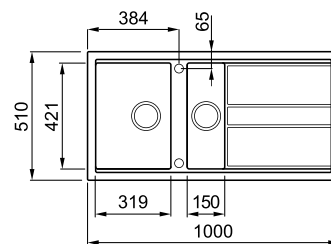

Disegno Tecnico approfondito: QR code a pag. 83

MATERIALI E COLORI

KERATEK plus
CERAMIC NANOTECHNOLOGY CNG

Euro 681	
● K99 Dark Grey	LKB47599
● K97 Light Grey	LKB47597
○ K96 White	LKB47596
● K95 Champagne	LKB47595
● K93 Dove Grey	LKB47593
● K86 Black	LKB47586

GRANITEK
NATURAL GRANITE EFFECT

Euro 530	
METAL	
● M79 Aluminium	LMB47579
● M78 Espresso	LMB47578
● M73 Titanium	LMB47573

GRANITEK
NATURAL GRANITE EFFECT

Euro 505	
MATT	
○ G68 Bianco	LGB47568
● G48 Cemento	LGB47548
● G43 Tortora	LGB47543
● G40 Nero	LGB47540
CLASSIC	
● G62 Bianco Antico	LGB47562
● G59 Antracite	LGB47559
● G51 Avena	LGB47551

BEST 450



CARATTERISTICHE

Dimensioni (mm)	860 x 510
Base (mm)	900
Foro da incasso (mm)	840 x 480
Profondità Vasca 1 (mm)	200
Profondità Vasca 2 (mm)	200
Orientamento	Reversibile

ACCESSORI CONSIGLIATI

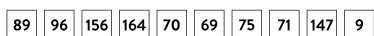

Lavello 2 vasche

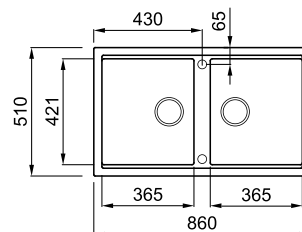

Disegno Tecnico approfondito: QR code a pag. 83

MATERIALI E COLORI

KERATEK plus
CERAMIC NANOTECHNOLOGY CNG

Euro 620	
● K99 Dark Grey	LKB45099
● K97 Light Grey	LKB45097
○ K96 White	LKB45096
● K95 Champagne	LKB45095
● K93 Dove Grey	LKB45093
● K86 Black	LKB45086

GRANITEK
NATURAL GRANITE EFFECT

Euro 483	
METAL	
● M79 Aluminium	LMB45079
● M78 Espresso	LMB45078
● M73 Titanium	LMB45073

GRANITEK
NATURAL GRANITE EFFECT

Euro 461	
MATT	
○ G68 Bianco	LGB45068
● G48 Cemento	LGB45048
● G43 Tortora	LGB45043
● G40 Nero	LGB45040
CLASSIC	
● G62 Bianco Antico	LGB45062
● G59 Antracite	LGB45059
● G51 Avena	LGB45051

96 Element Pop-Up
Push Control 2 vie



ASP23002
Euro **71**
Pag. 171

150 Crema Smacchiante Deep
Clean Lavelli Keratek



DLC01602
Pag. 175

151 Crema Smacchiante Deep
Clean Lavelli Granitek



DLC01601
Pag. 175

BEST 450 SOTTOTOP

Lavello 2 vasche

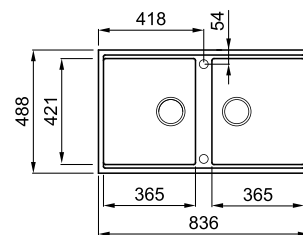
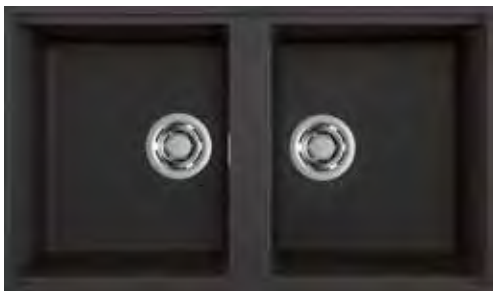

Disegno Tecnico approfondito: QR code a pag. 83



CARATTERISTICHE

Dimensioni (mm)	836 x 488
Base (mm)	900
Foro da incasso (mm)	795 x 448 R6
Profondità Vasca 1 (mm)	200
Profondità Vasca 2 (mm)	200
Orientamento	Reversibile

ACCESSORI CONSIGLIATI

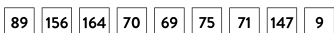

MATERIALI E COLORI

KERATEK CERAMIC NANOTECHNOLOGY CN8	Euro 651
● K99 Dark Grey	LKB45099BSO
● K97 Light Grey	LKB45097BSO
○ K96 White	LKB45096BSO
● K95 Champagne	LKB45095BSO
● K93 Dove Grey	LKB45093BSO
● K86 Black	LKB45086BSO
GRANITEK NATURAL GRANITE EFFECT	Euro 508
METAL	
● M79 Aluminium	LMB45079BSO
● M78 Espresso	LMB45078BSO
● M73 Titanium	LMB45073BSO

GRANITEK NATURAL GRANITE EFFECT	Euro 485
MATT	
○ G68 Bianco	LGB45068BSO
● G48 Cemento	LGB45048BSO
● G43 Tortora	LGB45043BSO
● G40 Nero	LGB45040BSO
CLASSIC	
● G62 Bianco Antico	LGB45062BSO
● G59 Antracite	LGB45059BSO
● G51 Avena	LGB45051BSO

BEST 400

Lavello 1 vasca con gocciolatoio

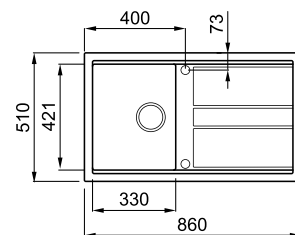
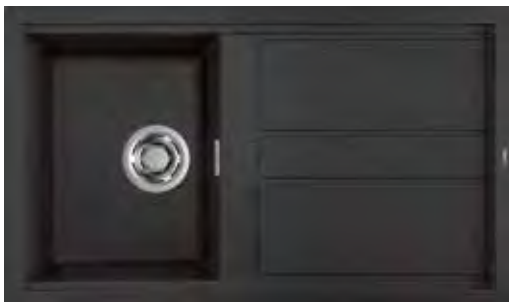

Disegno Tecnico approfondito: QR code a pag. 83



CARATTERISTICHE

Dimensioni (mm)	860 x 510
Base (mm)	450
Foro da incasso (mm)	840 x 480
Profondità Vasca (mm)	200
Orientamento	Reversibile

ACCESSORI CONSIGLIATI

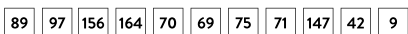

MATERIALI E COLORI

KERATEK CERAMIC NANOTECHNOLOGY CN8	Euro 591
● K99 Dark Grey	LKB40099
● K97 Light Grey	LKB40097
○ K96 White	LKB40096
● K95 Champagne	LKB40095
● K93 Dove Grey	LKB40093
● K86 Black	LKB40086
GRANITEK NATURAL GRANITE EFFECT	Euro 458
METAL	
● M79 Aluminium	LMB40079
● M78 Espresso	LMB40078
● M73 Titanium	LMB40073

GRANITEK NATURAL GRANITE EFFECT	Euro 438
MATT	
○ G68 Bianco	LGB40068
● G48 Cemento	LGB40048
● G43 Tortora	LGB40043
● G40 Nero	LGB40040
CLASSIC	
● G62 Bianco Antico	LGB40062
● G59 Antracite	LGB40059
● G51 Avena	LGB40051

89 Element Tagliere Best Line



ATH020GR
Euro **123**
Pag. 168

156 Element Drainer Flex 500

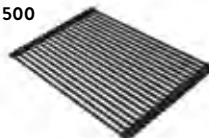

ARS023BK
Euro **88**
Pag. 173

71 Bottom Grid S



AGB01306
Euro **78**
Pag. 179



164 Element Kit Piletta e Troppopieno Black



COMPP90CTPLUXABK

Euro **74**

Pag. 174

160 Spray Detergente Sgrassante Daily Clean



DLL01601

Pag. 175

162 Panni in Microfibra Fast Clean



DKP01001

Pag. 177



COLLEZIONE

QUADRA

SOPRATOP

DESIGN MINIMALE E DALLO
STILE CONTEMPORANEO



COLLEZIONE

QUADRA

Una collezione minimale che grazie alla sua semplicità riesce a mettere in risalto le linee moderne e pulite che la caratterizzano. Ogni modello è combinabile con numerosi accessori e molteplici colorazioni.



SOPRATOP



Lavello Quadra 105 G43 Tortora con miscelatore Trail G43 Tortora

800

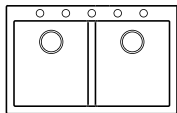
**QUADRA 350**
PAG. 92

600

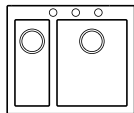
**QUADRA 150**
PAG. 92

800

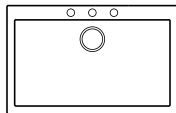
**QUADRA 130**
PAG. 93

600

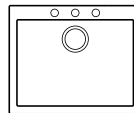
**QUADRA 110**
PAG. 93

600

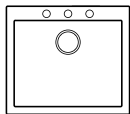
**QUADRA 105**
PAG. 94

450

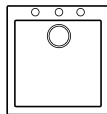

NEW

QUADRA 102
PAG. 94

450

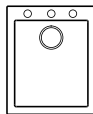
**QUADRA 100**
PAG. 95

300

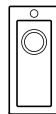
**QUADRA 50**
PAG. 95

800

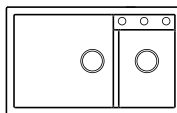
**QUADRA 440**
PAG. 96

800

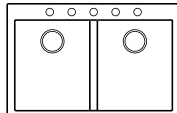
**QUADRA 340**
PAG. 96

900

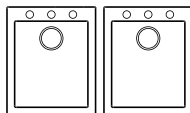
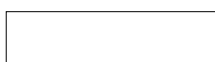
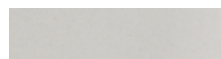
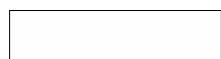
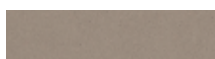
**QUADRA 200**
PAG. 97DISEGNI TECNICI
APPROFONDITI
LINEA QUADRA**Corredo del lavello:** Sifone salvaspazio, pilette e ganci.**KERATEK** Plus
CERAMIC NANOTECHNOLOGY CN6**K99** Dark Grey**K97** Light Grey**K96** White**K95** Champagne**K93** Dove Grey**K86** Black**GRANITEK**
NATURAL GRANITE EFFECT**M79** Aluminium**M78** Espresso**M73** Titanium**M70** Ghisa**G68** Bianco**G48** Cemento**G43** Tortora**G40** Nero**G62** Bianco Antico**G59** Antracite**G54** Nero Pietra**G52** Bianco Pietra**G51** Avena**ESTETICA**

Lo stile razionale, minimal e pratico di Quadra permette un suo facile inserimento estetico in ogni ambiente cucina, qualunque sia la sua dimensione e il suo stile.

**ACCESSORI ELEMENT**

La serie più completa di accessori per esaltare l'ergonomia in cucina. Dal drainer flex al colander, dal tagliere al pop up control, al dispenser sapone: tutto è a portata di Quadra.

**AREA ACCESSORI INTEGRATA**

Area dotata di prefori che permette di installare una molteplicità di accessori: piletta salterello, miscelatore, dispenser del sapone ad ingombro ridotto.

**ACCESSORIO ELEMENT COVER MATERICA**

Quel tocco di classe in più. La cover piletta materica è realizzata negli stessi materiali e colori del lavello, esaltando gli accordi estetici tra gli elementi e valorizzando l'ambiente circostante.

QUADRA 350



Lavello 2 vasche

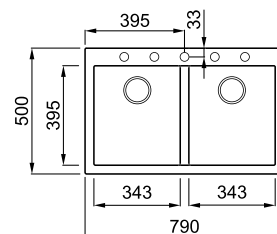

Disegno Tecnico approfondito: QR code a pag. 91



CARATTERISTICHE

Dimensioni (mm)	790 x 500
Base (mm)	800
Foro da incasso (mm)	770 x 480
Profondità Vasca 1 (mm)	210
Profondità Vasca 2 (mm)	210
Orientamento	Non reversibile

ACCESSORI CONSIGLIATI

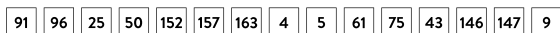

MATERIALI E COLORI

KERATEK CERAMIC NANOTECHNOLOGY CN8 Euro **567**

- K99 Dark Grey LKQ35099
- K97 Light Grey LKQ35097
- K96 White LKQ35096
- K95 Champagne LKQ35095
- K93 Dove Grey LKQ35093
- K86 Black LKQ35086

GRANITEK NATURAL GRANITE EFFECT Euro **460**

- METAL
- M79 Aluminium LMQ35079
 - M78 Espresso LMQ35078
 - M73 Titanium LMQ35073
 - M70 Ghisa LMQ35070

GRANITEK NATURAL GRANITE EFFECT Euro **435**

- MATT
- G68 Bianco LGQ35068
 - G48 Cemento LGQ35048
 - G43 Tortora LGQ35043
 - G40 Nero LGQ35040

- CLASSIC
- G62 Bianco Antico LGQ35062
 - G59 Antracite LGQ35059
 - G54 Nero Pietra LGQ35054
 - G52 Bianco Pietra LGQ35052
 - G51 Avena LGQ35051

QUADRA 150

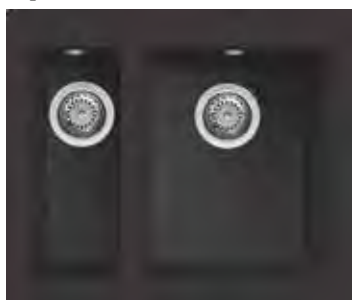

Lavello 2 vasche

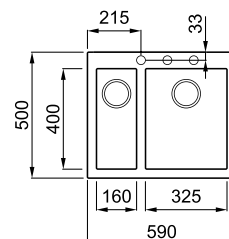

Disegno Tecnico approfondito: QR code a pag. 91



CARATTERISTICHE

Dimensioni (mm)	590 x 500
Base (mm)	600
Foro da incasso (mm)	da disegno
Profondità Vasca 1 (mm)	200
Profondità Vasca 2 (mm)	155
Orientamento	Non reversibile

ACCESSORI CONSIGLIATI

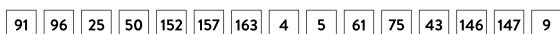

MATERIALI E COLORI

KERATEK CERAMIC NANOTECHNOLOGY CN8 Euro **496**

- K99 Dark Grey LKQ15099
- K97 Light Grey LKQ15097
- K96 White LKQ15096
- K95 Champagne LKQ15095
- K93 Dove Grey LKQ15093
- K86 Black LKQ15086

GRANITEK NATURAL GRANITE EFFECT Euro **402**

- METAL
- M79 Aluminium LMQ15079
 - M78 Espresso LMQ15078
 - M73 Titanium LMQ15073
 - M70 Ghisa LMQ15070

GRANITEK NATURAL GRANITE EFFECT Euro **378**

- MATT
- G68 Bianco LGQ15068
 - G48 Cemento LGQ15048
 - G43 Tortora LGQ15043
 - G40 Nero LGQ15040

- CLASSIC
- G62 Bianco Antico LGQ15062
 - G59 Antracite LGQ15059
 - G54 Nero Pietra LGQ15054
 - G52 Bianco Pietra LGQ15052
 - G51 Avena LGQ15051

91 Element Tagliere 420



ATH040GR
Euro **1123**
Pag. 169

157 Element Drainer Flex 440

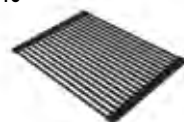

ARS013BK
Euro **80**
Pag. 174

152 Element Colander 418



AVP035BK
Euro **64**
Pag. 173

QUADRA 130



Lavello 1 vasca

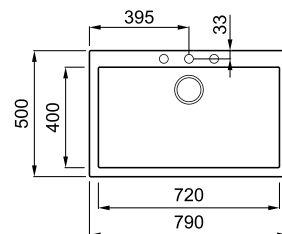

CARATTERISTICHE

Dimensioni (mm)	790 x 500
Base (mm)	800
Foro da incasso (mm)	770 x 480
Profondità Vasca (mm)	200
Orientamento	Non reversibile

ACCESSORI CONSIGLIATI



MATERIALI E COLORI

KERATEK plus
CERAMIC NANOTECHNOLOGY CNG

Euro 496	
● K99 Dark Grey	LKQ13099
● K97 Light Grey	LKQ13097
○ K96 White	LKQ13096
● K95 Champagne	LKQ13095
● K93 Dove Grey	LKQ13093
● K86 Black	LKQ13086

GRANITEK
NATURAL GRANITE EFFECT

Euro 402	
METAL	
● M79 Aluminium	LMQ13079
● M78 Espresso	LMQ13078
● M73 Titanium	LMQ13073
● M70 Ghisa	LMQ13070

GRANITEK
NATURAL GRANITE EFFECT

Euro 378	
MATT	
○ G68 Bianco	LGQ13068
● G48 Cemento	LGQ13048
● G43 Tortora	LGQ13043
● G40 Nero	LGQ13040
CLASSIC	
● G62 Bianco Antico	LGQ13062
● G59 Antracite	LGQ13059
● G54 Nero Pietra	LGQ13054
● G52 Bianco Pietra	LGQ13052
● G51 Avena	LGQ13051

Disegno Tecnico approfondito: QR code a pag. 91

QUADRA 110



Lavello 1 vasca

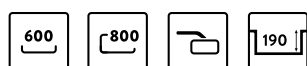
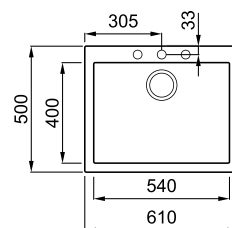

CARATTERISTICHE

Dimensioni (mm)	610 x 500
Base (mm)	600
- se inizio composizione	800
Foro da incasso (mm)	590 x 480
Profondità Vasca (mm)	190
Orientamento	Non reversibile

ACCESSORI CONSIGLIATI

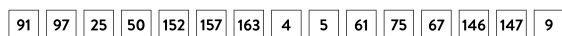

MATERIALI E COLORI

KERATEK plus
CERAMIC NANOTECHNOLOGY CNG

Euro 450	
● K99 Dark Grey	LKQ11099
● K97 Light Grey	LKQ11097
○ K96 White	LKQ11096
● K95 Champagne	LKQ11095
● K93 Dove Grey	LKQ11093
● K86 Black	LKQ11086

GRANITEK
NATURAL GRANITE EFFECT

Euro 366	
METAL	
● M79 Aluminium	LMQ11079
● M78 Espresso	LMQ11078
● M73 Titanium	LMQ11073
● M70 Ghisa	LMQ11070

GRANITEK
NATURAL GRANITE EFFECT

Euro 343	
MATT	
○ G68 Bianco	LGQ11068
● G48 Cemento	LGQ11048
● G43 Tortora	LGQ11043
● G40 Nero	LGQ11040
CLASSIC	
● G62 Bianco Antico	LGQ11062
● G59 Antracite	LGQ11059
● G54 Nero Pietra	LGQ11054
● G52 Bianco Pietra	LGQ11052
● G51 Avena	LGQ11051

Disegno Tecnico approfondito: QR code a pag. 91

163 Element Cover
Piletta Materica



AGCP1268
Euro **42**
Pag. 174

25 Element Dispenser
Sapone Tondo



ADI02300BK
Euro **64**
Pag. 172

150 Crema Smacchiante Deep
Clean Lavelli Keratek



DLC01602
Pag. 175

QUADRA 105

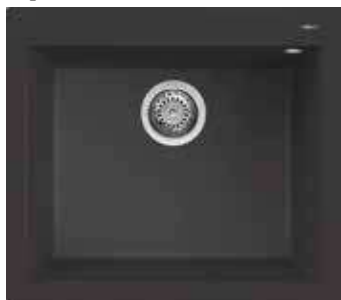

Lavello 1 vasca

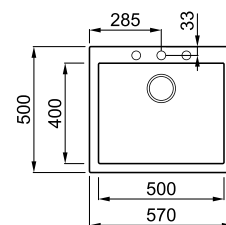

Disegno Tecnico approfondito: QR code a pag. 91



CARATTERISTICHE

Dimensioni (mm)	570 x 500
Base (mm)	600
Foro da incasso (mm)	550 x 480
Profondità Vasca (mm)	200
Orientamento	Non reversibile

ACCESSORI CONSIGLIATI



MATERIALI E COLORI

KERATEK CERAMIC NANOTECHNOLOGY CN8 Euro **450**

● K99 Dark Grey	LKQ10599
● K97 Light Grey	LKQ10597
○ K96 White	LKQ10596
● K95 Champagne	LKQ10595
● K93 Dove Grey	LKQ10593
● K86 Black	LKQ10586

GRANITEK NATURAL GRANITE EFFECT Euro **366**

METAL	
● M79 Aluminium	LMQ10579
● M78 Espresso	LMQ10578
● M73 Titanium	LMQ10573
● M70 Ghisa	LMQ10570

GRANITEK NATURAL GRANITE EFFECT Euro **343**

MATT	
○ G68 Bianco	LGQ10568
● G48 Cemento	LGQ10548
● G43 Tortora	LGQ10543
● G40 Nero	LGQ10540

CLASSIC	
● G62 Bianco Antico	LGQ10562
● G59 Antracite	LGQ10559
● G54 Nero Pietra	LGQ10554
● G52 Bianco Pietra	LGQ10552
● G51 Avena	LGQ10551

QUADRA 102



NEW

Lavello 1 vasca

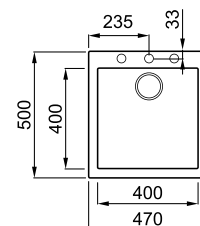

Disegno Tecnico approfondito: QR code a pag. 91



CARATTERISTICHE

Dimensioni (mm)	470 x 500
Base (mm)	450
- se inizio composizione	500
Foro da incasso (mm)	450 x 480
Profondità Vasca (mm)	200
Orientamento	Non reversibile

ACCESSORI CONSIGLIATI



MATERIALI E COLORI

KERATEK CERAMIC NANOTECHNOLOGY CN8 Euro **450**

● K99 Dark Grey	LKQ10299
● K97 Light Grey	LKQ10297
○ K96 White	LKQ10296
● K95 Champagne	LKQ10295
● K93 Dove Grey	LKQ10293
● K86 Black	LKQ10286

GRANITEK NATURAL GRANITE EFFECT Euro **366**

METAL	
● M79 Aluminium	LMQ10279
● M78 Espresso	LMQ10278
● M73 Titanium	LMQ10273
● M70 Ghisa	LMQ10270

GRANITEK NATURAL GRANITE EFFECT Euro **343**

MATT	
○ G68 Bianco	LGQ10268
● G48 Cemento	LGQ10248
● G43 Tortora	LGQ10243
● G40 Nero	LGQ10240

CLASSIC	
● G62 Bianco Antico	LGQ10262
● G59 Antracite	LGQ10259
● G54 Nero Pietra	LGQ10254
● G52 Bianco Pietra	LGQ10252
● G51 Avena	LGQ10251

91 Element Tagliere 420



ATH040QU
Euro **123**
Pag. 169

Escluso Quadra 50

50 Element Dispenser Sapone Quadrato



ADI02301
Euro **102**
Pag. 172

Escluso Quadra 50

152 Element Colander 418



AVP035BK
Euro **64**
Pag. 173

Escluso Quadra 50

QUADRA 100



Lavello 1 vasca

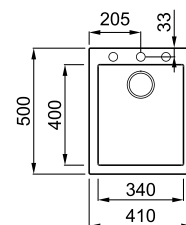

CARATTERISTICHE

Dimensioni (mm)	410 x 500
Base (mm)	450
Foro da incasso (mm)	390 x 480
Profondità Vasca (mm)	190
Orientamento	Non reversibile

ACCESSORI CONSIGLIATI

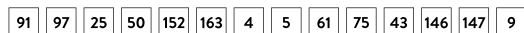

MATERIALI E COLORI

KERATEK plus
CERAMIC NANOTECHNOLOGY CNG

Euro	357
● K99 Dark Grey	LKQ10099
● K97 Light Grey	LKQ10097
○ K96 White	LKQ10096
● K95 Champagne	LKQ10095
● K93 Dove Grey	LKQ10093
● K86 Black	LKQ10086

GRANITEK
NATURAL GRANITE EFFECT

Euro	285
METAL	
● M79 Aluminium	LMQ10079
● M78 Espresso	LMQ10078
● M73 Titanium	LMQ10073
● M70 Ghisa	LMQ10070

GRANITEK
NATURAL GRANITE EFFECT

Euro	271
MATT	
○ G68 Bianco	LGQ10068
● G48 Cemento	LGQ10048
● G43 Tortora	LGQ10043
● G40 Nero	LGQ10040
CLASSIC	
● G62 Bianco Antico	LGQ10062
● G59 Antracite	LGQ10059
● G54 Nero Pietra	LGQ10054
● G52 Bianco Pietra	LGQ10052
● G51 Avena	LGQ10051

Disegno Tecnico approfondito: QR code a pag. 91

QUADRA 50



Lavello 1 vasca

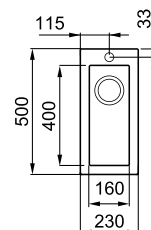

CARATTERISTICHE

Dimensioni (mm)	230 x 500
Base (mm)	300
Foro da incasso (mm)	da disegno
Profondità Vasca (mm)	155
Orientamento	Non reversibile

ACCESSORI CONSIGLIATI



MATERIALI E COLORI

KERATEK plus
CERAMIC NANOTECHNOLOGY CNG

Euro	295
● K99 Dark Grey	LKQ05099
● K97 Light Grey	LKQ05097
○ K96 White	LKQ05096
● K95 Champagne	LKQ05095
● K93 Dove Grey	LKQ05093
● K86 Black	LKQ05086

GRANITEK
NATURAL GRANITE EFFECT

Euro	236
METAL	
● M79 Aluminium	LMQ05079
● M78 Espresso	LMQ05078
● M73 Titanium	LMQ05073
● M70 Ghisa	LMQ05070

GRANITEK
NATURAL GRANITE EFFECT

Euro	225
MATT	
○ G68 Bianco	LGQ05068
● G48 Cemento	LGQ05048
● G43 Tortora	LGQ05043
● G40 Nero	LGQ05040
CLASSIC	
● G62 Bianco Antico	LGQ05062
● G59 Antracite	LGQ05059
● G54 Nero Pietra	LGQ05054
● G52 Bianco Pietra	LGQ05052
● G51 Avena	LGQ05051

Disegno Tecnico approfondito: QR code a pag. 91

163 Element Cover
Piletta Materica



AKCP1286
Euro **42**
Pag. 174

Bottom Grid

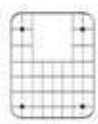

Euro
AGB01304 **88** 67
AGB01300 **71** 43
Pag. 179

67 43
Q105 Q102/100

151 Crema Smacchiante Deep
Clean Lavelli Granitek



DLC01601
Pag. 175

QUADRA 440

Lavello 2 vasche

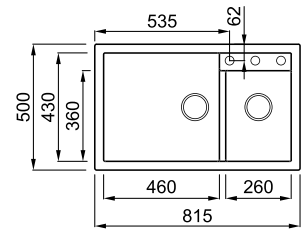

Disegno Tecnico approfondito: QR code a pag. 91

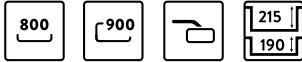

CARATTERISTICHE

Dimensioni (mm)	815 x 500
Base (mm)	800
- se inizio composizione	900
Foro da incasso (mm)	800 x 480
Profondità Vasca 1 (mm)	215
Profondità Vasca 2 (mm)	190
Orientamento	Non reversibile

ACCESSORI CONSIGLIATI



MATERIALI E COLORI

GRANITEK NATURAL GRANITE EFFECT	Euro 531
METAL	
● M79 Aluminium	LMQ44079
● M73 Titanium	LMQ44073

GRANITEK NATURAL GRANITE EFFECT	Euro 502
MATT	
○ G68 Bianco	LGQ44068
● G43 Tortora	LGQ44043
● G40 Nero	LGQ44040
CLASSIC	
● G51 Avena	LGQ44051

QUADRA 340

Lavello 2 vasche

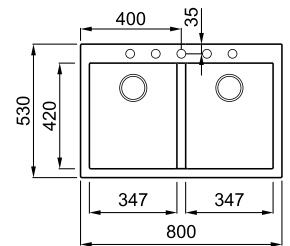

Disegno Tecnico approfondito: QR code a pag. 91



CARATTERISTICHE

Dimensioni (mm)	800 x 530
Base (mm)	800
- se inizio composizione	900
Foro da incasso (mm)	780 x 510
Profondità Vasca 1 (mm)	215
Profondità Vasca 2 (mm)	215
Orientamento	Non reversibile

ACCESSORI CONSIGLIATI

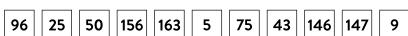

MATERIALI E COLORI

GRANITEK NATURAL GRANITE EFFECT	Euro 506
METAL	
● M79 Aluminium	LMQ34079BTP
● M73 Titanium	LMQ34073BTP

GRANITEK NATURAL GRANITE EFFECT	Euro 478
MATT	
○ G68 Bianco	LGQ34068BTP
● G43 Tortora	LGQ34043BTP
● G40 Nero	LGQ34040BTP
CLASSIC	
● G51 Avena	LGQ34051BTP

91 Element
Tagliere 420



ATH040OL
Euro **123**
Pag. 169

Solo Quadra 200

156 Element Drainer Flex
500 - 440

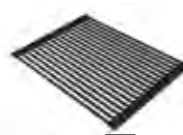

157
Euro
ARS023BK **88**
ARS013BK **80**
Pag. 173-174

156 157
Q440 - 430 Q200

152 Element
Colander 418



AVP035BK
Euro **64**
Pag. 173

Solo Quadra 200

QUADRA 200

Lavello 2 vasche

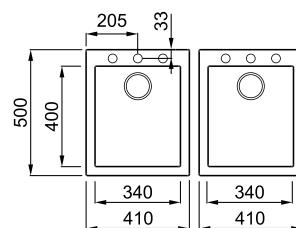

Disegno Tecnico approfondito: QR code a pag. 91



CARATTERISTICHE

Dimensioni (mm) **410 x 500 + 410 x 500**
 Base (mm) **900**
 Foro da incasso (mm) **390 x 480 + 390 x 480**
 (distanza minima 50 mm)
 Profondità Vasca 1 (mm) **190**
 Profondità Vasca 2 (mm) **190**
 Orientamento **Non reversibile**

ACCESSORI CONSIGLIATI

91 97 25 50 152 157 163 4 5 61 75 43 146 147 9

MATERIALI E COLORI

KERATEK plus
CERAMIC NANOTECHNOLOGY CNG

- | | | |
|------------------|----------|-----------------|
| ● K99 Dark Grey | LKQ20099 | Euro 642 |
| ● K97 Light Grey | LKQ20097 | |
| ○ K96 White | LKQ20096 | |
| ● K95 Champagne | LKQ20095 | |
| ● K93 Dove Grey | LKQ20093 | |
| ● K86 Black | LKQ20086 | |

GRANITEK
NATURAL GRANITE EFFECT

- | | |
|-----------------|-----------------|
| METAL | Euro 511 |
| ● M79 Aluminium | LMQ20079 |
| ● M78 Espresso | LMQ20078 |
| ● M73 Titanium | LMQ20073 |
| ● M70 Ghisa | LMQ20070 |

GRANITEK
NATURAL GRANITE EFFECT

- | | |
|---------------------|-----------------|
| MATT | Euro 490 |
| ○ G68 Bianco | LGQ20068 |
| ● G48 Cemento | LGQ20048 |
| ● G43 Tortora | LGQ20043 |
| ● G40 Nero | LGQ20040 |
| CLASSIC | |
| ● G62 Bianco Antico | LGQ20062 |
| ● G59 Antracite | LGQ20059 |
| ● G54 Nero Pietra | LGQ20054 |
| ● G52 Bianco Pietra | LGQ20052 |
| ● G51 Avena | LGQ20051 |



75 Cestello



ACI01307
 Euro **101**
 Pag. 178

97 Element Pop-Up
 Push Control



ASP13002
 Euro **37**
 Pag. 171

162 Panni in Microfibra
 Fast Clean



DKP01001
 Pag. 177





COLLEZIONE

QUADRA

SOTTOTOP

QUANDO LA CREATIVITÀ SI
TRASFORMA IN FUNZIONALITÀ.

COLLEZIONE

QUADRA SOTTOTOP

Questa collezione è stata pensata per ottimizzare al massimo l'incasso del lavello per raggiungere una totale pulizia del top da cucina.



SOTTOTOP



Lavello Quadra 130 Sottotop G40 Nero con miscelatore Adige G40 Nero

800

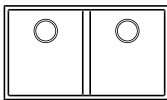
**QUADRA 350**
PAG. 102

600

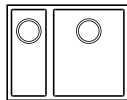
**QUADRA 150**
PAG. 102

800

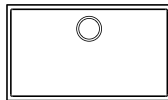
**QUADRA 130**
PAG. 103

800

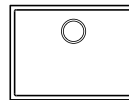
**QUADRA 110**
PAG. 103

600

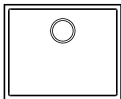
**QUADRA 105**
PAG. 104

500

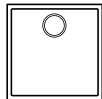
**QUADRA 102**
PAG. 104

NEW

450

**QUADRA 100**
PAG. 105

300

**QUADRA 50**
PAG. 105

900

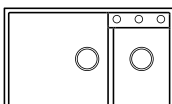
**QUADRA 440**
PAG. 106

900

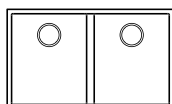
**QUADRA 340**
PAG. 106

900

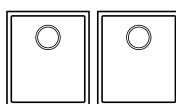
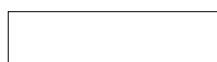
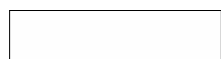
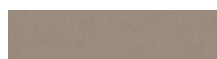
**QUADRA 200**
PAG. 107DISEGNI TECNICI
APPROFONDITI
LINEA QUADRA
SOTTOTOP**Corredo del lavello:** Sifone salvaspazio, pilette e ganci.**KERATEK** Plus
CERAMIC NANOTECHNOLOGY CN6**K99** Dark Grey**K97** Light Grey**K96** White**K95** Champagne**K93** Dove Grey**K86** Black**GRANITEK**
NATURAL GRANITE EFFECT**M79** Aluminium**M78** Espresso**M73** Titanium**M70** Ghisa**G68** Bianco**G48** Cemento**G43** Tortora**G40** Nero**G62** Bianco Antico**G59** Antracite**G54** Nero Pietra**G52** Bianco Pietra**G51** Avena**ESTETICA**

Dalla giuntura tra vasca e piano situata sottotop, scaturiscono i vantaggi di eleganza e facilità di pulizia della linea Quadra Sottotop.

**INSTALLAZIONE
MIXER SU TOP**

Nella linea Quadra Sottotop il miscelatore si installa sul top di lavoro.

**ACCESSORI ELEMENT**

Tagliere, drainer flex e colander permettono di completare il lavello a proprio gusto e piacimento, rendendo le operazioni di preparazione del cibo più facili e pratiche.

**ACCESSORIO ELEMENT
COVER MATERICA**

Quel tocco di classe in più. La cover pilettina materica è realizzata negli stessi materiali e colori del lavello, esaltando gli accordi estetici tra gli elementi e valorizzando l'ambiente circostante.

QUADRA 350 SOTTOTOP

Lavello 2 vasche

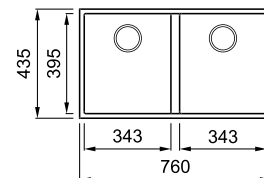

Disegno Tecnico approfondito: QR code a pag. 101



Installazione miscelatore sul top

CARATTERISTICHE

Dimensioni (mm)	760 x 435
Base (mm)	800
Foro da incasso (mm)	720 x 395 R5
Profondità Vasca 1 (mm)	220
Profondità Vasca 2 (mm)	220
Orientamento	Non reversibile

ACCESSORI CONSIGLIATI



MATERIALI E COLORI

KERATEK plus
CERAMIC NANOTECHNOLOGY CN8

● K99 Dark Grey	LKQ35099BSO	Euro 593
● K97 Light Grey	LKQ35097BSO	
○ K96 White	LKQ35096BSO	
● K95 Champagne	LKQ35095BSO	
● K93 Dove Grey	LKQ35093BSO	
● K86 Black	LKQ35086BSO	

GRANITEK
NATURAL GRANITE EFFECT

METAL

● M79 Aluminium	LMQ35079BSO	Euro 494
● M78 Espresso	LMQ35078BSO	
● M73 Titanium	LMQ35073BSO	
● M70 Ghisa	LMQ35070BSO	

GRANITEK
NATURAL GRANITE EFFECT

MATT

○ G68 Bianco	LGQ35068BSO	Euro 463
● G48 Cemento	LGQ35048BSO	
● G43 Tortora	LGQ35043BSO	
● G40 Nero	LGQ35040BSO	

CLASSIC

● G62 Bianco Antico	LGQ35062BSO
● G59 Antracite	LGQ35059BSO
● G54 Nero Pietra	LGQ35054BSO
● G52 Bianco Pietra	LGQ35052BSO
● G51 Avena	LGQ35051BSO

QUADRA 150 SOTTOTOP

Lavello 2 vasche

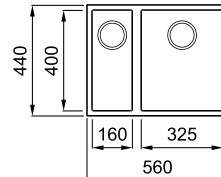

Disegno Tecnico approfondito: QR code a pag. 101



Installazione miscelatore sul top

CARATTERISTICHE

Dimensioni (mm)	560 x 440
Base (mm)	600
Foro da incasso (mm)	520 x 400 R5
Profondità Vasca 1 (mm)	200
Profondità Vasca 2 (mm)	155
Orientamento	Non reversibile

ACCESSORI CONSIGLIATI

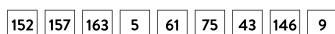

MATERIALI E COLORI

KERATEK plus
CERAMIC NANOTECHNOLOGY CN8

● K99 Dark Grey	LKQ15099BSO	Euro 516
● K97 Light Grey	LKQ15097BSO	
○ K96 White	LKQ15096BSO	
● K95 Champagne	LKQ15095BSO	
● K93 Dove Grey	LKQ15093BSO	
● K86 Black	LKQ15086BSO	

GRANITEK
NATURAL GRANITE EFFECT

METAL

● M79 Aluminium	LMQ15079BSO	Euro 424
● M78 Espresso	LMQ15078BSO	
● M73 Titanium	LMQ15073BSO	
● M70 Ghisa	LMQ15070BSO	

GRANITEK
NATURAL GRANITE EFFECT

MATT

○ G68 Bianco	LGQ15068BSO	Euro 402
● G48 Cemento	LGQ15048BSO	
● G43 Tortora	LGQ15043BSO	
● G40 Nero	LGQ15040BSO	

CLASSIC

● G62 Bianco Antico	LGQ15062BSO
● G59 Antracite	LGQ15059BSO
● G54 Nero Pietra	LGQ15054BSO
● G52 Bianco Pietra	LGQ15052BSO
● G51 Avena	LGQ15051BSO

157 Element Drainer Flex 440

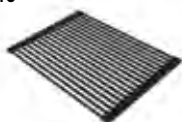

ARS013BK
Euro **80**
Pag. 174

152 Element Colander 418



AVP035BK
Euro **64**
Pag. 173

75 Cestello



ACI01307
Euro **101**
Pag. 178

QUADRA 130 SOTTOTOP

Lavello 1 vasca

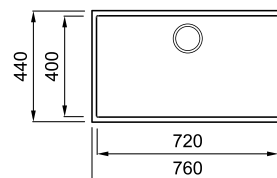

Disegno Tecnico approfondito: QR code a pag. 101



Installazione miscelatore sul top

CARATTERISTICHE

Dimensioni (mm)	760 x 440
Base (mm)	800
Foro da incasso (mm)	720 x 400 R5
Profondità Vasca (mm)	200
Orientamento	Non reversibile

ACCESSORI CONSIGLIATI

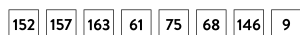

MATERIALI E COLORI

KERATEK plus
CERAMIC NANOTECHNOLOGY CNG

● K99 Dark Grey	LKQ13099BSO	Euro 516
● K97 Light Grey	LKQ13097BSO	
○ K96 White	LKQ13096BSO	
● K95 Champagne	LKQ13095BSO	
● K93 Dove Grey	LKQ13093BSO	
● K86 Black	LKQ13086BSO	

GRANITEK
NATURAL GRANITE EFFECT

Euro **424**

METAL

● M79 Aluminium	LMQ13079BSO
● M78 Espresso	LMQ13078BSO
● M73 Titanium	LMQ13073BSO
● M70 Ghisa	LMQ13070BSO

GRANITEK
NATURAL GRANITE EFFECT

MATT

○ G68 Bianco	LGQ13068BSO	Euro 402
● G48 Cemento	LGQ13048BSO	
● G43 Tortora	LGQ13043BSO	
● G40 Nero	LGQ13040BSO	

CLASSIC

● G62 Bianco Antico	LGQ13062BSO
● G59 Antracite	LGQ13059BSO
● G54 Nero Pietra	LGQ13054BSO
● G52 Bianco Pietra	LGQ13052BSO
● G51 Avena	LGQ13051BSO

QUADRA 110 SOTTOTOP

Lavello 1 vasca

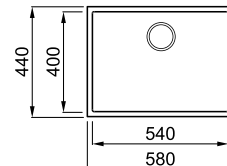

Disegno Tecnico approfondito: QR code a pag. 101



Installazione miscelatore sul top

CARATTERISTICHE

Dimensioni (mm)	580 x 440
Base (mm)	800
Foro da incasso (mm)	540 x 400 R5
Profondità Vasca (mm)	190
Orientamento	Non reversibile

ACCESSORI CONSIGLIATI

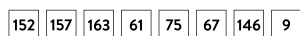

MATERIALI E COLORI

KERATEK plus
CERAMIC NANOTECHNOLOGY CNG

● K99 Dark Grey	LKQ11099BSO	Euro 468
● K97 Light Grey	LKQ11097BSO	
○ K96 White	LKQ11096BSO	
● K95 Champagne	LKQ11095BSO	
● K93 Dove Grey	LKQ11093BSO	
● K86 Black	LKQ11086BSO	

GRANITEK
NATURAL GRANITE EFFECT

Euro **390**

METAL

● M79 Aluminium	LMQ11079BSO
● M78 Espresso	LMQ11078BSO
● M73 Titanium	LMQ11073BSO
● M70 Ghisa	LMQ11070BSO

GRANITEK
NATURAL GRANITE EFFECT

MATT

○ G68 Bianco	LGQ11068BSO	Euro 366
● G48 Cemento	LGQ11048BSO	
● G43 Tortora	LGQ11043BSO	
● G40 Nero	LGQ11040BSO	

CLASSIC

● G62 Bianco Antico	LGQ11062BSO
● G59 Antracite	LGQ11059BSO
● G54 Nero Pietra	LGQ11054BSO
● G52 Bianco Pietra	LGQ11052BSO
● G51 Avena	LGQ11051BSO

163 Element Cover
Piletta Materica



AKCP1248
Euro **42**
Pag. 174

Bottom Grid

Euro
AGB01300 **71** 43
AGB01303 **104** 68
AGB01304 **88** 67

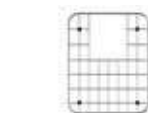

43 Q350/150
68 Q130
67 Q110

160 Spray Detergente
Sgrassante Daily Clean



DLL01601
Pag. 175

QUADRA 105 SOTTOTOP

Lavello 1 vasca

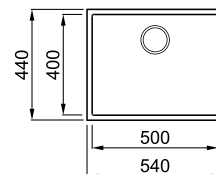

Disegno Tecnico approfondito: QR code a pag. 101



Installazione miscelatore sul top

CARATTERISTICHE

Dimensioni (mm)	540 x 440
Base (mm)	600
Foro da incasso (mm)	500 x 400 R5
Profondità Vasca (mm)	200
Orientamento	Non reversibile

ACCESSORI CONSIGLIATI

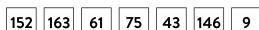

MATERIALI E COLORI

KERATEK plus
CERAMIC NANOTECHNOLOGY CNS

Euro **468**

● K99 Dark Grey	LKQ10599BSO
● K97 Light Grey	LKQ10597BSO
○ K96 White	LKQ10596BSO
● K95 Champagne	LKQ10595BSO
● K93 Dove Grey	LKQ10593BSO
● K86 Black	LKQ10586BSO

GRANITEK
NATURAL GRANITE EFFECT

Euro **390**

METAL

● M79 Aluminium	LMQ10579BSO
● M78 Espresso	LMQ10578BSO
● M73 Titanium	LMQ10573BSO
● M70 Ghisa	LMQ10570BSO

GRANITEK
NATURAL GRANITE EFFECT

Euro **366**

MATT

○ G68 Bianco	LGQ10568BSO
● G48 Cemento	LGQ10548BSO
● G43 Tortora	LGQ10543BSO
● G40 Nero	LGQ10540BSO

CLASSIC

● G62 Bianco Antico	LGQ10562BSO
● G59 Antracite	LGQ10559BSO
● G54 Nero Pietra	LGQ10554BSO
● G52 Bianco Pietra	LGQ10552BSO
● G51 Avena	LGQ10551BSO

QUADRA 102 SOTTOTOP

Lavello 1 vasca

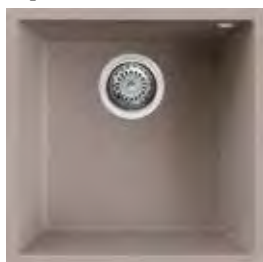

NEW

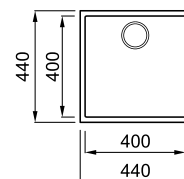

Disegno Tecnico approfondito: QR code a pag. 101



Installazione miscelatore sul top

CARATTERISTICHE

Dimensioni (mm)	440 x 440
Base (mm)	500
Foro da incasso (mm)	400 x 400 R5
Profondità Vasca (mm)	200
Orientamento	Non reversibile

ACCESSORI CONSIGLIATI

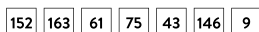

MATERIALI E COLORI

KERATEK plus
CERAMIC NANOTECHNOLOGY CNS

Euro **468**

● K99 Dark Grey	LKQ10299BSO
● K97 Light Grey	LKQ10297BSO
○ K96 White	LKQ10296BSO
● K95 Champagne	LKQ10295BSO
● K93 Dove Grey	LKQ10293BSO
● K86 Black	LKQ10286BSO

GRANITEK
NATURAL GRANITE EFFECT

Euro **390**

METAL

● M79 Aluminium	LMQ10279BSO
● M78 Espresso	LMQ10278BSO
● M73 Titanium	LMQ10273BSO
● M70 Ghisa	LMQ10270BSO

GRANITEK
NATURAL GRANITE EFFECT

Euro **366**

MATT

○ G68 Bianco	LGQ10268BSO
● G48 Cemento	LGQ10248BSO
● G43 Tortora	LGQ10243BSO
● G40 Nero	LGQ10240BSO

CLASSIC

● G62 Bianco Antico	LGQ10262BSO
● G59 Antracite	LGQ10259BSO
● G54 Nero Pietra	LGQ10254BSO
● G52 Bianco Pietra	LGQ10252BSO
● G51 Avena	LGQ10251BSO

152 **Element**
Colander 418



AVP035BK
Euro **64**
Pag. 173

Escluso Quadra 50

75 **Cestello**



ACI01307
Euro **101**
Pag. 178

43 **Bottom Grid**



AGB01300
Euro **71**
Pag. 179

Escluso Quadra 50

QUADRA 100 SOTTOTOP

Lavello 1 vasca

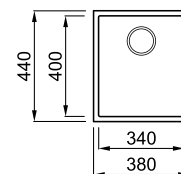

Disegno Tecnico approfondito: QR code a pag. 101



Installazione miscelatore sul top

CARATTERISTICHE

Dimensioni (mm)	380 x 440
Base (mm)	450
Foro da incasso (mm)	340 x 400 R5
Profondità Vasca (mm)	190
Orientamento	Non reversibile

ACCESSORI CONSIGLIATI

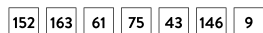

MATERIALI E COLORI

KERATEK plus
CERAMIC NANOTECHNOLOGY CNG

● K99 Dark Grey	LKQ10099BSO	Euro 375
● K97 Light Grey	LKQ10097BSO	
○ K96 White	LKQ10096BSO	
● K95 Champagne	LKQ10095BSO	
● K93 Dove Grey	LKQ10093BSO	
● K86 Black	LKQ10086BSO	

GRANITEK
NATURAL GRANITE EFFECT

METAL		
● M79 Aluminium	LMQ10079BSO	Euro 306
● M78 Espresso	LMQ10078BSO	
● M73 Titanium	LMQ10073BSO	
● M70 Ghisa	LMQ10070BSO	

GRANITEK
NATURAL GRANITE EFFECT

MATT		
○ G68 Bianco	LGQ10068BSO	Euro 295
● G48 Cemento	LGQ10048BSO	
● G43 Tortora	LGQ10043BSO	
● G40 Nero	LGQ10040BSO	
CLASSIC		
● G62 Bianco Antico	LGQ10062BSO	
● G59 Antracite	LGQ10059BSO	
● G54 Nero Pietra	LGQ10054BSO	
● G52 Bianco Pietra	LGQ10052BSO	
● G51 Avena	LGQ10051BSO	

QUADRA 50 SOTTOTOP

Lavello 1 vasca

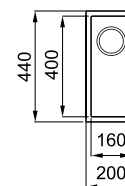

Disegno Tecnico approfondito: QR code a pag. 101



Installazione miscelatore sul top

CARATTERISTICHE

Dimensioni (mm)	200 x 440
Base (mm)	300
Foro da incasso (mm)	160 x 400 R5
Profondità Vasca (mm)	155
Orientamento	Non reversibile

ACCESSORI CONSIGLIATI



MATERIALI E COLORI

KERATEK plus
CERAMIC NANOTECHNOLOGY CNG

● K99 Dark Grey	LKQ05099BSO	Euro 314
● K97 Light Grey	LKQ05097BSO	
○ K96 White	LKQ05096BSO	
● K95 Champagne	LKQ05095BSO	
● K93 Dove Grey	LKQ05093BSO	
● K86 Black	LKQ05086BSO	

GRANITEK
NATURAL GRANITE EFFECT

METAL		
● M79 Aluminium	LMQ05079BSO	Euro 261
● M78 Espresso	LMQ05078BSO	
● M73 Titanium	LMQ05073BSO	
● M70 Ghisa	LMQ05070BSO	

GRANITEK
NATURAL GRANITE EFFECT

MATT		
○ G68 Bianco	LGQ05068BSO	Euro 248
● G48 Cemento	LGQ05048BSO	
● G43 Tortora	LGQ05043BSO	
● G40 Nero	LGQ05040BSO	
CLASSIC		
● G62 Bianco Antico	LGQ05062BSO	
● G59 Antracite	LGQ05059BSO	
● G54 Nero Pietra	LGQ05054BSO	
● G52 Bianco Pietra	LGQ05052BSO	
● G51 Avena	LGQ05051BSO	

163 Element Cover
Piletta Materica



AKCP1248
Euro **42**
Pag. 174

146 Cover piletta



ACPM1000
Euro **21**
Pag. 179

158 Spray Anticalcare
Disincrostante Daily Clean



DLA01601
Pag. 176

QUADRA 440 SOTTOTOP

Lavello 2 vasche

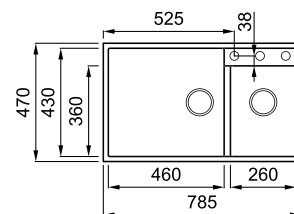

Disegno Tecnico approfondito: QR code a pag. 101



CARATTERISTICHE

Dimensioni (mm)	785 x 470
Base (mm)	900
Foro da incasso (mm)	745 x 430 R5
Profondità Vasca 1 (mm)	215
Profondità Vasca 2 (mm)	190
Orientamento	Non reversibile

MATERIALI E COLORI

GRANITEK
NATURAL GRANITE EFFECT

Euro **570**

METAL

- M79 Aluminium LMQ44079BSO
- M73 Titanium LMQ44073BSO

GRANITEK
NATURAL GRANITE EFFECT

Euro **538**

MATT

- G68 Bianco LGQ44068BSO
- G43 Tortora LGQ44043BSO
- G40 Nero LGQ44040BSO

CLASSIC

- G51 Avena LGQ44051BSO

ACCESSORI CONSIGLIATI

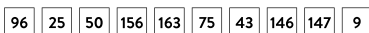

QUADRA 340 SOTTOTOP

Lavello 2 vasche

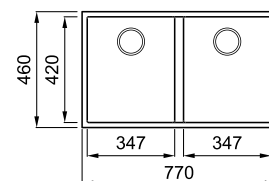

Disegno Tecnico approfondito: QR code a pag. 101



Installazione miscelatore sul top

CARATTERISTICHE

Dimensioni (mm)	770 x 460
Base (mm)	900
Foro da incasso (mm)	730 x 420 R5
Profondità Vasca 1 (mm)	215
Profondità Vasca 2 (mm)	215
Orientamento	Non reversibile

MATERIALI E COLORI

GRANITEK
NATURAL GRANITE EFFECT

Euro **543**

METAL

- M79 Aluminium LMQ34079BSC
- M73 Titanium LMQ34073BSC

GRANITEK
NATURAL GRANITE EFFECT

Euro **513**

MATT

- G68 Bianco LGQ34068BSC
- G43 Tortora LGQ34043BSC
- G40 Nero LGQ34040BSC

CLASSIC

- G51 Avena LGQ34051BSC

ACCESSORI CONSIGLIATI

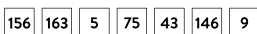

156 Element Drainer Flex
500 - 440
157

Euro
ARS023BK **88**
ARS013BK **80**
Pag. 173-174

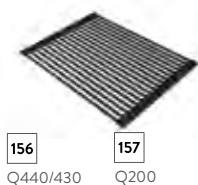

152 Element
Colander 418

AVP035BK
Euro **64**
Pag. 173



50 Element Dispenser
Sapone Quadrato

ADI02301
Euro **102**
Pag. 172



QUADRA 200 SOTTOTOP

Lavello 2 vasche

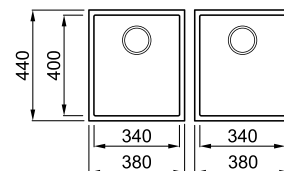

Disegno Tecnico approfondito: QR code a pag. 101



Installazione miscelatore sul top

CARATTERISTICHE

Dimensioni (mm) **380 x 440 + 380 x 440**
 Base (mm) **900**
 Foro da incasso (mm) **340 x 400 R5 + 340 x 400 R5**
 (distanza minima 50mm)
 Profondità Vasca 1 (mm) **190**
 Profondità Vasca 2 (mm) **190**
 Orientamento **Non reversibile**

ACCESSORI CONSIGLIATI

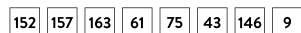

MATERIALI E COLORI

KERATEK plus
CERAMIC NANOTECHNOLOGY CNG

● K99 Dark Grey	LKQ20099BSO	Euro 677
● K97 Light Grey	LKQ20097BSO	
○ K96 White	LKQ20096BSO	
● K95 Champagne	LKQ20095BSO	
● K93 Dove Grey	LKQ20093BSO	
● K86 Black	LKQ20086BSO	

GRANITEK
NATURAL GRANITE EFFECT

METAL

● M79 Aluminium	LMQ20079BSO	Euro 553
● M78 Espresso	LMQ20078BSO	
● M73 Titanium	LMQ20073BSO	
● M70 Ghisa	LMQ20070BSO	

GRANITEK
NATURAL GRANITE EFFECT

MATT

○ G68 Bianco	LGQ20068BSO	Euro 531
● G48 Cemento	LGQ20048BSO	
● G43 Tortora	LGQ20043BSO	
● G40 Nero	LGQ20040BSO	

CLASSIC

● G62 Bianco Antico	LGQ20062BSO
● G59 Antracite	LGQ20059BSO
● G54 Nero Pietra	LGQ20054BSO
● G52 Bianco Pietra	LGQ20052BSO
● G51 Avena	LGQ20051BSO



75 Cestello



ACI01307
 Euro **101**
 Pag. 178

43 Bottom Grid



AGB01300
 Euro **71**
 Pag. 179

162 Panni in Microfibra
 Fast Clean



DKP01001
 Pag. 177





COLLEZIONE

UNICO

ELOGIO DELL'UNICITÀ

COLLEZIONE

UNICO

Unicità è una parola magica. Essere unici significa immaginare e creare prodotti e spazi che non c'erano, sentirsi meglio con se stessi, provare strade mai percorse per tracciare una nuova rotta. La tua.



SOPRATOP



Lavello Unico 480 M73 Titanium con miscelatore Cloud M73 Titanium

800

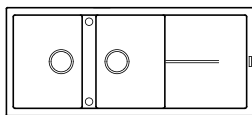

UNICO 500
PAG. 112

600

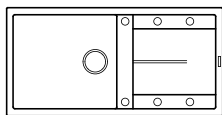

UNICO 480
PAG. 112

600

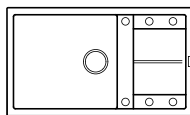

UNICO 410
PAG. 113

600

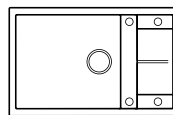

UNICO 310
PAG. 113

500

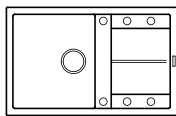

UNICO 300
PAG. 114

500

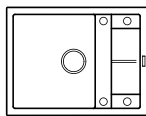

UNICO 125
PAG. 114

corner

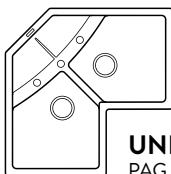

NEW

UNICO CORNER
PAG. 115



DISEGNI TECNICI
APPROFONDITI
LINEA UNICO

Corredo del lavello: Sifone salvaspazio, pilette e ganci.

KERATEK^{Plus}
CERAMIC NANOTECHNOLOGY CN6



K97 Light Grey

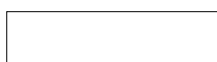

K96 White



K93 Dove Grey



K86 Black

GRANITEK
NATURAL GRANITE EFFECT

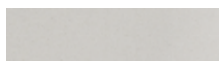

M79 Aluminium



M73 Titanium

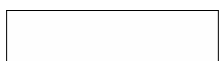

G68 Bianco



G48 Cemento

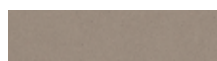

G43 Tortora



G40 Nero

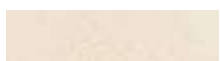

G62 Bianco Antico



G59 Antracite



G55 Grigio Pietra



G54 Nero Pietra



G52 Bianco Pietra



G51 Avena



VASCA XL

Vasca dallo spazio ampio e maggiorato per ospitare utensili di grandi dimensioni e facilitare le operazioni di utilizzo.



ACCESSORI ELEMENT

Il tagliere e il drainer flex permettono di completare il lavello a proprio gusto e piacimento, rendendo le operazioni di preparazione del cibo più facili e pratiche.



AREA ACCESSORI INTEGRATA

Area dotata di prefori che permette di installare una molteplicità di accessori: piletta salterello, miscelatore, dispenser del sapone ad ingombro ridotto.



ACCESSORIO ELEMENT COVER MATERICA

Quel tocco di classe in più. La cover piletta materica è realizzata negli stessi materiali e colori del lavello, esaltando gli accordi estetici tra gli elementi e valorizzando l'ambiente circostante.

UNICO 500



CARATTERISTICHE

Dimensioni (mm)	1160 x 500
Base (mm)	800
Foro da incasso (mm)	1140 x 480
Profondità Vasca 1 (mm)	200
Profondità Vasca 2 (mm)	200
Orientamento	Reversibile

ACCESSORI CONSIGLIATI

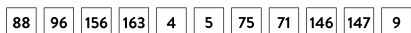

Lavello 2 vasche con gocciolatoio

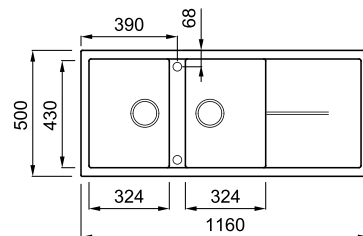

Disegno Tecnico approfondito: QR code a pag. 111

MATERIALI E COLORI

KERATEK plus CERAMIC NANOTECHNOLOGY CN8 Euro **617**

- K97 Light Grey LKU50097
- K96 White LKU50096
- K93 Dove Grey LKU50093
- K86 Black LKU50086

GRANITEK NATURAL GRANITE EFFECT Euro **495**

- METAL
- M79 Aluminium LMU50079
 - M73 Titanium LMU50073

GRANITEK NATURAL GRANITE EFFECT Euro **474**

- MATT
- G68 Bianco LGU50068
 - G48 Cemento LGU50048
 - G43 Tortora LGU50043
 - G40 Nero LGU50040

- CLASSIC
- G62 Bianco Antico LGU50062
 - G59 Antracite LGU50059
 - G51 Avena LGU50051

UNICO 480



CARATTERISTICHE

Dimensioni (mm)	1000 x 500
Base (mm)	600
Foro da incasso (mm)	980 x 480
Profondità Vasca (mm)	200
Orientamento	Reversibile

ACCESSORI CONSIGLIATI

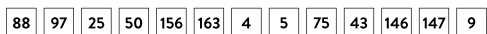

Lavello 1 vasca con gocciolatoio

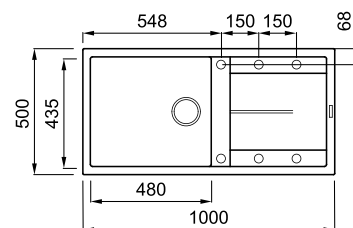

Disegno Tecnico approfondito: QR code a pag. 111

MATERIALI E COLORI

KERATEK plus CERAMIC NANOTECHNOLOGY CN8 Euro **614**

- K97 Light Grey LKU48097
- K96 White LKU48096
- K93 Dove Grey LKU48093
- K86 Black LKU48086

GRANITEK NATURAL GRANITE EFFECT Euro **492**

- METAL
- M79 Aluminium LMU48079
 - M73 Titanium LMU48073

GRANITEK NATURAL GRANITE EFFECT Euro **468**

- MATT
- G68 Bianco LGU48068
 - G48 Cemento LGU48048
 - G43 Tortora LGU48043
 - G40 Nero LGU48040

- CLASSIC
- G62 Bianco Antico LGU48062
 - G59 Antracite LGU48059
 - G51 Avena LGU48051

88 Element Tagliere Sliding 50cm



ATH010QU
Euro **147**
Pag. 168

156 Element Drainer Flex 500

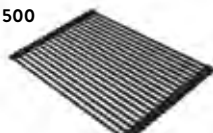

ARS023BK
Euro **88**
Pag. 173

163 Element Cover Piletta Materica



AKCP1297
Euro **42**
Pag. 174

UNICO 410



CARATTERISTICHE

Dimensioni (mm)	860 x 500
Base (mm)	600
Foro da incasso (mm)	840 x 480
Profondità Vasca (mm)	200
Orientamento	Reversibile

ACCESSORI CONSIGLIATI



Lavello 1 vasca con gocciolatoio

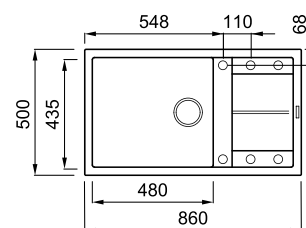

Disegno Tecnico approfondito: QR code a pag. 111

MATERIALI E COLORI

KERATEK plus
CERAMIC NANOTECHNOLOGY CNG

Euro 545	
● K97 Light Grey	LKU41097
○ K96 White	LKU41096
● K93 Dove Grey	LKU41093
● K86 Black	LKU41086

GRANITEK
NATURAL GRANITE EFFECT

Euro 438	
METAL	
● M79 Aluminium	LMU41079
● M73 Titanium	LMU41073

GRANITEK
NATURAL GRANITE EFFECT

Euro 417	
MATT	
○ G68 Bianco	LGU41068
● G48 Cemento	LGU41048
● G43 Tortora	LGU41043
● G40 Nero	LGU41040

CLASSIC

● G62 Bianco Antico	LGU41062
● G59 Antracite	LGU41059
● G51 Avena	LGU41051

UNICO 310



CARATTERISTICHE

Dimensioni (mm)	780 x 500
Base (mm)	600
- se inizio composizione	800
Foro da incasso (mm)	760 x 480
Profondità Vasca (mm)	200
Orientamento	Reversibile

ACCESSORI CONSIGLIATI

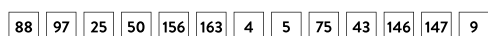

Lavello 1 vasca con gocciolatoio

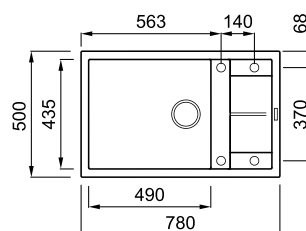

Disegno Tecnico approfondito: QR code a pag. 111

MATERIALI E COLORI

KERATEK plus
CERAMIC NANOTECHNOLOGY CNG

Euro 545	
● K97 Light Grey	LKU31097
○ K96 White	LKU31096
● K93 Dove Grey	LKU31093
● K86 Black	LKU31086

GRANITEK
NATURAL GRANITE EFFECT

Euro 438	
METAL	
● M79 Aluminium	LMU31079
● M73 Titanium	LMU31073

GRANITEK
NATURAL GRANITE EFFECT

Euro 417	
MATT	
○ G68 Bianco	LGU31068
● G48 Cemento	LGU31048
● G43 Tortora	LGU31043
● G40 Nero	LGU31040

CLASSIC

● G62 Bianco Antico	LGU31062
● G59 Antracite	LGU31059
● G51 Avena	LGU31051

97 Element Pop-Up
Push Control



ASP13002
Euro **37**
Pag. 171

75 Cestello



ACI01307
Euro **101**
Pag. 178

160 Spray Detergente
Sgrassante Daily Clean



DLL01601
Pag. 175

UNICO 300



Lavello 1 vasca con gocciolatoio

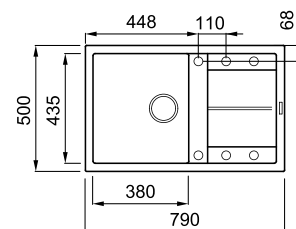

Disegno Tecnico approfondito: QR code a pag. 111



CARATTERISTICHE

Dimensioni (mm)	790 x 500
Base (mm)	500
Foro da incasso (mm)	770 x 480
Profondità Vasca (mm)	200
Orientamento	Reversibile

MATERIALI E COLORI

KERATEK CERAMIC NANOTECHNOLOGY CN8 Euro **532**

● K97 Light Grey	LKU30097
○ K96 White	LKU30096
● K93 Dove Grey	LKU30093
● K86 Black	LKU30086

GRANITEK NATURAL GRANITE EFFECT Euro **428**

METAL	
● M79 Aluminium	LMU30079
● M73 Titanium	LMU30073

GRANITEK NATURAL GRANITE EFFECT Euro **410**

MATT	
○ G68 Bianco	LGU30068
● G48 Cemento	LGU30048
● G43 Tortora	LGU30043
● G40 Nero	LGU30040

CLASSIC	
● G62 Bianco Antico	LGU30062
● G59 Antracite	LGU30059
● G51 Avena	LGU30051

ACCESSORI CONSIGLIATI



UNICO 125



Lavello 1 vasca con gocciolatoio

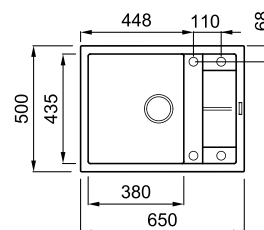

Disegno Tecnico approfondito: QR code a pag. 111

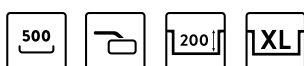

CARATTERISTICHE

Dimensioni (mm)	650 x 500
Base (mm)	500
Foro da incasso (mm)	630 x 480
Profondità Vasca (mm)	200
Orientamento	Reversibile

MATERIALI E COLORI

KERATEK CERAMIC NANOTECHNOLOGY CN8 Euro **490**

● K97 Light Grey	LKU12597
○ K96 White	LKU12596
● K93 Dove Grey	LKU12593
● K86 Black	LKU12586

GRANITEK NATURAL GRANITE EFFECT Euro **395**

METAL	
● M79 Aluminium	LMU12579
● M73 Titanium	LMU12573

GRANITEK NATURAL GRANITE EFFECT Euro **376**

MATT	
○ G68 Bianco	LGU12568
● G48 Cemento	LGU12548
● G43 Tortora	LGU12543
● G40 Nero	LGU12540

CLASSIC	
● G62 Bianco Antico	LGU12562
● G59 Antracite	LGU12559
● G51 Avena	LGU12551

ACCESSORI CONSIGLIATI

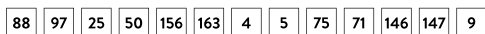

88 Element Tagliere Sliding 50cm



ATH010BK
Euro **147**
Pag. 168

156 Element Drainer Flex 500

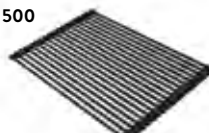

ARS023BK
Euro **88**
Pag. 173

146 Cover piletta



ACPM1000
Euro **21**
Pag. 179

UNICO CORNER

Lavello angolare 2 vasche con gocciolatoio



NEW

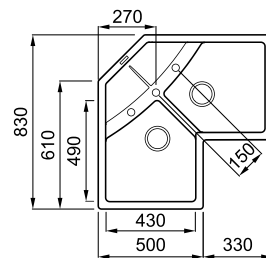

Disegno Tecnico approfondito: QR code a pag. 111



CARATTERISTICHE

Dimensioni (mm) **830 x 830**
 Base (mm) **Angolare**
 Foro da incasso (mm) **da disegno**
 Profondità Vasca 1 (mm) **190**
 Profondità Vasca 2 (mm) **190**
 Orientamento **Reversibile**

ACCESSORI CONSIGLIATI

88 96 25 50 156 163 4 5 75 146 147 9

MATERIALI E COLORI

GRANITEK
 NATURAL GRANITE EFFECT

Euro **683**

METAL

- M79 Aluminium LMUCOR79
- M73 Titanium LMUCOR73

GRANITEK
 NATURAL GRANITE EFFECT

Euro **652**

MATT

- G68 Bianco LGUCOR68
- G48 Cemento LGUCOR48
- G43 Tortora LGUCOR43
- G40 Nero LGUCOR40

CLASSIC

- G62 Bianco Antico LGUCOR62
- G59 Antracite LGUCOR59
- G55 Grigio Pietra LGUCOR55
- G54 Nero Pietra LGUCOR54
- G52 Bianco Pietra LGUCOR52
- G51 Avena LGUCOR51



97 Element Pop-Up
 Push Control



ASP13002
 Euro **37**
 Pag. 171

71 Bottom Grid S



AGB01306
 Euro **78**
 Pag. 179

Escluso Unico
 Corner

158 Spray Anticalcare
 Disincrostante Daily Clean



DLA01601
 Pag. 176





COLLEZIONE
EGO

DAL DESIGN AVVOLGENTE

COLLEZIONE

EGO

Una collezione di lavelli studiata per incontrare morbidi gusti. Le linee che la compongono sono molto leggere e formano delle curve che ne conferiscono un design avvolgente. Ogni modello è combinabile con numerosi accessori e molteplici colorazioni.



SOPRATOP



Lavello Ego 500 G68 Bianco con miscelatore Volta G68 Bianco

800

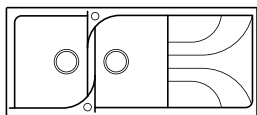

EGO 500
PAG. 120

600

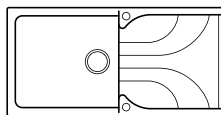

EGO 480
PAG. 120

600

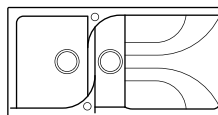

EGO 475
PAG. 121

900

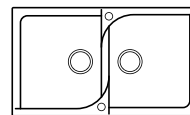

EGO 450
PAG. 121

450

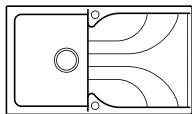

EGO 400
PAG. 122

800

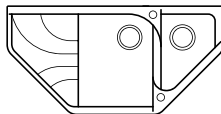

EGO ESA
PAG. 122

corner

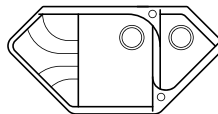

EGO CORNER
PAG. 123

500

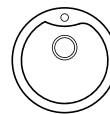

EGO ROUND
PAG. 123



DISEGNI TECNICI
APPROFONDITI
LINEA EGO

Corredo del lavello: Sifone salvaspazio, pilette e ganci.

GRANITEK
NATURAL GRANITE EFFECT

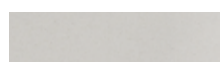

M79 Aluminium



M73 Titanium



M70 Ghisa



G68 Bianco



G48 Cemento



G43 Tortora



G40 Nero



G62 Bianco Antico



G59 Antracite



G54 Nero Pietra



G52 Bianco Pietra



G51 Avena



DESIGN AVVOLGENTE

Le leggere linee estetiche di Ego formano delle curve che le conferiscono un design avvolgente.



ACCESSORI ELEMENT

Tagliere, drainer flex e pop up permettono di completare il lavello a proprio gusto e piacimento, rendendo le operazioni di preparazione del cibo più facili e pratiche.



ACCESSORIO ELEMENT COVER MATERICA

Quel tocco di classe in più. La cover piletta materica è realizzata negli stessi materiali e colori del lavello, esaltando gli accordi estetici tra gli elementi e valorizzando l'ambiente circostante.

EGO 500



Lavello 2 vasche con gocciolatoio

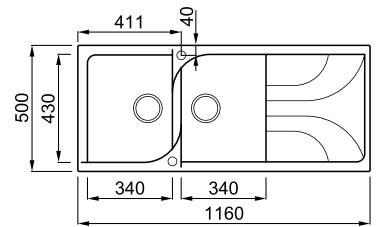

Disegno Tecnico approfondito: QR code a pag. 119



CARATTERISTICHE

Dimensioni (mm)	1160 x 500
Base (mm)	800
Foro da incasso (mm)	1140 x 485
Profondità Vasca 1 (mm)	210
Profondità Vasca 2 (mm)	210
Orientamento	Reversibile

MATERIALI E COLORI

GRANITEK
NATURAL GRANITE EFFECT Euro **474**

METAL

● M79 Aluminium	LME50079
● M73 Titanium	LME50073
● M70 Ghisa	LME50070

GRANITEK
NATURAL GRANITE EFFECT Euro **451**

MATT

○ G68 Bianco	LGE50068
● G48 Cemento	LGE50048
● G43 Tortora	LGE50043
● G40 Nero	LGE50040

CLASSIC

● G62 Bianco Antico	LGE50062
● G59 Antracite	LGE50059
● G54 Nero Pietra	LGE50054
● G52 Bianco Pietra	LGE50052
● G51 Avena	LGE50051

ACCESSORI CONSIGLIATI



EGO 480



Lavello 1 vasca con gocciolatoio

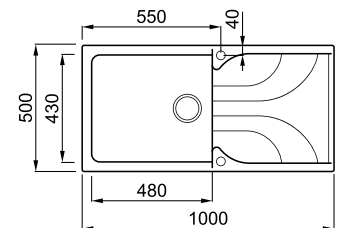

Disegno Tecnico approfondito: QR code a pag. 119



CARATTERISTICHE

Dimensioni (mm)	1000 x 500
Base (mm)	600
Foro da incasso (mm)	980 x 485
Profondità Vasca (mm)	210
Orientamento	Reversibile

MATERIALI E COLORI

GRANITEK
NATURAL GRANITE EFFECT Euro **468**

METAL

● M79 Aluminium	LME48079
● M73 Titanium	LME48073
● M70 Ghisa	LME48070

GRANITEK
NATURAL GRANITE EFFECT Euro **445**

MATT

○ G68 Bianco	LGE48068
● G48 Cemento	LGE48048
● G43 Tortora	LGE48043
● G40 Nero	LGE48040

CLASSIC

● G62 Bianco Antico	LGE48062
● G59 Antracite	LGE48059
● G54 Nero Pietra	LGE48054
● G52 Bianco Pietra	LGE48052
● G51 Avena	LGE48051

ACCESSORI CONSIGLIATI

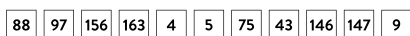

88 Element Tagliere
Sliding 50cm



ATH010GR
Euro **147**
Pag. 168

156 Element Drainer Flex 500

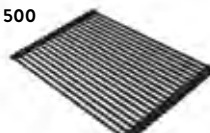

ARS023BK
Euro **88**
Pag. 173

163 Element Cover
Piletta Materica



AKCP1240
Euro **42**
Pag. 174

EGO 475



Lavello 1 vasca ½ con gocciolatoio

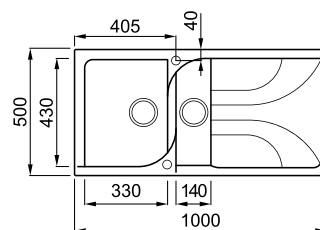

MATERIALI E COLORI

GRANITEK
NATURAL GRANITE EFFECT

Euro **435**

METAL

- M79 Aluminium LME47579
- M73 Titanium LME47573
- M70 Ghisa LME47570

GRANITEK
NATURAL GRANITE EFFECT

Euro **413**

MATT

- G68 Bianco LGE47568
- G48 Cemento LGE47548
- G43 Tortora LGE47543
- G40 Nero LGE47540

CLASSIC

- G62 Bianco Antico LGE47562
- G59 Antracite LGE47559
- G54 Nero Pietra LGE47554
- G52 Bianco Pietra LGE47552
- G51 Avena LGE47551

CARATTERISTICHE

Dimensioni (mm)	1000 x 500
Base (mm)	600
Foro da incasso (mm)	980 x 485
Profondità Vasca 1 (mm)	210
Profondità Vasca 2 (mm)	155
Orientamento	Reversibile

ACCESSORI CONSIGLIATI

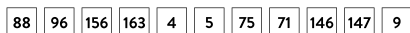

Disegno Tecnico approfondito: QR code a pag. 119

EGO 450



Lavello 2 vasche

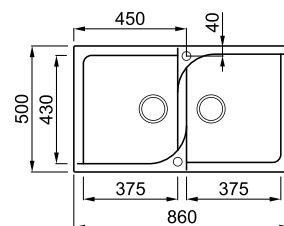

MATERIALI E COLORI

GRANITEK
NATURAL GRANITE EFFECT

Euro **435**

METAL

- M79 Aluminium LME45079
- M73 Titanium LME45073
- M70 Ghisa LME45070

GRANITEK
NATURAL GRANITE EFFECT

Euro **413**

MATT

- G68 Bianco LGE45068
- G48 Cemento LGE45048
- G43 Tortora LGE45043
- G40 Nero LGE45040

CLASSIC

- G62 Bianco Antico LGE45062
- G59 Antracite LGE45059
- G54 Nero Pietra LGE45054
- G52 Bianco Pietra LGE45052
- G51 Avena LGE45051

CARATTERISTICHE

Dimensioni (mm)	860 x 500
Base (mm)	900
Foro da incasso (mm)	840 x 485
Profondità Vasca 1 (mm)	210
Profondità Vasca 2 (mm)	210
Orientamento	Reversibile

ACCESSORI CONSIGLIATI

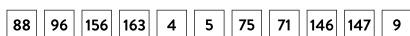

Disegno Tecnico approfondito: QR code a pag. 119

96 Element Pop-Up
Push Control 2 vie



ASP23002
Euro **71**
Pag. 171

5 Colander



AVI03001
Euro **126**
Pag. 178

151 Crema Smacchiante Deep
Clean Lavelli Granitek



DLC01601
Pag. 175

EGO 400



CARATTERISTICHE

Dimensioni (mm)	860 x 500
Base (mm)	450
Foro da incasso (mm)	840 x 490
Profondità Vasca (mm)	210
Orientamento	Reversibile

ACCESSORI CONSIGLIATI



Lavello 1 vasca con gocciolatoio

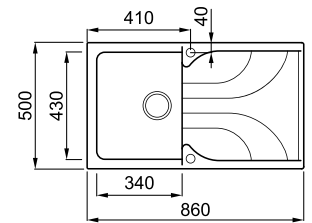

Disegno Tecnico approfondito: QR code a pag. 119

MATERIALI E COLORI

GRANITEK
NATURAL GRANITE EFFECT Euro **408**

METAL

● M79 Aluminium	LME40079
● M73 Titanium	LME40073
● M70 Ghisa	LME40070

GRANITEK
NATURAL GRANITE EFFECT Euro **390**

MATT

○ G68 Bianco	LGE40068
● G48 Cemento	LGE40048
● G43 Tortora	LGE40043
● G40 Nero	LGE40040

CLASSIC

● G62 Bianco Antico	LGE40062
● G59 Antracite	LGE40059
● G54 Nero Pietra	LGE40054
● G52 Bianco Pietra	LGE40052
● G51 Avena	LGE40051

EGO ESA



CARATTERISTICHE

Dimensioni (mm)	1000 x 500
Base (mm)	800
Foro da incasso (mm)	da disegno
Profondità Vasca 1 (mm)	210
Profondità Vasca 2 (mm)	120
Orientamento	Non reversibile

ACCESSORI CONSIGLIATI

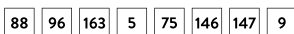

Lavello 2 vasche con gocciolatoio

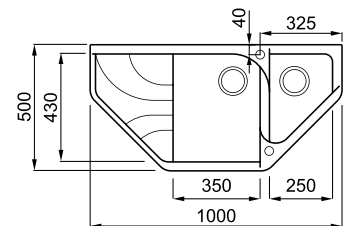

Disegno Tecnico approfondito: QR code a pag. 119

MATERIALI E COLORI

GRANITEK
NATURAL GRANITE EFFECT Euro **454**

METAL

● M79 Aluminium	LMEESA79
● M73 Titanium	LMEESA73
● M70 Ghisa	LMEESA70

GRANITEK
NATURAL GRANITE EFFECT Euro **435**

MATT

○ G68 Bianco	LGEESA68
● G43 Tortora	LGEESA43
● G40 Nero	LGEESA40

CLASSIC

● G62 Bianco Antico	LGEESA62
● G59 Antracite	LGEESA59
● G51 Avena	LGEESA51

88 Element Tagliere
Sliding 50cm



ATH0100L
Euro **147**
Pag. 168

5 Colander



AVI03001
Euro **126**
Pag. 178

146 Cover piletta



ACPM1000
Euro **21**
Pag. 179

EGO CORNER

Lavello angolare 1 vasca ½ con gocciolatoio

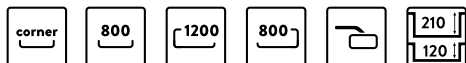
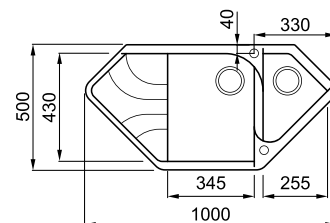

MATERIALI E COLORI

GRANITEK
NATURAL GRANITE EFFECT

Euro **454**

METAL

- M79 Aluminium LMECOR79
- M73 Titanium LMECOR73
- M70 Ghisa LMECOR70

GRANITEK
NATURAL GRANITE EFFECT

Euro **435**

MATT

- G68 Bianco LGECOR68
- G43 Tortora LGECOR43
- G40 Nero LGECOR40

CLASSIC

- G62 Bianco Antico LGECOR62
- G59 Antracite LGECOR59
- G51 Avena LGECOR51

CARATTERISTICHE

Dimensioni (mm) **1000 x 500**
 Base (mm) **Angolare**
 - se montaggio lineare **800**
 Foro da incasso (mm) **da disegno**
 Profondità Vasca 1 (mm) **210**
 Profondità Vasca 2 (mm) **120**
 Orientamento **Non reversibile**

ACCESSORI CONSIGLIATI

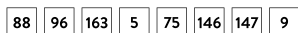

Disegno Tecnico approfondito: QR code a pag. 119

EGO ROUND

Lavello 1 vasca

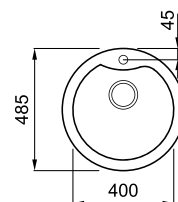

MATERIALI E COLORI

GRANITEK
NATURAL GRANITE EFFECT

Euro **316**

METAL

- M79 Aluminium LMEROU79
- M73 Titanium LMEROU73
- M70 Ghisa LMEROU70

ACCESSORIO CONSIGLIATO

TAGLIERE IN LEGNO ROUND

ATL02300 Euro **58**



GRANITEK
NATURAL GRANITE EFFECT

Euro **300**

MATT

- G68 Bianco LGEROU68
- G43 Tortora LGEROU43
- G40 Nero LGEROU40

CLASSIC

- G62 Bianco Antico LGEROU62
- G59 Antracite LGEROU59
- G51 Avena LGEROU51

CARATTERISTICHE

Dimensioni (mm) **ø 485**
 Base (mm) **500**
 Foro da incasso (mm) **ø 465**
 Profondità Vasca (mm) **210**
 Orientamento **Non reversibile**

ACCESSORI CONSIGLIATI

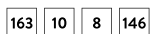

Disegno Tecnico approfondito: QR code a pag. 119

10 Tagliere in legno Round



ATL02300
Euro **58**
Pag. 178

8 Cestello Ego Round



ACI02300
Euro **52**
Pag. 178

151 Crema Smacchiante Deep Clean Lavelli Granitek



DLC01601
Pag. 175





COLLEZIONE

TEKNO

LINEE CHE PERSONALIZZANO
LA TUA CUCINA

COLLEZIONE

TEKNO

Una collezione di lavelli dal design moderno ed accattivante dalle linee marcate che ne conferiscono una perfetta geometria. Ogni modello è combinabile con numerosi accessori e molteplici colorazioni.



SOPRATOP



Lavello Tekno 475 G40 Nero con miscelatore Ares G40 Nero

800

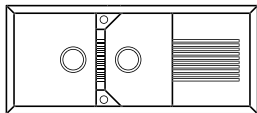

TEKNO 500
PAG. 128

1000

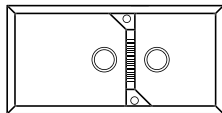

TEKNO 490
PAG. 128

600

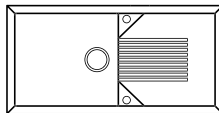

TEKNO 480
PAG. 129

600

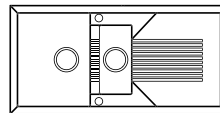

TEKNO 475
PAG. 129

900

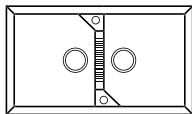

TEKNO 450
PAG. 130

500

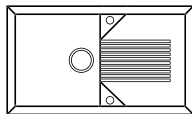

TEKNO 400
PAG. 130



DISEGNI TECNICI
APPROFONDITI
LINEA TEKNO

Corredo del lavello: Sifone salvaspazio, pilette e ganci.

GRANITEK
NATURAL GRANITE EFFECT

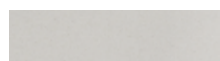

M79 Aluminium



M73 Titanium



G68 Bianco



G48 Cemento

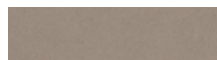

G43 Tortora



G40 Nero



G59 Antracite



G51 Avena



VASCA XL

Vasca dallo spazio ampio e maggiorato per ospitare utensili di grandi dimensioni e facilitare le operazioni di utilizzo.



**DESIGN CON
PERSONALITÀ**

Le linee marcate del gocciolatoio caratterizzano e danno personalità ai lavelli della linea Tekno, dove si incontrano perfette geometrie ed elevate funzionalità.



ACCESSORI ELEMENT

Tagliere, drainer flex e pop up permettono di completare il lavello a proprio gusto e piacimento, rendendo le operazioni di preparazione del cibo più facili e pratiche.



**ACCESSORIO ELEMENT
COVER MATERICA**

Quel tocco di classe in più. La cover piletta materica è realizzata negli stessi materiali e colori del lavello, esaltando gli accordi estetici tra gli elementi e valorizzando l'ambiente circostante.

TEKNO 500



Lavello 2 vasche con gocciolatoio

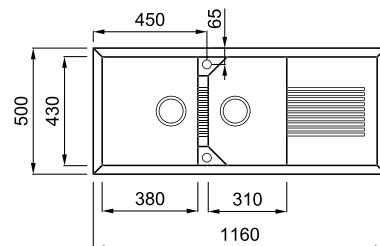

Disegno Tecnico approfondito: QR code a pag. 127



CARATTERISTICHE

Dimensioni (mm)	1160 x 500
Base (mm)	800
Foro da incasso (mm)	1140 x 480
Profondità Vasca 1 (mm)	225
Profondità Vasca 2 (mm)	200
Orientamento	Reversibile

MATERIALI E COLORI

GRANITEK NATURAL GRANITE EFFECT	Euro 518
METAL	
● M79 Aluminium	LMT50079
● M73 Titanium	LMT50073

GRANITEK NATURAL GRANITE EFFECT	Euro 491
MATT	
○ G68 Bianco	LGT50068
● G48 Cemento	LGT50048
● G43 Tortora	LGT50043
● G40 Nero	LGT50040
CLASSIC	
● G59 Antracite	LGT50059
● G51 Avena	LGT50051

ACCESSORI CONSIGLIATI

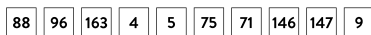

TEKNO 490



Lavello 2 vasche

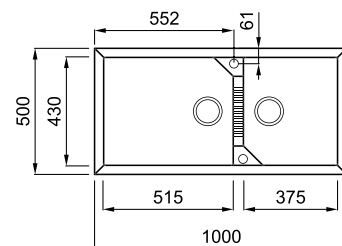

Disegno Tecnico approfondito: QR code a pag. 127

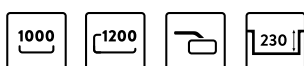

CARATTERISTICHE

Dimensioni (mm)	1000 x 500
Base (mm)	1000
- se inizio composizione	1200
Foro da incasso (mm)	980 x 490
Profondità Vasca 1 (mm)	230
Profondità Vasca 2 (mm)	230
Orientamento	Reversibile

MATERIALI E COLORI

GRANITEK NATURAL GRANITE EFFECT	Euro 508
METAL	
● M79 Aluminium	LMT49079
● M73 Titanium	LMT49073

GRANITEK NATURAL GRANITE EFFECT	Euro 485
MATT	
○ G68 Bianco	LGT49068
● G48 Cemento	LGT49048
● G43 Tortora	LGT49043
● G40 Nero	LGT49040
CLASSIC	
● G59 Antracite	LGT49059
● G51 Avena	LGT49051

ACCESSORI CONSIGLIATI

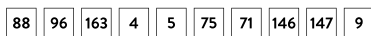

88 Element Tagliere
Sliding 50cm



ATH010GR
Euro **147**
Pag. 168

97 Element Pop-Up
Push Control 2 Vie



ASP23002BK
Euro **130**
Pag. 171

163 Element Cover
Piletta Materica



AKCP1248
Euro **42**
Pag. 174

TEKNO 480



CARATTERISTICHE

Dimensioni (mm)	1000 x 500
Base (mm)	600
Foro da incasso (mm)	980 x 490
Profondità Vasca (mm)	225
Orientamento	Reversibile

ACCESSORI CONSIGLIATI



Lavello 1 vasca con gocciolatoio

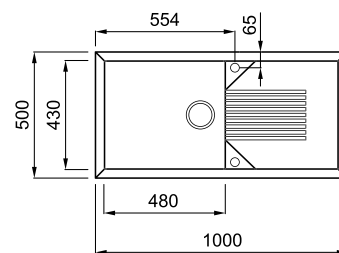

Disegno Tecnico approfondito: QR code a pag. 127

MATERIALI E COLORI

GRANITEK
NATURAL GRANITE EFFECT

Euro **498**

METAL

- M79 Aluminium LMT48079
- M73 Titanium LMT48073

GRANITEK
NATURAL GRANITE EFFECT

Euro **478**

MATT

- G68 Bianco LGT48068
- G48 Cemento LGT48048
- G43 Tortora LGT48043
- G40 Nero LGT48040

CLASSIC

- G59 Antracite LGT48059
- G51 Avena LGT48051

TEKNO 475

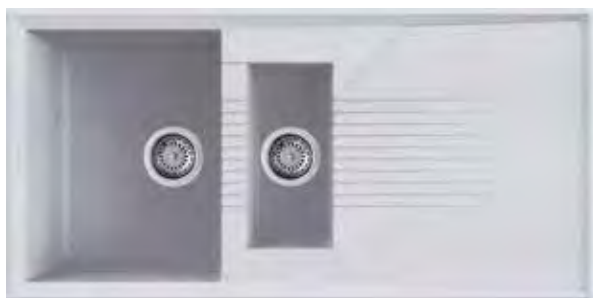

CARATTERISTICHE

Dimensioni (mm)	1000 x 500
Base (mm)	600
Foro da incasso (mm)	980 x 490
Profondità Vasca 1 (mm)	215
Profondità Vasca 2 (mm)	160
Orientamento	Reversibile

ACCESSORI CONSIGLIATI

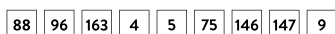

Lavello 1 vasca 1/2 con gocciolatoio

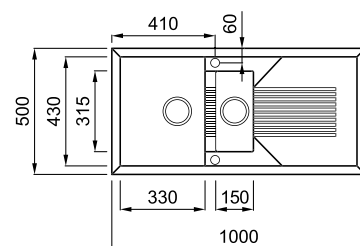

Disegno Tecnico approfondito: QR code a pag. 127

MATERIALI E COLORI

GRANITEK
NATURAL GRANITE EFFECT

Euro **505**

METAL

- M79 Aluminium LMT47579
- M73 Titanium LMT47573

GRANITEK
NATURAL GRANITE EFFECT

Euro **482**

MATT

- G68 Bianco LGT47568
- G48 Cemento LGT47548
- G43 Tortora LGT47543
- G40 Nero LGT47540

CLASSIC

- G59 Antracite LGT47559
- G51 Avena LGT47551

9 Scolapiatti

ADI01300
Euro **48**
Pag. 179



71 Bottom Grid S

AGB01306
Euro **78**
Pag. 179



Escluso Tekno 475

160 Spray Detergente
Sgrassante Daily Clean

DLL01601
Pag. 175



TEKNO 450



Lavello 2 vasche

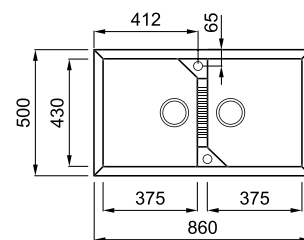

Disegno Tecnico approfondito: QR code a pag. 127



CARATTERISTICHE

Dimensioni (mm)	860 x 500
Base (mm)	900
Foro da incasso (mm)	840 x 480
Profondità Vasca 1 (mm)	230
Profondità Vasca 2 (mm)	230
Orientamento	Reversibile

ACCESSORI CONSIGLIATI



MATERIALI E COLORI

GRANITEK NATURAL GRANITE EFFECT	Euro 460
METAL	
● M79 Aluminium	LMT45079
● M73 Titanium	LMT45073

GRANITEK NATURAL GRANITE EFFECT	Euro 438
MATT	
○ G68 Bianco	LGT45068
● G48 Cemento	LGT45048
● G43 Tortora	LGT45043
● G40 Nero	LGT45040
CLASSIC	
● G59 Antracite	LGT45059
● G51 Avena	LGT45051

TEKNO 400



Lavello 1 vasca con gocciolatoio

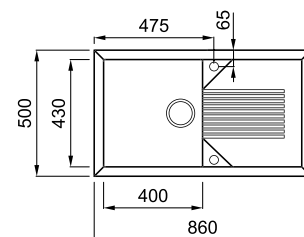

Disegno Tecnico approfondito: QR code a pag. 127

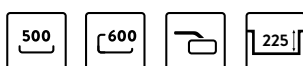

CARATTERISTICHE

Dimensioni (mm)	860 x 500
Base (mm)	500
- se inizio composizione	600
Foro da incasso (mm)	840 x 480
Profondità Vasca (mm)	225
Orientamento	Reversibile

ACCESSORI CONSIGLIATI

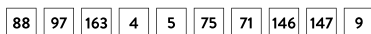

MATERIALI E COLORI

GRANITEK NATURAL GRANITE EFFECT	Euro 437
METAL	
● M79 Aluminium	LMT40079
● M73 Titanium	LMT40073

GRANITEK NATURAL GRANITE EFFECT	Euro 417
MATT	
○ G68 Bianco	LGT40068
● G48 Cemento	LGT40048
● G43 Tortora	LGT40043
● G40 Nero	LGT40040
CLASSIC	
● G59 Antracite	LGT40059
● G51 Avena	LGT40051

88 Element Tagliere Sliding 50cm



ATH010QU
Euro **147**
Pag. 168

5 Colander



AVI03001
Euro **126**
Pag. 178

146 Cover piletta



ACPM1000
Euro **21**
Pag. 179



97 Element Pop-Up
Push Control



ASP13002
Euro **37**
Pag. 171

75 Cestello



ACI01307
Euro **101**
Pag. 178

158 Spray Anticalcare
Disincrostante Daily Clean



DLA01601
Pag. 176





COLLEZIONE

EASY

PRISMA-CLEAN LAVELLI
DAL BORDO PRISMATICO

COLLEZIONE

EASY

Un progetto essenziale, unico, senza tempo. Un prodotto unico dallo spiccato carattere innovativo che armonizza una funzionalità estrema con la capacità di poter “modellarsi” alle esigenze di chi lo utilizza fino a poter “scomparere” del tutto.



SOPRATOP



Lavello Easy 300 G68 Bianco con miscelatore Bridge Cromato

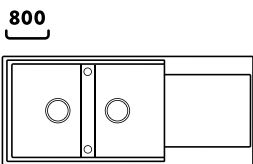

EASY 500
PAG. 136

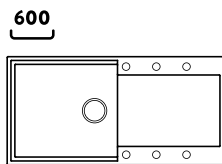

EASY 480
PAG. 136

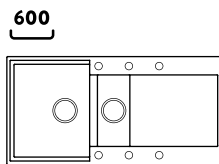

EASY 475
PAG. 137

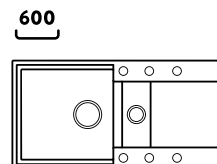

EASY 425
PAG. 137

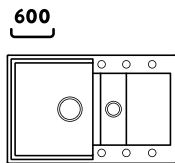

EASY 325
PAG. 138

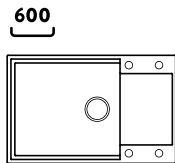

EASY 310
PAG. 138

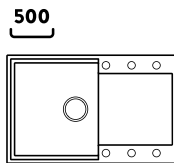

EASY 300
PAG. 139

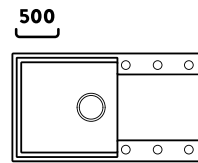

EASY 290
PAG. 139

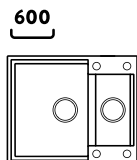

EASY 150
PAG. 140

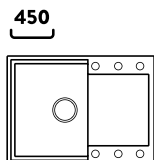

EASY 135
PAG. 140

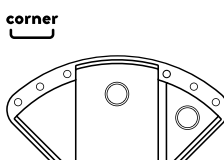

EASY CORNER
PAG. 141

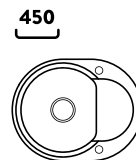

EASY ROUND 600
PAG. 141

Corredo del lavello: Sifone salvaspazio, pilette e ganci.

GRANITEK
NATURAL GRANITE EFFECT



M79 Aluminium



M78 Espresso



M73 Titanium



M70 Ghisa



G68 Bianco



G48 Cemento

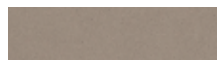

G43 Tortora



G40 Nero



G62 Bianco Antico



G59 Antracite



G51 Avena



DISEGNI TECNICI
APPROFONDITI
LINEA EASY



VASCA XL

Vasca dallo spazio ampio e maggiorato per ospitare utensili di grandi dimensioni e facilitare le operazioni di utilizzo.

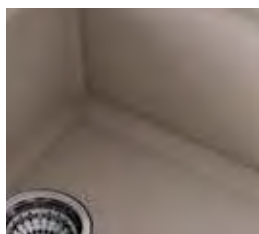

PRISMA CLEAN

Il sistema Prisma-clean sostituisce le classiche raggiature interne con facce prismatiche che ammorbidiscono e facilitano la pulizia delle aree interne della vasca, mantenendo un deciso carattere estetico.



DESIGN ESSENZIALE

Essenzialità e semplicità sono le parole chiave per descrivere il design di Easy, dove il gocciolatoio si caratterizza per le sue linee rette e ben definite.



ACCESSORI ELEMENT

Tagliere, drainer flex e pop up permettono di completare il lavello a proprio gusto e piacimento, rendendo le operazioni di preparazione del cibo più facili e pratiche.

EASY 500



Lavello 2 vasche con gocciolatoio

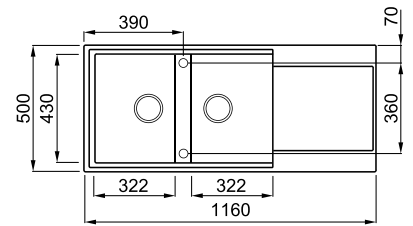

Disegno Tecnico approfondito: QR code a pag. 135



CARATTERISTICHE

Dimensioni (mm)	1160 x 500
Base (mm)	800
Foro da incasso (mm)	1140 x 480
Profondità Vasca 1 (mm)	200
Profondità Vasca 2 (mm)	200
Orientamento	Reversibile

MATERIALI E COLORI

GRANITEK NATURAL GRANITE EFFECT	Euro 433
METAL	
● M79 Aluminium	LMY50079
● M78 Espresso	LMY50078
● M73 Titanium	LMY50073
● M70 Ghisa	LMY50070

GRANITEK NATURAL GRANITE EFFECT	Euro 412
MATT	
○ G68 Bianco	LGY50068
● G48 Cemento	LGY50048
● G43 Tortora	LGY50043
● G40 Nero	LGY50040
CLASSIC	
● G62 Bianco Antico	LGY50062
● G59 Antracite	LGY50059
● G51 Avena	LGY50051

ACCESSORI CONSIGLIATI



EASY 480

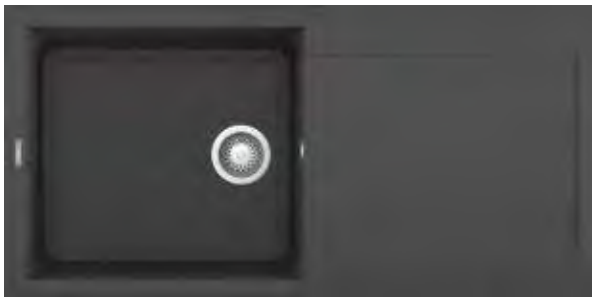

Lavello 1 vasca con gocciolatoio

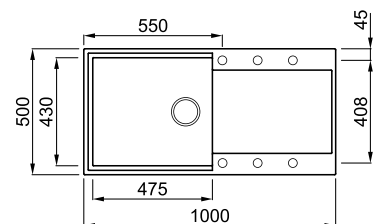

Disegno Tecnico approfondito: QR code a pag. 135



CARATTERISTICHE

Dimensioni (mm)	1000 x 500
Base (mm)	600
Foro da incasso (mm)	980 x 480
Profondità Vasca (mm)	200
Orientamento	Reversibile

MATERIALI E COLORI

GRANITEK NATURAL GRANITE EFFECT	Euro 398
METAL	
● M79 Aluminium	LMY48079
● M78 Espresso	LMY48078
● M73 Titanium	LMY48073
● M70 Ghisa	LMY48070

GRANITEK NATURAL GRANITE EFFECT	Euro 378
MATT	
○ G68 Bianco	LGY48068
● G48 Cemento	LGY48048
● G43 Tortora	LGY48043
● G40 Nero	LGY48040
CLASSIC	
● G62 Bianco Antico	LGY48062
● G59 Antracite	LGY48059
● G51 Avena	LGY48051

ACCESSORI CONSIGLIATI

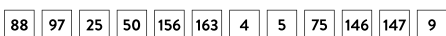

88 Element Tagliere
Sliding 50cm



ATH010OL
Euro **147**
Pag. 168

Escluso Easy 425

156 Element Drainer Flex
500 - 440

157

Euro
ARS023BK **88**
ARS013BK **80**
Pag. 173-174

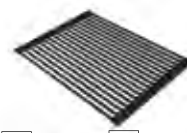

156 **157**
Escluso E425 E425

163 Element Cover
Piletta Materica



AKCP1296
Euro **42**
Pag. 174

EASY 475

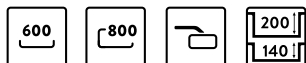

CARATTERISTICHE

Dimensioni (mm)	1000 x 500
Base (mm)	600
- se inizio composizione	800
Foro da incasso (mm)	980 x 480
Profondità Vasca 1 (mm)	200
Profondità Vasca 2 (mm)	140
Orientamento	Reversibile

ACCESSORI CONSIGLIATI

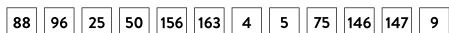

Lavello 1 vasca ½ con gocciolatoio

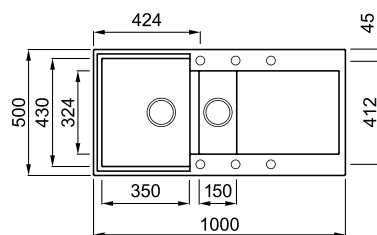

Disegno Tecnico approfondito: QR code a pag. 135

MATERIALI E COLORI

GRANITEK
NATURAL GRANITE EFFECT

Euro **431**

METAL

	M79 Aluminium	LMY47579
	M78 Espresso	LMY47578
	M73 Titanium	LMY47573
	M70 Ghisa	LMY47570

GRANITEK
NATURAL GRANITE EFFECT

Euro **410**

MATT

	G68 Bianco	LGY47568
	G48 Cemento	LGY47548
	G43 Tortora	LGY47543
	G40 Nero	LGY47540

CLASSIC

	G62 Bianco Antico	LGY47562
	G59 Antracite	LGY47559
	G51 Avena	LGY47551

EASY 425



CARATTERISTICHE

Dimensioni (mm)	860 x 435
Base (mm)	600
Foro da incasso (mm)	840 x 415
Profondità Vasca 1 (mm)	210
Profondità Vasca 2 (mm)	120
Orientamento	Reversibile

ACCESSORI CONSIGLIATI

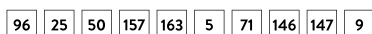

Lavello 1 vasca ½ con gocciolatoio

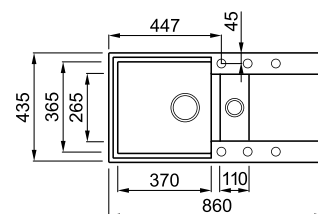

Disegno Tecnico approfondito: QR code a pag. 135

MATERIALI E COLORI

GRANITEK
NATURAL GRANITE EFFECT

Euro **344**

METAL

	M79 Aluminium	LMY42579
	M78 Espresso	LMY42578
	M73 Titanium	LMY42573
	M70 Ghisa	LMY42570

GRANITEK
NATURAL GRANITE EFFECT

Euro **328**

MATT

	G68 Bianco	LGY42568
	G48 Cemento	LGY42548
	G43 Tortora	LGY42543
	G40 Nero	LGY42540

CLASSIC

	G62 Bianco Antico	LGY42562
	G59 Antracite	LGY42559
	G51 Avena	LGY42551

96 Element Pop-Up
Push Control 2 vie



ASP23002
Euro **71**
Pag. 171

5 Colander



AVI03001
Euro **126**
Pag. 178

151 Crema Smacchiante Deep
Clean Lavelli Granitek



DLC01601
Pag. 175

EASY 325



Lavello 1 vasca 1/2 con gocciolatoio

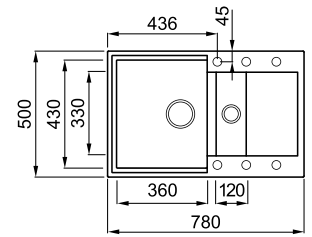

Disegno Tecnico approfondito: QR code a pag. 135



CARATTERISTICHE

Dimensioni (mm)	780 x 500
Base (mm)	600
Foro da incasso (mm)	760 x 480
Profondità Vasca 1 (mm)	220
Profondità Vasca 2 (mm)	120
Orientamento	Reversibile

MATERIALI E COLORI

GRANITEK NATURAL GRANITE EFFECT Euro **344**

METAL

● M79 Aluminium	LMY32579
● M78 Espresso	LMY32578
● M73 Titanium	LMY32573
● M70 Ghisa	LMY32570

GRANITEK NATURAL GRANITE EFFECT Euro **328**

MATT

○ G68 Bianco	LGY32568
● G48 Cemento	LGY32548
● G43 Tortora	LGY32543
● G40 Nero	LGY32540

CLASSIC

● G62 Bianco Antico	LGY32562
● G59 Antracite	LGY32559
● G51 Avena	LGY32551

ACCESSORI CONSIGLIATI

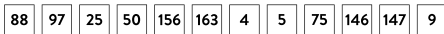

EASY 310



Lavello 1 vasca con gocciolatoio

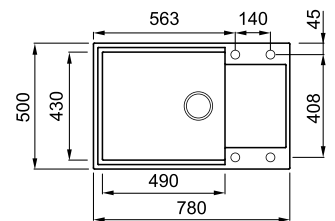

Disegno Tecnico approfondito: QR code a pag. 135



CARATTERISTICHE

Dimensioni (mm)	780 x 500
Base (mm)	600
- se inizio composizione	800
Foro da incasso (mm)	760 x 480
Profondità Vasca (mm)	200
Orientamento	Reversibile

MATERIALI E COLORI

GRANITEK NATURAL GRANITE EFFECT Euro **340**

METAL

● M79 Aluminium	LMY31079
● M78 Espresso	LMY31078
● M73 Titanium	LMY31073
● M70 Ghisa	LMY31070

GRANITEK NATURAL GRANITE EFFECT Euro **323**

MATT

○ G68 Bianco	LGY31068
● G48 Cemento	LGY31048
● G43 Tortora	LGY31043
● G40 Nero	LGY31040

CLASSIC

● G62 Bianco Antico	LGY31062
● G59 Antracite	LGY31059
● G51 Avena	LGY31051

ACCESSORI CONSIGLIATI

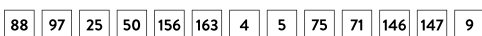

88 Element Tagliere Sliding 50cm



ATH010OL
Euro **147**
Pag. 168

Escluso Easy 290

156 Element Drainer Flex 500 - 440

157

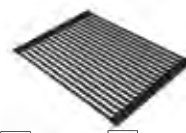

Euro
ARS023BK **88**
ARS013BK **80**
Pag. 173-174

156

Escluso E290

157

E290

146 Cover piletta



ACPM1000
Euro **21**
Pag. 179

EASY 300



CARATTERISTICHE

Dimensioni (mm)	790 x 500
Base (mm)	500
- se inizio composizione	600
Foro da incasso (mm)	770 x 480
Profondità Vasca (mm)	220
Orientamento	Reversibile

ACCESSORI CONSIGLIATI

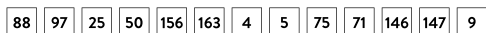

MATERIALI E COLORI

GRANITEK
NATURAL GRANITE EFFECT

Euro **328**

METAL

	M79 Aluminium	LMY30079
	M78 Espresso	LMY30078
	M73 Titanium	LMY30073
	M70 Ghisa	LMY30070

Lavello 1 vasca con gocciolatoio

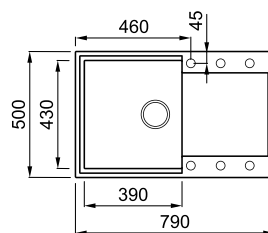

Disegno Tecnico approfondito: QR code a pag. 135

GRANITEK
NATURAL GRANITE EFFECT

Euro **312**

MATT

	G68 Bianco	LGY30068
	G48 Cemento	LGY30048
	G43 Tortora	LGY30043
	G40 Nero	LGY30040

CLASSIC

	G62 Bianco Antico	LGY30062
	G59 Antracite	LGY30059
	G51 Avena	LGY30051

EASY 290



CARATTERISTICHE

Dimensioni (mm)	780 x 435
Base (mm)	500
- se inizio composizione	600
Foro da incasso (mm)	760 x 415
Profondità Vasca (mm)	210
Orientamento	Reversibile

ACCESSORI CONSIGLIATI

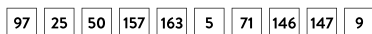

MATERIALI E COLORI

GRANITEK
NATURAL GRANITE EFFECT

Euro **328**

METAL

	M79 Aluminium	LMY29079
	M78 Espresso	LMY29078
	M73 Titanium	LMY29073
	M70 Ghisa	LMY29070

Lavello 1 vasca con gocciolatoio

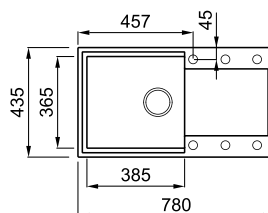

Disegno Tecnico approfondito: QR code a pag. 135

GRANITEK
NATURAL GRANITE EFFECT

Euro **312**

MATT

	G68 Bianco	LGY29068
	G48 Cemento	LGY29048
	G43 Tortora	LGY29043
	G40 Nero	LGY29040

CLASSIC

	G62 Bianco Antico	LGY29062
	G59 Antracite	LGY29059
	G51 Avena	LGY29051

25 Element Dispenser
Sapone Tondo



ADI02300
Euro **42**
Pag. 172

75 Cestello



ACI01307
Euro **101**
Pag. 178

Escluso Easy 290

160 Spray Detergente
Sgrassante Daily Clean



DLL01601
Pag. 175

EASY 150

Lavello 1 vasca 1/2

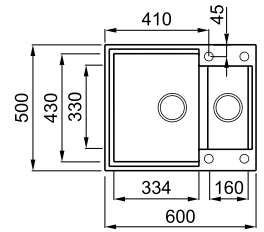

Disegno Tecnico approfondito: QR code a pag. 135

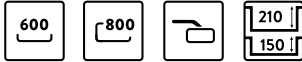

CARATTERISTICHE

Dimensioni (mm)	600 x 500
Base (mm)	600
- se inizio composizione	800
Foro da incasso (mm)	580 x 480
Profondità Vasca 1 (mm)	210
Profondità Vasca 2 (mm)	150
Orientamento	Reversibile

ACCESSORI CONSIGLIATI

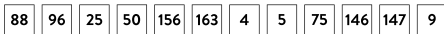

MATERIALI E COLORI

GRANITEK
NATURAL GRANITE EFFECT

Euro **317**

METAL

● M79 Aluminium	LMY15079
● M78 Espresso	LMY15078
● M73 Titanium	LMY15073
● M70 Ghisa	LMY15070

GRANITEK
NATURAL GRANITE EFFECT

Euro **302**

MATT

○ G68 Bianco	LGY15068
● G48 Cemento	LGY15048
● G43 Tortora	LGY15043
● G40 Nero	LGY15040

CLASSIC

● G62 Bianco Antico	LGY15062
● G59 Antracite	LGY15059
● G51 Avena	LGY15051

EASY 135

Lavello 1 vasca con gocciolatoio

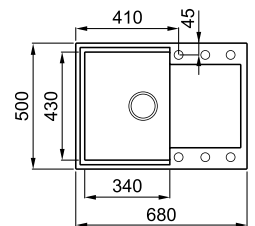
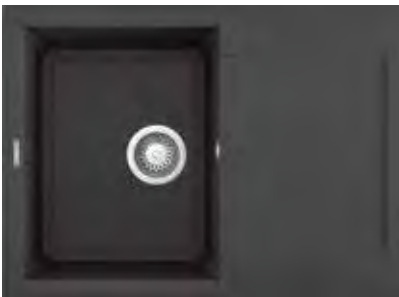

Disegno Tecnico approfondito: QR code a pag. 135



CARATTERISTICHE

Dimensioni (mm)	680 x 500
Base (mm)	450
- se inizio composizione	600
Foro da incasso (mm)	660 x 480
Profondità Vasca (mm)	210
Orientamento	Reversibile

ACCESSORI CONSIGLIATI

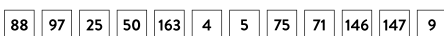

MATERIALI E COLORI

GRANITEK
NATURAL GRANITE EFFECT

Euro **281**

METAL

● M79 Aluminium	LMY13579
● M78 Espresso	LMY13578
● M73 Titanium	LMY13573
● M70 Ghisa	LMY13570

GRANITEK
NATURAL GRANITE EFFECT

Euro **267**

MATT

○ G68 Bianco	LGY13568
● G48 Cemento	LGY13548
● G43 Tortora	LGY13543
● G40 Nero	LGY13540

CLASSIC

● G62 Bianco Antico	LGY13562
● G59 Antracite	LGY13559
● G51 Avena	LGY13551

88 Element Tagliere Sliding 50cm



ATH010QU
Euro **147**
Pag. 168

156 Element Drainer Flex 500

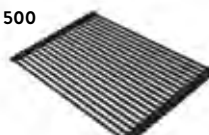

ARS023BK
Euro **88**
Pag. 173

Solo Easy 150

163 Element Cover Piletta Materica



AKCP1295
Euro **42**
Pag. 174

EASY CORNER



CARATTERISTICHE

Dimensioni (mm) **1057 x 575**
 Base (mm) **Angolare**
 - Top minimo 650 mm **800**
 Foro da incasso (mm) **da disegno**
 Profondità Vasca 1 (mm) **210**
 Profondità Vasca 2 (mm) **150**
 Orientamento **Non reversibile**

ACCESSORI CONSIGLIATI

96 25 50 163 5 63 75 71 146 147 9

Lavello angolare 1 vasca 1/2 con gocciolatoio

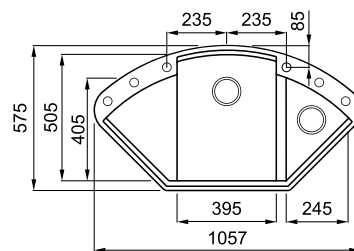

Disegno Tecnico approfondito: QR code a pag. 135

MATERIALI E COLORI

GRANITEK
 NATURAL GRANITE EFFECT

Euro **454**

METAL

- M79 Aluminium LMYCOR79
- M78 Espresso LMYCOR78
- M73 Titanium LMYCOR73
- M70 Ghisa LMYCOR70

ACCESSORIO CONSIGLIATO

COLANDER EASY CORNER

AVI03307 Euro **116**



GRANITEK
 NATURAL GRANITE EFFECT

Euro **435**

MATT

- G68 Bianco LGYCOR68
- G48 Cemento LGYCOR48
- G43 Tortora LGYCOR43
- G40 Nero LGYCOR40

CLASSIC

- G62 Bianco Antico LGYCOR62
- G59 Antracite LGYCOR59
- G51 Avena LGYCOR51

EASY ROUND 600



CARATTERISTICHE

Dimensioni (mm) **600 x 470**
 Base (mm) **450**
 Foro da incasso (mm) **da disegno**
 Profondità Vasca (mm) **200**
 Orientamento **Reversibile**

ACCESSORI CONSIGLIATI

97 163 15 146 147

Lavello 1 vasca con gocciolatoio

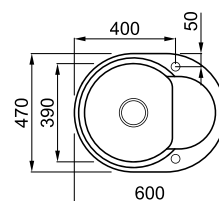

Disegno Tecnico approfondito: QR code a pag. 135

MATERIALI E COLORI

GRANITEK
 NATURAL GRANITE EFFECT

Euro **270**

METAL

- M79 Aluminium LMYR6079
- M78 Espresso LMYR6078
- M73 Titanium LMYR6073
- M70 Ghisa LMYR6070

GRANITEK
 NATURAL GRANITE EFFECT

Euro **256**

MATT

- G68 Bianco LGYR6068
- G48 Cemento LGYR6048
- G43 Tortora LGYR6043
- G40 Nero LGYR6040

CLASSIC

- G62 Bianco Antico LGYR6062
- G59 Antracite LGYR6059
- G51 Avena LGYR6051

15 Cestello Round

ACI02301
 Euro **71**
 Pag. 178



63 Colander Easy Corner

AVI03307
 Euro **116**
 Pag. 178



Solo Easy Corner

158 Spray Anticalcare
 Disincrostante Daily Clean

DLA01601
 Pag. 176







COLLEZIONE

FOX

MODELLI PER SPAZI VERSATILI

COLLEZIONE

FOX

Una collezione di lavelli molto versatile.

Si adatta perfettamente ad ogni tipologia di spazio a disposizione sul top da cucina.

Ogni modello è combinabile con numerosi accessori e molteplici colorazioni.



SOPRATOP



Lavello Fox 450 G59 Antracite con miscelatore Neva Inox

900

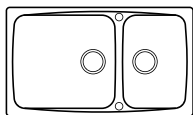

FOX 450
PAG. 146

900

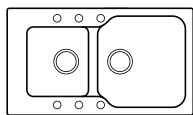

FOX 430
PAG. 146

900

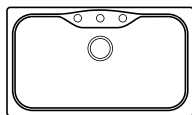

FOX 360
PAG. 147

800

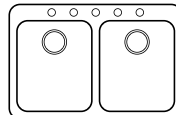

FOX 340
PAG. 147

800

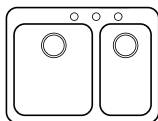

FOX 330
PAG. 148

600

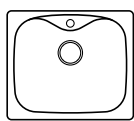

FOX 200
PAG. 148

600

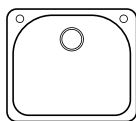

FOX 180
PAG. 149

450

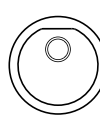

FOX ROUND
PAG. 149



DISEGNI TECNICI
APPROFONDITI
LINEA FOX

Corredo del lavello: Sifone salvaspazio, pilette e ganci.

GRANITEK
NATURAL GRANITE EFFECT

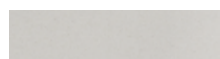

M79 Aluminium



M73 Titanium



G68 Bianco



G40 Nero



G62 Bianco Antico



G59 Antracite



G55 Grigio Pietra



G54 Nero Pietra



G52 Bianco Pietra



G51 Avena



**VASCA CON ANGOLI
ARROTONDATI**

Caratterizzata dagli angoli interni arrotondati delle vasche, la collezione Fox è particolarmente indicata per ambienti cucina classici.



ACCESSORI ELEMENT

Tagliere, drainer flex e pop up permettono di completare il lavello a proprio gusto e piacimento, rendendo le operazioni di preparazione del cibo più facili e pratiche.



**ACCESSORIO KIT
PILETTA OTTONATA**

L'accessorio piletta ottonata conferisce al lavello una sensazione di matericità tattile, nobilitando gli arredi e diventando protagonista di nuove sperimentazioni cromatiche.

FOX 450



Lavello 2 vasche

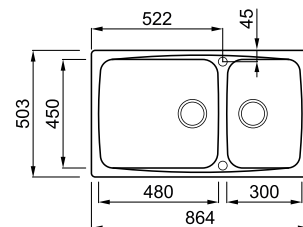

Disegno Tecnico approfondito: QR code a pag. 145



CARATTERISTICHE

Dimensioni (mm)	864 x 503
Base (mm)	900
Foro da incasso (mm)	840 x 490
Profondità Vasca 1 (mm)	225
Profondità Vasca 2 (mm)	225
Orientamento	Reversibile

MATERIALI E COLORI

GRANITEK
NATURAL GRANITE EFFECT

Euro **391**

MATT

- G68 Bianco LGF45068
- G40 Nero LGF45040

CLASSIC

- G62 Bianco Antico LGF45062
- G59 Antracite LGF45059
- G51 Avena LGF45051

ACCESSORI CONSIGLIATI

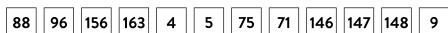

FOX 430



Lavello 2 vasche

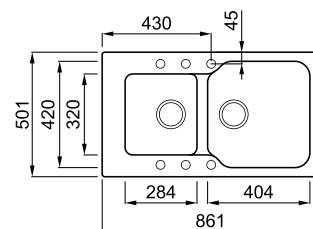

Disegno Tecnico approfondito: QR code a pag. 145



CARATTERISTICHE

Dimensioni (mm)	861 x 501
Base (mm)	900
Foro da incasso (mm)	840 x 490
Profondità Vasca 1 (mm)	200
Profondità Vasca 2 (mm)	200
Orientamento	Reversibile

MATERIALI E COLORI

GRANITEK
NATURAL GRANITE EFFECT

Euro **391**

MATT

- G68 Bianco LGF43068
- G40 Nero LGF43040

CLASSIC

- G62 Bianco Antico LGF43062
- G59 Antracite LGF43059
- G51 Avena LGF43051

ACCESSORI CONSIGLIATI

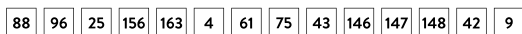

88 Element Tagliere Sliding 50cm



ATH010OL
Euro **147**
Pag. 168

Esclusi Fox 360/340

156 Element Drainer Flex 500

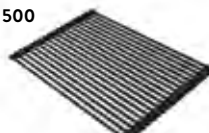

ARS023BK
Euro **88**
Pag. 173

148 Kit Piletta 2 vie e troppopieno ottonati



APM2VSCTPGO
Euro **123**
Pag. 179

FOX 360



Lavello 1 vasca

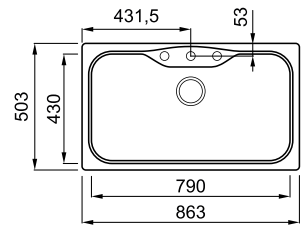

MATERIALI E COLORI

GRANITEK
NATURAL GRANITE EFFECT

Euro **416**

METAL

- M79 Aluminium LMF36079
- M73 Titanium LMF36073

GRANITEK
NATURAL GRANITE EFFECT

Euro **396**

MATT

- G68 Bianco LGF36068
- G40 Nero LGF36040

CARATTERISTICHE

Dimensioni (mm)	863 x 503
Base (mm)	900
Foro da incasso (mm)	840 x 490
Profondità Vasca (mm)	225
Orientamento	Non reversibile

ACCESSORIO CONSIGLIATO

ELEMENT TAGLIERE FOX 360

- Olmo ATH130OL Euro **180**



CLASSIC

- G62 Bianco Antico LGF36062
- G59 Antracite LGF36059
- G55 Grigio Pietra LGF36055
- G54 Nero Pietra LGF36054
- G52 Bianco Pietra LGF36052
- G51 Avena LGF36051

ACCESSORI CONSIGLIATI



FOX 340



Lavello 2 vasche

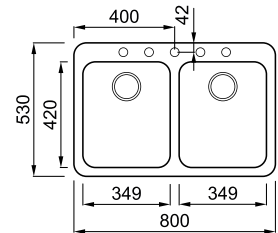

MATERIALI E COLORI

GRANITEK
NATURAL GRANITE EFFECT

Euro **378**

MATT

- G68 Bianco LGF34068BTP
- G40 Nero LGF34040BTP

CLASSIC

- G62 Bianco Antico LGF34062BTP
- G59 Antracite LGF34059BTP
- G51 Avena LGF34051BTP

CARATTERISTICHE

Dimensioni (mm)	800 x 530
Base (mm)	800
Foro da incasso (mm)	780 x 520 R32
Profondità Vasca 1 (mm)	220
Profondità Vasca 2 (mm)	220
Orientamento	Non reversibile

ACCESSORI CONSIGLIATI

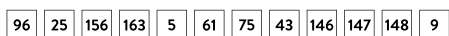

155 Element Tagliere
Fox 360



ATH130OL
Euro **180**
Pag. 168

11 Cestello
Fox 360



ACI03300
Euro **104**
Pag. 178

162 Panni in Microfibra
Fast Clean



DKP01001
Pag. 177

FOX 330

Lavello 2 vasche

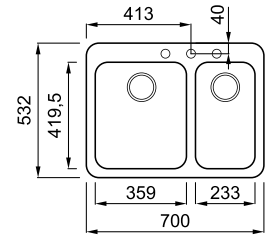

Disegno Tecnico approfondito: QR code a pag. 145



CARATTERISTICHE

Dimensioni (mm)	700 x 532
Base (mm)	800
Foro da incasso (mm)	680 x 520 R32
Profondità Vasca 1 (mm)	230
Profondità Vasca 2 (mm)	200
Orientamento	Non reversibile

MATERIALI E COLORI

GRANITEK
NATURAL GRANITE EFFECT

Euro **360**

MATT

- G68 Bianco LGF33068BTP
- G40 Nero LGF33040BTP

CLASSIC

- G62 Bianco Antico LGF33062BTP
- G59 Antracite LGF33059BTP
- G51 Avena LGF33051BTP

ACCESSORI CONSIGLIATI

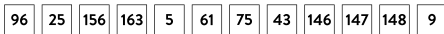

FOX 200

Lavello 1 vasca

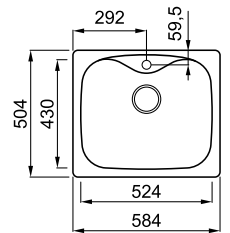

Disegno Tecnico approfondito: QR code a pag. 145



CARATTERISTICHE

Dimensioni (mm)	584 x 504
Base (mm)	600
Foro da incasso (mm)	560 x 480 R32
Profondità Vasca (mm)	230
Orientamento	Non reversibile

MATERIALI E COLORI

GRANITEK
NATURAL GRANITE EFFECT

Euro **378**

METAL

- M79 Aluminium LMF20079
- M73 Titanium LMF20073

GRANITEK
NATURAL GRANITE EFFECT

Euro **355**

MATT

- G68 Bianco LGF20068
- G40 Nero LGF20040

CLASSIC

- G62 Bianco Antico LGF20062
- G59 Antracite LGF20059
- G55 Grigio Pietra LGF20055
- G54 Nero Pietra LGF20054
- G52 Bianco Pietra LGF20052
- G51 Avena LGF20051

ACCESSORI CONSIGLIATI

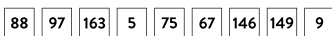

88 Element Tagliere Sliding 50cm



Solo Fox 200

ATH010QU
Euro **147**
Pag. 168

156 Element Drainer Flex 500

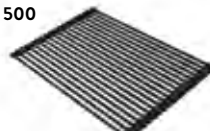

Esclusi Fox 200/Round

ARS023BK
Euro **88**
Pag. 173

146 Cover piletta



ACPM1000
Euro **21**
Pag. 179

FOX 180



Lavello 1 vasca

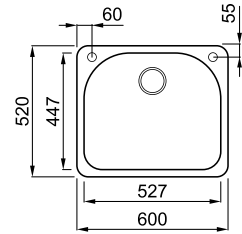

Disegno Tecnico approfondito: QR code a pag. 145



MATERIALI E COLORI

GRANITEK
NATURAL GRANITE EFFECT

Euro **391**

MATT

- G68 Bianco LGF18068BTP
- G40 Nero LGF18040BTP

CLASSIC

- G62 Bianco Antico LGF18062BTP
- G59 Antracite LGF18059BTP
- G51 Avena LGF18051BTP

CARATTERISTICHE

Dimensioni (mm)	600 x 520
Base (mm)	600
Foro da incasso (mm)	580 x 510 R32
Profondità Vasca (mm)	215
Orientamento	Non reversibile

ACCESSORI CONSIGLIATI

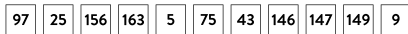

FOX ROUND



Lavello 1 vasca

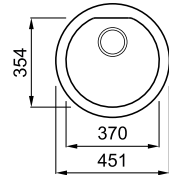

Disegno Tecnico approfondito: QR code a pag. 145



MATERIALI E COLORI

GRANITEK
NATURAL GRANITE EFFECT

Euro **288**

MATT

- G68 Bianco LGFROU68
- G40 Nero LGFROU40

CLASSIC

- G62 Bianco Antico LGFROU62
- G59 Antracite LGFROU59
- G51 Avena LGFROU51

ACCESSORIO CONSIGLIATO CESTELLO ROUND

ACI02301 Euro **71**



Installazione miscelatore sul top

CARATTERISTICHE

Dimensioni (mm)	ø 451
Base (mm)	450
Foro da incasso (mm)	ø 430
Profondità Vasca (mm)	200
Orientamento	Non reversibile

ACCESSORI CONSIGLIATI

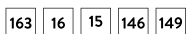

16 Tagliere in legno round

ATL02301
Euro **84**
Pag. 178



15 Cestello Round

ACI02301
Euro **71**
Pag. 178



Solo Fox Round

161 Kit 3 Spugne Fast Clean

DKP01000
Pag. 176







COLLEZIONE
MASTER

DAL DESIGN FORTEMENTE
CALDO

COLLEZIONE

MASTER

Una collezione di lavelli dal design country, perfetto per chi preferisce un ambiente caldo e classico ma con una forte personalità. Ogni modello è combinabile con numerosi accessori e molteplici colorazioni.



SOPRATOP



Lavello Master 550 G51 Avena con miscelatore Elba G51 Avena

1000

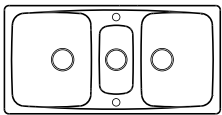

MASTER 550
PAG. 154

800

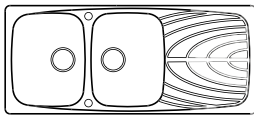

MASTER 500
PAG. 154

600

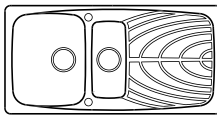

MASTER 475
PAG. 155

900

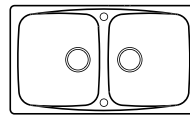

MASTER 450
PAG. 155

450

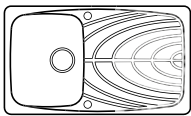

MASTER 400
PAG. 156

800

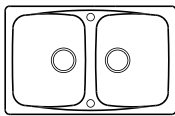

MASTER 350
PAG. 156

450

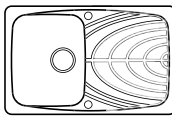

MASTER 300
PAG. 157



DISEGNI TECNICI
APPROFONDITI
LINEA MASTER

Corredo del lavello: Sifone salvaspazio, pilette e ganci.

GRANITEK
NATURAL GRANITE EFFECT

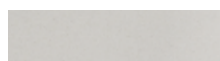

M79 Aluminium



M73 Titanium



G68 Bianco



G40 Nero



G62 Bianco Antico



G59 Antracite



G55 Grigio Pietra



G54 Nero Pietra



G52 Bianco Pietra



G51 Avena



**VASCA CON ANGOLI
ARROTONDATI**

I bordi interni arrotondati delle vasche conferiscono al lavello quel gusto vintage che è tornato prepotentemente di moda. Un classico che non tramonta mai.



ACCESSORI ELEMENT

Tagliere, drainer flex e pop up permettono di completare il lavello a proprio gusto e piacimento, rendendo le operazioni di preparazione del cibo più facili e pratiche.



**ACCESSORIO KIT
PILETTA OTTONATA**

L'accessorio piletta ottonata conferisce al lavello una sensazione di matericità tattile, nobilitando gli arredi e diventando protagonista di nuove sperimentazioni cromatiche.

MASTER 550



Lavello 2 vasche ½

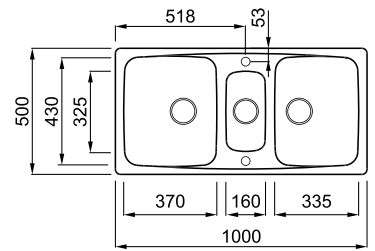

Disegno Tecnico approfondito: QR code a pag. 153

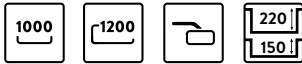

MATERIALI E COLORI

GRANITEK
NATURAL GRANITE EFFECT Euro **450**

CLASSIC

● G51 Avena LGM55051

CARATTERISTICHE

Dimensioni (mm) **1000 x 500**
 Base (mm) **1000**
 - se inizio composizione **1200**
 Foro da incasso (mm) **980 x 480**
 Profondità Vasca 1 (mm) **220**
 Profondità Vasca 2 (mm) **220**
 Profondità Vasca 3 (mm) **150**
 Orientamento **Reversibile**

ACCESSORI CONSIGLIATI



MASTER 500



Lavello 2 vasche con gocciolatoio

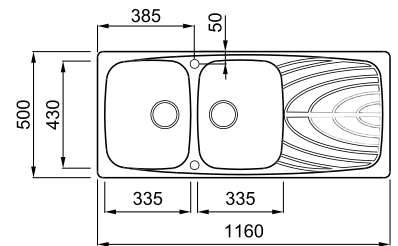

Disegno Tecnico approfondito: QR code a pag. 153



MATERIALI E COLORI

GRANITEK
NATURAL GRANITE EFFECT Euro **432**

METAL

● M79 Aluminium LMM50079

● M73 Titanium LMM50073

GRANITEK
NATURAL GRANITE EFFECT Euro **412**

MATT

○ G68 Bianco LGM50068

● G40 Nero LGM50040

CLASSIC

● G62 Bianco Antico LGM50062

● G59 Antracite LGM50059

● G55 Grigio Pietra LGM50055

● G54 Nero Pietra LGM50054

● G52 Bianco Pietra LGM50052

● G51 Avena LGM50051

CARATTERISTICHE

Dimensioni (mm) **1160 x 500**
 Base (mm) **800**
 Foro da incasso (mm) **1140 x 480**
 Profondità Vasca 1 (mm) **220**
 Profondità Vasca 2 (mm) **220**
 Orientamento **Reversibile**

ACCESSORI CONSIGLIATI

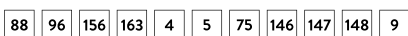

88 Element Tagliere
Sliding 50cm



ATH010OL

Euro **147**

Pag. 168

156 Element Drainer Flex 500

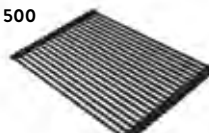

ARS023BK

Euro **88**

Pag. 173

148 Kit Piletta 2 vie e
troppopieno ottonati



APM2VSCTPGO

Euro **123**

Pag. 179

MASTER 475



CARATTERISTICHE

Dimensioni (mm)	1000 x 500
Base (mm)	600
Foro da incasso (mm)	980 x 480
Profondità Vasca 1 (mm)	220
Profondità Vasca 2 (mm)	140
Orientamento	Reversibile

ACCESSORI CONSIGLIATI

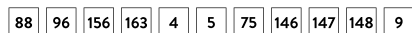

Lavello 1 vasca ½ con gocciolatoio

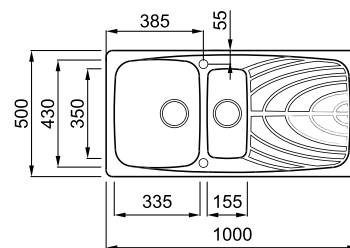

Disegno Tecnico approfondito: QR code a pag. 153

MATERIALI E COLORI

GRANITEK
NATURAL GRANITE EFFECT

Euro **427**

METAL

- M79 Aluminium LMM47579
- M73 Titanium LMM47573

GRANITEK
NATURAL GRANITE EFFECT

Euro **410**

MATT

- G68 Bianco LGM47568
- G40 Nero LGM47540

CLASSIC

- G62 Bianco Antico LGM47562
- G59 Antracite LGM47559
- G55 Grigio Pietra LGM47555
- G54 Nero Pietra LGM47554
- G52 Bianco Pietra LGM47552
- G51 Avena LGM47551

MASTER 450



CARATTERISTICHE

Dimensioni (mm)	860 x 500
Base (mm)	900
Foro da incasso (mm)	840 x 480
Profondità Vasca 1 (mm)	220
Profondità Vasca 2 (mm)	220
Orientamento	Reversibile

ACCESSORI CONSIGLIATI

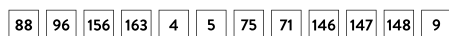

Lavello 2 vasche

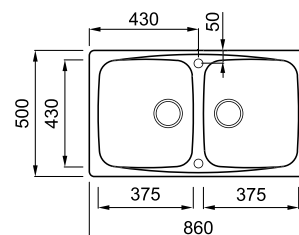

Disegno Tecnico approfondito: QR code a pag. 153

MATERIALI E COLORI

GRANITEK
NATURAL GRANITE EFFECT

Euro **395**

METAL

- M79 Aluminium LMM45079
- M73 Titanium LMM45073

GRANITEK
NATURAL GRANITE EFFECT

Euro **378**

MATT

- G68 Bianco LGM45068
- G40 Nero LGM45040

CLASSIC

- G62 Bianco Antico LGM45062
- G59 Antracite LGM45059
- G55 Grigio Pietra LGM45055
- G54 Nero Pietra LGM45054
- G52 Bianco Pietra LGM45052
- G51 Avena LGM45051

4 Tagliere scorrevole in legno



ATL01000
Euro **100**
Pag. 178

5 Colander



AVI03001
Euro **126**
Pag. 178

160 Spray Detergente Sgrassante Daily Clean



DLL01601
Pag. 175

MASTER 400



Lavello 1 vasca con gocciolatoio

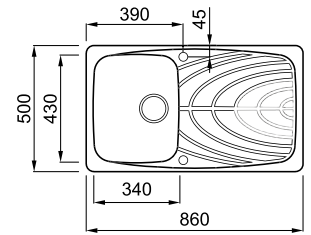

Disegno Tecnico approfondito: QR code a pag. 153



CARATTERISTICHE

Dimensioni (mm)	860 x 500
Base (mm)	450
Foro da incasso (mm)	840 x 480
Profondità Vasca (mm)	220
Orientamento	Reversibile

ACCESSORI CONSIGLIATI



MATERIALI E COLORI

GRANITEK NATURAL GRANITE EFFECT	Euro 374
METAL	
● M79 Aluminium	LMM40079
● M73 Titanium	LMM40073

GRANITEK NATURAL GRANITE EFFECT	Euro 355
MATT	
○ G68 Bianco	LGM40068
● G40 Nero	LGM40040
CLASSIC	
● G62 Bianco Antico	LGM40062
● G59 Antracite	LGM40059
● G55 Grigio Pietra	LGM40055
● G54 Nero Pietra	LGM40054
● G52 Bianco Pietra	LGM40052
● G51 Avena	LGM40051

MASTER 350



Lavello 2 vasche

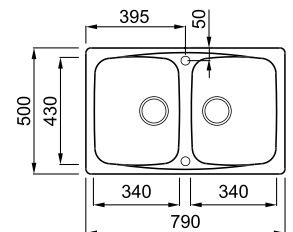

Disegno Tecnico approfondito: QR code a pag. 153



CARATTERISTICHE

Dimensioni (mm)	790 x 500
Base (mm)	800
- se inizio composizione	900
Foro da incasso (mm)	770 x 480
Profondità Vasca 1 (mm)	220
Profondità Vasca 2 (mm)	220
Orientamento	Reversibile

ACCESSORI CONSIGLIATI

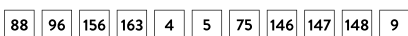

MATERIALI E COLORI

GRANITEK NATURAL GRANITE EFFECT	Euro 395
METAL	
● M79 Aluminium	LMM35079
● M73 Titanium	LMM35073

GRANITEK NATURAL GRANITE EFFECT	Euro 378
MATT	
○ G68 Bianco	LGM35068
● G40 Nero	LGM35040
CLASSIC	
● G62 Bianco Antico	LGM35062
● G59 Antracite	LGM35059
● G55 Grigio Pietra	LGM35055
● G54 Nero Pietra	LGM35054
● G52 Bianco Pietra	LGM35052
● G51 Avena	LGM35051

88 Element Tagliere Sliding 50cm



ATH010OL
Euro **147**
Pag. 168

156 Element Drainer Flex 500

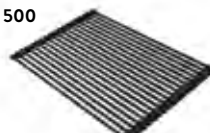

ARS023BK
Euro **88**
Pag. 173

149 Kit Piletta 1 via e troppopieno ottonato



APM1VCTPGO
Euro **70**
Pag. 179

MASTER 300



Lavello 1 vasca con gocciolatoio

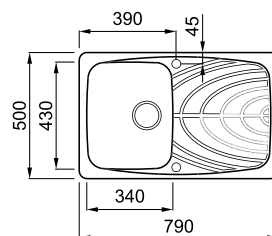

Disegno Tecnico approfondito: QR code a pag. 153



CARATTERISTICHE

Dimensioni (mm)	790 x 500
Base (mm)	450
Foro da incasso (mm)	770 x 480
Profondità Vasca (mm)	220
Orientamento	Reversibile

ACCESSORI CONSIGLIATI



MATERIALI E COLORI

GRANITEK
NATURAL GRANITE EFFECT

Euro **374**

METAL

- M79 Aluminium LMM30079
- M73 Titanium LMM30073

GRANITEK
NATURAL GRANITE EFFECT

Euro **355**

MATT

- G68 Bianco LGM30068
- G40 Nero LGM30040

CLASSIC

- G62 Bianco Antico LGM30062
- G59 Antracite LGM30059
- G55 Grigio Pietra LGM30055
- G54 Nero Pietra LGM30054
- G52 Bianco Pietra LGM30052
- G51 Avena LGM30051



97 Element Pop-Up
Push Control



ASP13002
Euro **37**
Pag. 171

75 Cestello



ACI01307
Euro **101**
Pag. 178

158 Spray Anticalcare
Disincrostante Daily Clean



DLA01601
Pag. 176



COLLEZIONE

LIVING

DAL DESIGN SEMPLICE
E FUNZIONALE



COLLEZIONE

LIVING

Una collezione di lavelli classica che con la loro semplicità e le molteplici dimensioni rendono l'ambiente perfettamente funzionale. È possibile associare ad ogni lavello una serie di accessori per aumentarne la funzionalità.



SOPRATOP



Lavello Living 300 G62 Bianco Antico con miscelatore Rio G62 Bianco Antico

800

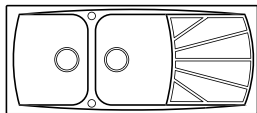

LIVING 500
PAG. 162

600

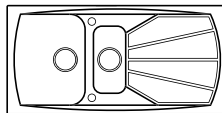

LIVING 475
PAG. 162

900

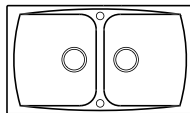

LIVING 450
PAG. 163

450

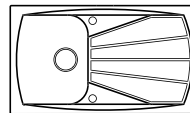

LIVING 400
PAG. 163

450

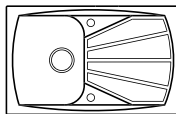

LIVING 300
PAG. 164

450

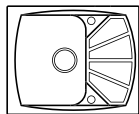

LIVING 125
PAG. 164



DISEGNI TECNICI
APPROFONDITI
LINEA LIVING

Corredo del lavello: Sifone salvaspazio, pilette e ganci.

GRANITEK
NATURAL GRANITE EFFECT



M79 Aluminium



M73 Titanium



G68 Bianco

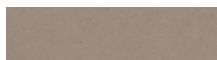

G43 Tortora



G40 Nero

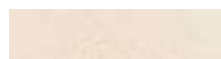

G62 Bianco Antico



G59 Antracite



G55 Grigio Pietra



G54 Nero Pietra



G52 Bianco Pietra



G51 Avena



**VASCA CON ANGOLI
ARROTONDATI**

I bordi interni arrotondati delle vasche conferiscono al lavello quel gusto vintage che è tornato prepotentemente di moda. Un classico che non tramonta mai.



ACCESSORI ELEMENT

Tagliere, drainer flex e pop up permettono di completare il lavello a proprio gusto e piacimento, rendendo le operazioni di preparazione del cibo più facili e pratiche.



**ACCESSORIO KIT
PILETTA OTTONATA**

L'accessorio piletta ottonata conferisce al lavello una sensazione di matericità tattile, nobilitando gli arredi e diventando protagonista di nuove sperimentazioni cromatiche.

LIVING 500



Lavello 2 vasche con gocciolatoio

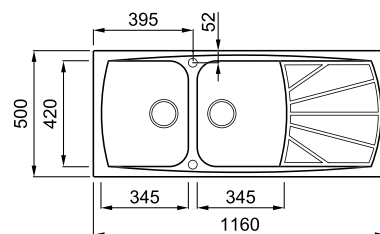

Disegno Tecnico approfondito: QR code a pag. 161



CARATTERISTICHE

Dimensioni (mm)	1160 x 500
Base (mm)	800
Foro da incasso (mm)	1140 x 480
Profondità Vasca 1 (mm)	210
Profondità Vasca 2 (mm)	210
Orientamento	Reversibile

MATERIALI E COLORI

GRANITEK NATURAL GRANITE EFFECT	Euro 387
METAL	
● M79 Aluminium	LML50079
● M73 Titanium	LML50073

GRANITEK NATURAL GRANITE EFFECT	Euro 372
MATT	
○ G68 Bianco	LGL50068
● G43 Tortora	LGL50043
● G40 Nero	LGL50040
CLASSIC	
● G62 Bianco Antico	LGL50062
● G59 Antracite	LGL50059
● G55 Grigio Pietra	LGL50055
● G54 Nero Pietra	LGL50054
● G52 Bianco Pietra	LGL50052
● G51 Avena	LGL50051

ACCESSORI CONSIGLIATI

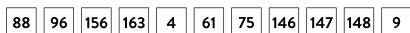

LIVING 475



Lavello 1 vasca 1/2 con gocciolatoio

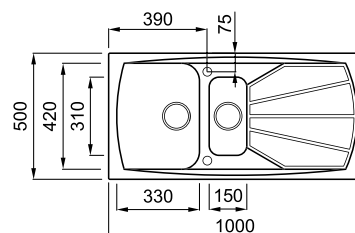

Disegno Tecnico approfondito: QR code a pag. 161



CARATTERISTICHE

Dimensioni (mm)	1000 x 500
Base (mm)	600
Foro da incasso (mm)	980 x 480
Profondità Vasca 1 (mm)	210
Profondità Vasca 2 (mm)	165
Orientamento	Reversibile

MATERIALI E COLORI

GRANITEK NATURAL GRANITE EFFECT	Euro 385
METAL	
● M79 Aluminium	LML47579
● M73 Titanium	LML47573

GRANITEK NATURAL GRANITE EFFECT	Euro 367
MATT	
○ G68 Bianco	LGL47568
● G43 Tortora	LGL47543
● G40 Nero	LGL47540
CLASSIC	
● G62 Bianco Antico	LGL47562
● G59 Antracite	LGL47559
● G55 Grigio Pietra	LGL47555
● G54 Nero Pietra	LGL47554
● G52 Bianco Pietra	LGL47552
● G51 Avena	LGL47551

ACCESSORI CONSIGLIATI

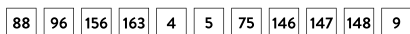

88 Element Tagliere Sliding 50cm



ATH010QU
Euro **147**
Pag. 168

156 Element Drainer Flex 500

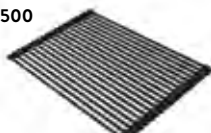

ARS023BK
Euro **88**
Pag. 173

75 Cestello



ACI01307
Euro **101**
Pag. 178

LIVING 450



Lavello 2 vasche

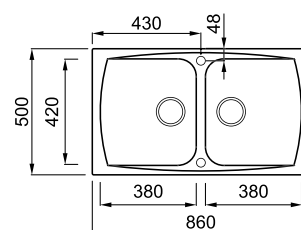

CARATTERISTICHE

Dimensioni (mm)	860 x 500
Base (mm)	900
Foro da incasso (mm)	840 x 480
Profondità Vasca 1 (mm)	210
Profondità Vasca 2 (mm)	210
Orientamento	Reversibile

ACCESSORI CONSIGLIATI

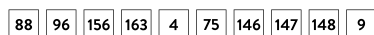

MATERIALI E COLORI

GRANITEK
NATURAL GRANITE EFFECT

Euro **355**

METAL

- M79 Aluminium LML45079
- M73 Titanium LML45073

GRANITEK
NATURAL GRANITE EFFECT

Euro **341**

MATT

- G68 Bianco LGL45068
- G43 Tortora LGL45043
- G40 Nero LGL45040

CLASSIC

- G62 Bianco Antico LGL45062
- G59 Antracite LGL45059
- G55 Grigio Pietra LGL45055
- G54 Nero Pietra LGL45054
- G52 Bianco Pietra LGL45052
- G51 Avena LGL45051

Disegno Tecnico approfondito: QR code a pag. 161

LIVING 400

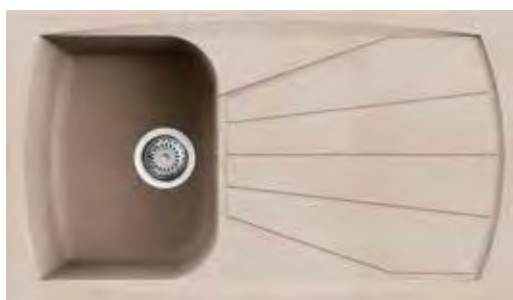

Lavello 1 vasca con gocciolatoio

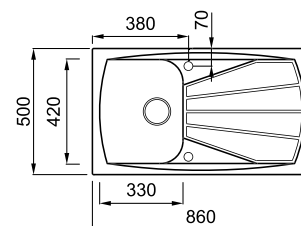

CARATTERISTICHE

Dimensioni (mm)	860 x 500
Base (mm)	450
Foro da incasso (mm)	840 x 480
Profondità Vasca (mm)	210
Orientamento	Reversibile

ACCESSORI CONSIGLIATI

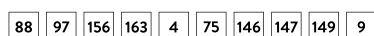

MATERIALI E COLORI

GRANITEK
NATURAL GRANITE EFFECT

Euro **334**

METAL

- M79 Aluminium LML40079
- M73 Titanium LML40073

GRANITEK
NATURAL GRANITE EFFECT

Euro **322**

MATT

- G68 Bianco LGL40068
- G43 Tortora LGL40043
- G40 Nero LGL40040

CLASSIC

- G62 Bianco Antico LGL40062
- G59 Antracite LGL40059
- G55 Grigio Pietra LGL40055
- G54 Nero Pietra LGL40054
- G52 Bianco Pietra LGL40052
- G51 Avena LGL40051

Disegno Tecnico approfondito: QR code a pag. 161

4 Tagliere scorrevole in legno



ATL01000
Euro **100**
Pag. 178

5 Colander



AVI03001
Euro **126**
Pag. 178

Solo Living 475

162 Panni in Microfibra Fast Clean



DKP01001
Pag. 177

LIVING 300



Lavello 1 vasca con gocciolatoio

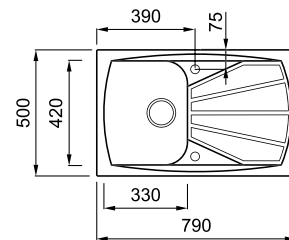

Disegno Tecnico approfondito: QR code a pag. 161



CARATTERISTICHE

Dimensioni (mm)	790 x 500
Base (mm)	450
Foro da incasso (mm)	770 x 480
Profondità Vasca (mm)	210
Orientamento	Reversibile

MATERIALI E COLORI

GRANITEK NATURAL GRANITE EFFECT	Euro 334
METAL	
● M79 Aluminium	LML30079
● M73 Titanium	LML30073

GRANITEK NATURAL GRANITE EFFECT	Euro 322
MATT	
○ G68 Bianco	LGL30068
● G43 Tortora	LGL30043
● G40 Nero	LGL30040
CLASSIC	
● G62 Bianco Antico	LGL30062
● G59 Antracite	LGL30059
● G55 Grigio Pietra	LGL30055
● G54 Nero Pietra	LGL30054
● G52 Bianco Pietra	LGL30052
● G51 Avena	LGL30051

ACCESSORI CONSIGLIATI

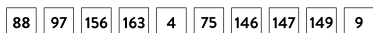

LIVING 125



Lavello 1 vasca con gocciolatoio

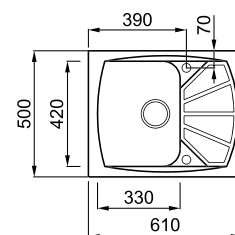

Disegno Tecnico approfondito: QR code a pag. 161



CARATTERISTICHE

Dimensioni (mm)	610 x 500
Base (mm)	450
Foro da incasso (mm)	600 x 495
Profondità Vasca (mm)	190
Orientamento	Reversibile

MATERIALI E COLORI

GRANITEK NATURAL GRANITE EFFECT	Euro 308
METAL	
● M79 Aluminium	LML12579
● M73 Titanium	LML12573

GRANITEK NATURAL GRANITE EFFECT	Euro 295
MATT	
○ G68 Bianco	LGL12568
● G43 Tortora	LGL12543
● G40 Nero	LGL12540
CLASSIC	
● G62 Bianco Antico	LGL12562
● G59 Antracite	LGL12559
● G55 Grigio Pietra	LGL12555
● G54 Nero Pietra	LGL12554
● G52 Bianco Pietra	LGL12552
● G51 Avena	LGL12551

ACCESSORI CONSIGLIATI

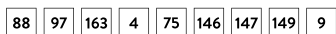

88 Element Tagliere Sliding 50cm



ATH0100L
Euro **147**
Pag. 168

156 Element Drainer Flex 500

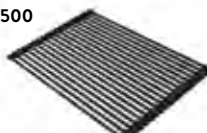

ARS023BK
Euro **88**
Pag. 173

Solo Living 300

146 Cover piletta



ACPM1000
Euro **21**
Pag. 179



149 Kit Piletta 1 via e troppopieno ottonato



APMIVCTPGO
Euro **70**
Pag. 179

97 Element Pop-Up Push Control



ASP13002
Euro **37**
Pag. 171

161 Kit 3 Spugne Fast Clean



DKP01000
Pag. 176

COLLEZIONE

ACCESSORI



ALLA SCOPERTA DI NUOVE SENSAZIONI

CON GLI ACCESSORI ELLECI SARÀ SEMPRE POSSIBILE CONFERIRE ALL'AMBIENTE CUCINA IL PROPRIO TOCCO PERSONALE, ESATTAMENTE COME TU DESIDERI.

Nuovi materiali, nuove finiture: sensazioni materiche e semplicità d'uso si fondono in un perfetto connubio di design e funzionalità.

ACCESSORI ELEMENT

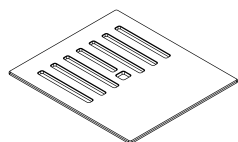

ELEMENT TAGLIERI
PAG. 168

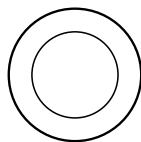

ELEMENT POP-UP
PAG. 171



ELEMENT DISPENSER
PAG. 172

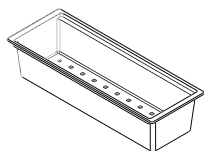

NEW

ELEMENT COLANDER
PAG. 173

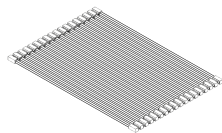

NEW

ELEMENT DRAINER FLEX
PAG. 173

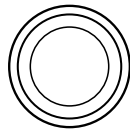

NEW

ELEMENT STYLE
PAG. 174



NEW

ELLECI BEAUTY
PAG. 175

ACCESSORI VARI

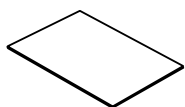

TAGLIERI
PAG. 178

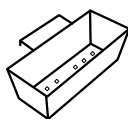

COLANDER
PAG. 178

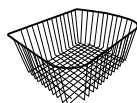

CESTELLI
PAG. 178

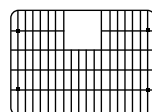

BOTTOM GRID
PAG. 179

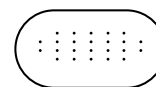

ALTRI ACCESSORI
PAG. 179

88 ELEMENT TAGLIERE SLIDING 50CM

TAGLIERE MULTIFUNZIONE IN HPL

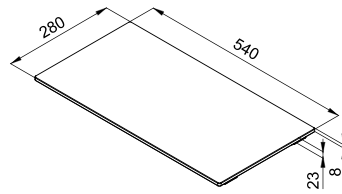

CARATTERISTICHE

Dimensione (mm) Euro
280 x 540 x 23 **147**

COLORI DISPONIBILI

 Nero
ATH010BK

 Grigio
ATH010GR

 Quercia
ATH010QU

 Olmo
ATH010OL

COMPATIBILITÀ COLLEZIONE

KARISMA

EGO

UNICO

EASY

TEKNO

FOX

MASTER

LIVING

SKY

Solo Sopratop

Escluso Round

Esclusi 425/290/Corner/Round 600

Esclusi Fox 360/340/330/180/Round

Escluso Round 435

89 ELEMENT TAGLIERE BEST LINE

TAGLIERE MULTIFUNZIONE IN HPL

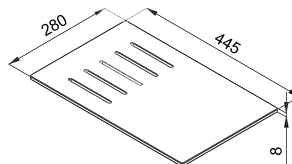

CARATTERISTICHE

Dimensione (mm) Euro
280 x 445 x 8 **123**

COLORI DISPONIBILI

 Nero
ATH020BK

 Grigio
ATH020GR

 Quercia
ATH020QU

 Olmo
ATH020OL

COMPATIBILITÀ COLLEZIONE

BEST

Esclusi Best 360 e Best 130

155 ELEMENT TAGLIERE FOX 360

NEW

TAGLIERE MULTIFUNZIONE IN HPL CON VASCHETTA

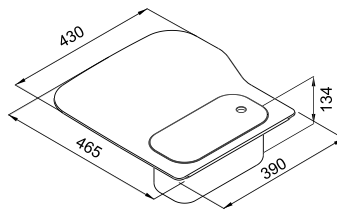

CARATTERISTICHE

Dimensione (mm) Euro
430 x 465 x 134 **180**

COLORI DISPONIBILI

 Quercia
ATH130QU

 Olmo
ATH130OL

COMPATIBILITÀ LAVELLO

FOX 360

91 ELEMENT TAGLIERE 420

TAGLIERE MULTIFUNZIONE IN HPL

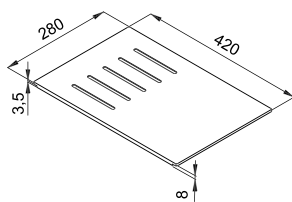

CARATTERISTICHE

Dimensione (mm) Euro
280 x 420 x 8 **123**

COLORI DISPONIBILI

● Nero ATH040BK ● Grigio ATH040GR ● Quercia ATH040QU ● Olmo ATH040OL

COMPATIBILITÀ COLLEZIONE

INTEGRA ZEN QUADRA SOPRATOP W-SQUARE YOGA CUBE

Escluso 50/340/440

93 ELEMENT TAGLIERE BEST WORKSTATION

TAGLIERE MULTIFUNZIONE IN HPL

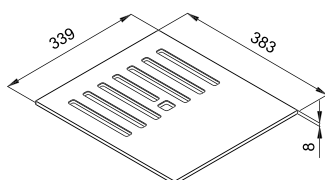

CARATTERISTICHE

Dimensione (mm) Euro
339 x 383 x 8 **127**

COLORI DISPONIBILI

● Nero ATH073BK ● Grigio ATH073GR ● Quercia ATH073QU ● Olmo ATH073OL

COMPATIBILITÀ LAVELLI

BEST 360 BEST 130



154

ELEMENT TAGLIERE GLOBE 910**NEW**

TAGLIERE MULTIFUNZIONE IN HPL

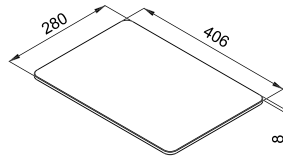
**CARATTERISTICHE**

Dimensione (mm) Euro
280 x 406 x 8 **123**

COLORI DISPONIBILI

Olmo
 ATHPL090OL

COMPATIBILITÀ LAVELLO

GLOBE 910

95

ELEMENT KIT DOGHE VALUE

DOGHE IN HPL

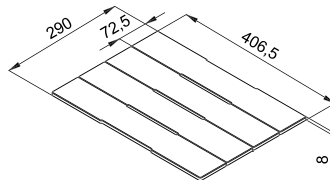
**CARATTERISTICHE**

Dimensione (mm) Euro
290 x 406 x 8 **102**

COLORI DISPONIBILI

Nero
 ATH083BK



White
 ATH083WH

COMPATIBILITÀ COLLEZIONE

VALUE



96 ELEMENT POP-UP PUSH CONTROL 2 VIE

KIT PILETTA AUTOMATICA A 2 VIE

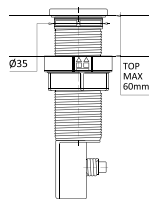
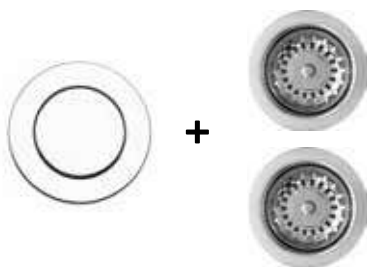

CARATTERISTICHE

Dimensione foro di incasso (mm)

Ø 35

COLORI DISPONIBILI



CR Cromato
ASP23002

Euro

71



Nero
ASP23002BK

Euro

130

COMPATIBILITÀ COLLEZIONE Solo lavelli a 2 vasche con installazione sopratop

BEST QUADRA UNICO EGO TEKNO EASY FOX MASTER LIVING

97 ELEMENT POP-UP PUSH CONTROL

KIT PILETTA AUTOMATICA A 1 VIA

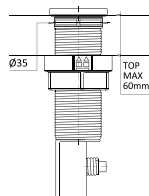
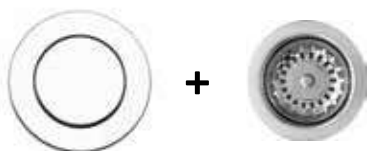

CARATTERISTICHE

Dimensione foro di incasso (mm)

Ø 35

COLORI DISPONIBILI



CR Cromato
ASP13002

Euro

37



Nero
ASP13002BK

Euro

96

COMPATIBILITÀ COLLEZIONE Solo lavelli a 1 vasca con installazione sopratop

BEST WORKSTATION BEST QUADRA UNICO EGO TEKNO EASY FOX MASTER LIVING

Escluso Round

98 ELEMENT POP-UP PUSH CONTROL KARISMA

KIT PILETTA QUADRATA AUTOMATICA A 1 VIA

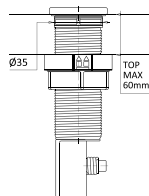

CARATTERISTICHE

Dimensione foro di incasso (mm) Euro

Ø 35

60

COLORI DISPONIBILI



CR Cromato
ASP16302

COMPATIBILITÀ COLLEZIONE

KARISMA

Solo Sopratop

99 ELEMENT POP-UP CUBE VALUE

KIT PILETTA AUTOMATICA ROTATIVA

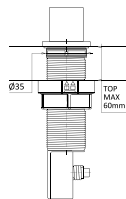

CARATTERISTICHE

Dimensione foro di incasso (mm) Euro
Ø 35 94

COLORI DISPONIBILI

●
 CR Cromato
 ASP17000

COMPATIBILITÀ COLLEZIONE

VALUE

25 ELEMENT DISPENSER SAPONE TONDO

DISPENSER SAPONE

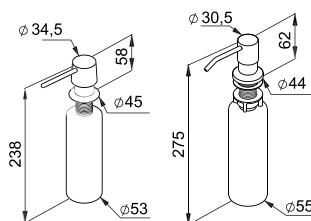

CARATTERISTICHE

Dimensione foro di incasso (mm)
Ø 35

COLORI DISPONIBILI

● Euro
 CR Cromato
 ADI02300 **42**

● Euro
 Nero
 ADI02300BK **64**

COMPATIBILITÀ COLLEZIONE

BEST WORKSTATION

QUADRA

Escluso 50

UNICO

Escluso 500

EASY

Esclusi 500/Round 600

FOX

Esclusi 450/200/Round

50 ELEMENT DISPENSER SAPONE QUADRATO

DISPENSER SAPONE

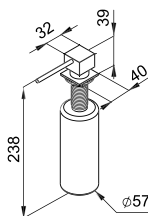

CARATTERISTICHE

Dimensione foro di incasso (mm) Euro
Ø 35 102

COLORI DISPONIBILI

●
 CR Cromato
 ADI02301

COMPATIBILITÀ COLLEZIONE

VALUE

KARISMA

Solo Sopratop

BEST WORKSTATION

QUADRA

Escluso 50

UNICO

Escluso 500

EASY

Esclusi 500/Round 600

152 ELEMENT COLANDER 418

NEW

COLANDER IN POLIPROPILENE

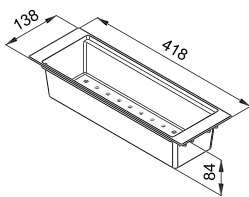

CARATTERISTICHE

Dimensione (mm) Euro
418 x 138 x 84 **64**

COLORI DISPONIBILI

●
Nero
AVP035BK

COMPATIBILITÀ COLLEZIONE

INTEGRA

ZEN

QUADRA

W-SQUARE

YOGA

CUBE

SKY

Esclusi 50/340/440

Solo 500/480/450/400

153 ELEMENT COLANDER BEST WORKSTATION

NEW

COLANDER IN POLIPROPILENE

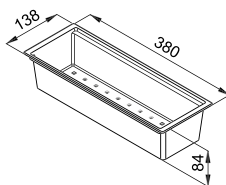

CARATTERISTICHE

Dimensione (mm) Euro
380 x 138 x 84 **64**

COLORI DISPONIBILI

●
Nero
AVP034BK

COMPATIBILITÀ COLLEZIONE

BEST WORKSTATION

156 ELEMENT DRAINER FLEX 500

NEW

DRAINER FLEX IN SILICONE CON BARRE IN ACCIAIO RIVESTITE

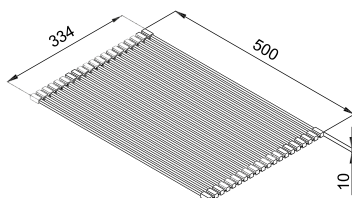

CARATTERISTICHE

Dimensione (mm) Euro
334 x 500 x 10 **88**

COLORI DISPONIBILI

●
Nero
ARS023BK

COMPATIBILITÀ COLLEZIONE

VALUE

QUADRA

DOGMA

UNICO

BEST WORKSTATION

EGO

EASY

BEST

FOX

MASTER

LIVING

SKY

Sottotop

Solo 440/340

Esclusi 425/290/135/Corner/Round 600

Esclusi 200/Round

Escluso 125

157 ELEMENT DRAINER FLEX 440 **NEW**

DRAINER FLEX IN SILICONE CON BARRE IN ACCIAIO RIVESTITE

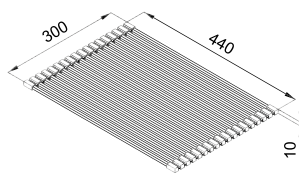

CARATTERISTICHE

Dimensione (mm) Euro
300 x 440 x 10 **80**

COLORI DISPONIBILI



Nero
ARS013BK

COMPATIBILITÀ COLLEZIONE

GLOBE

VALUE

Sopratop

KARISMA

INTEGRA

ZEN

QUADRA

Solo 350/200/150/130/110

EASY

Solo 425/290

W-SQUARE

YOGA

CUBE

163 ELEMENT COVER PILETTA MATERICA **NEW**

COVER PILETTA MATERICA

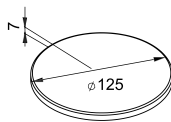

CARATTERISTICHE

Dimensione (mm) Euro
Ø 125 **42**

COLORI DISPONIBILI



K99 Dark Grey
AKCP1299



K97 Light Grey
AKCP1297



K96 White
AKCP1296



K95 Champagne
AKCP1295



K93 Dove Grey
AKCP1293



K86 Black
AKCP1286



G68 Bianco
AGCP1268



G48 Cemento
AGCP1248



G43 Tortora
AGCP1243



G40 Nero
AGCP1240

COMPATIBILITÀ COLLEZIONE

TUTTE LE COLLEZIONI

(Escluse Dogma, Value, Karisma, Integra, Best e Best Workstation)

164 ELEMENT KIT PILETTA E TROPPOPIENO BLACK **NEW**

KIT PILETTA E TROPPOPIENO



CARATTERISTICHE

Dimensione (mm) Euro
Ø 114 **74**

COLORI DISPONIBILI



Nero
COMPP90CTPLUXABK

COMPATIBILITÀ COLLEZIONE

INTEGRA

ZEN

BEST WORKSTATION

BEST

150 CREMA SMACCHIANTE DEEP CLEAN LAVELLI KERATEK

NEW



AZIONE

Questa crema smacchiante rimuove le macchie ostinate su tutti i lavelli Elleci in Keratek Plus. Il prodotto è indicato per la pulizia straordinaria dei lavelli Elleci.

MODO D'USO

- Applicare EXTRA ACTION sulla superficie asciutta.
- Lasciare agire per 5/10 minuti.
- Compiere dei piccoli movimenti rotatori con una spugna morbida.
- Risciacquare e asciugare accuratamente con un panno morbido o in microfibra antigraffio.



APPLICA



ATTENDI



PULISCI



RISCIACQUA E ASCIUGA

Codice

DLC01602

151 CREMA SMACCHIANTE DEEP CLEAN LAVELLI GRANITEK

NEW



AZIONE

Questa crema smacchiante rimuove le macchie ostinate su tutti i lavelli Elleci in Granitek. Il prodotto è indicato per la pulizia straordinaria dei lavelli Elleci.

MODO D'USO

- Applicare EXTRA ACTION sulla superficie asciutta.
- Lasciare agire per 5/10 minuti.
- Compiere dei piccoli movimenti rotatori con una spugna morbida.
- Risciacquare e asciugare accuratamente con un panno morbido o in microfibra antigraffio.



APPLICA



ATTENDI



PULISCI



RISCIACQUA E ASCIUGA

Codice

DLC01601

160 SPRAY DETERGENTE SGRASSANTE DAILY CLEAN

NEW



AZIONE

Questo spray sgrassante agisce rimuovendo le macchie più ostinate rispettando le superfici. Il prodotto è indicato per la pulizia periodica dei lavelli Elleci.

MODO D'USO

- Spruzzare ACTIVE SGRASSANTE sulla superficie da trattare.
- Lasciare agire qualche secondo.
- Pulire la superficie servendosi di una spugna morbida.
- Risciacquare e asciugare accuratamente la superficie con un panno morbido o in microfibra antigraffio.



SPRUZZA



ATTENDI



PULISCI



RISCIACQUA E ASCIUGA

Codice

DLL01601

158 SPRAY ANTICALCARE DISINCROSTANTE DAILY CLEAN

NEW



AZIONE

Questo spray anticalcare agisce sciogliendo le incrostazioni di calcare rispettando le superfici. Il prodotto è indicato per una pulizia periodica dei lavelli Elleci.

MODO D'USO

- Spruzzare ACTIVE ANTICALCARE sulla superficie da trattare.
- Lasciare agire qualche secondo.
- Pulire la superficie servendosi di una spugna morbida.
- Risciacquare e asciugare accuratamente la superficie con un panno morbido o in microfibra antigraffio.



SPRUZZA



ATTENDI



PULISCI



RISCIACQUA E ASCIUGA

Codice

DLA01601

159 SPRAY DETERGENTE PRODOTTI COLORATI DAILY CLEAN

NEW



AZIONE

Questo detergente pulisce a fondo e può essere usato su tutte le superfici colorate e smaltate. Il prodotto è adatto per una pulizia quotidiana dei miscelatori e degli elettrodomestici colorati Elleci.

MODO D'USO

- Spruzzare CLEAN POWER sulla superficie da trattare.
- Lasciare agire qualche secondo.
- Pulire la superficie servendosi di una spugna morbida.
- Risciacquare e asciugare accuratamente la superficie con un panno morbido o in microfibra antigraffio.



SPRUZZA



ATTENDI



PULISCI



RISCIACQUA E ASCIUGA

Codice

DLA01602

161 KIT 3 SPUGNE FAST CLEAN

NEW



FAST CLEAN

Questo kit composto da 3 spugne antigraffio è ideale per togliere i residui e mantenere l'estetica e la funzionalità del tuo prodotto Elleci, facilitano la rimozione delle macchie sulle superfici in composito e colorate dei prodotti Elleci.

Le spugne Fast Clean sono dotate di doppio strato utile a rimuovere lo sporco più intenso. La parte bianca agisce senza graffiare le superfici delicate mentre la parte blu più morbida, ha un potere assorbente.

Codice

DKP01000

162 PANNI IN MICROFIBRA FAST CLEAN

NEW

FAST CLEAN

Questo kit 2 panni in microfibra è perfetto per togliere i residui e mantenere l'estetica e la funzionalità del tuo prodotto Elleci agendo sulla superficie senza lasciare graffi e assorbendo ogni liquido lasciando asciutto il vostro prodotto rimuovendo polvere e sporco.

I panni in microfibra Fast Clean, estremamente assorbenti, sono ideali per asciugare accuratamente le superfici dei prodotti Elleci, grazie al motivo a scacchiera presente sul panno che rimuove ogni residuo.

Codice
DKP01001

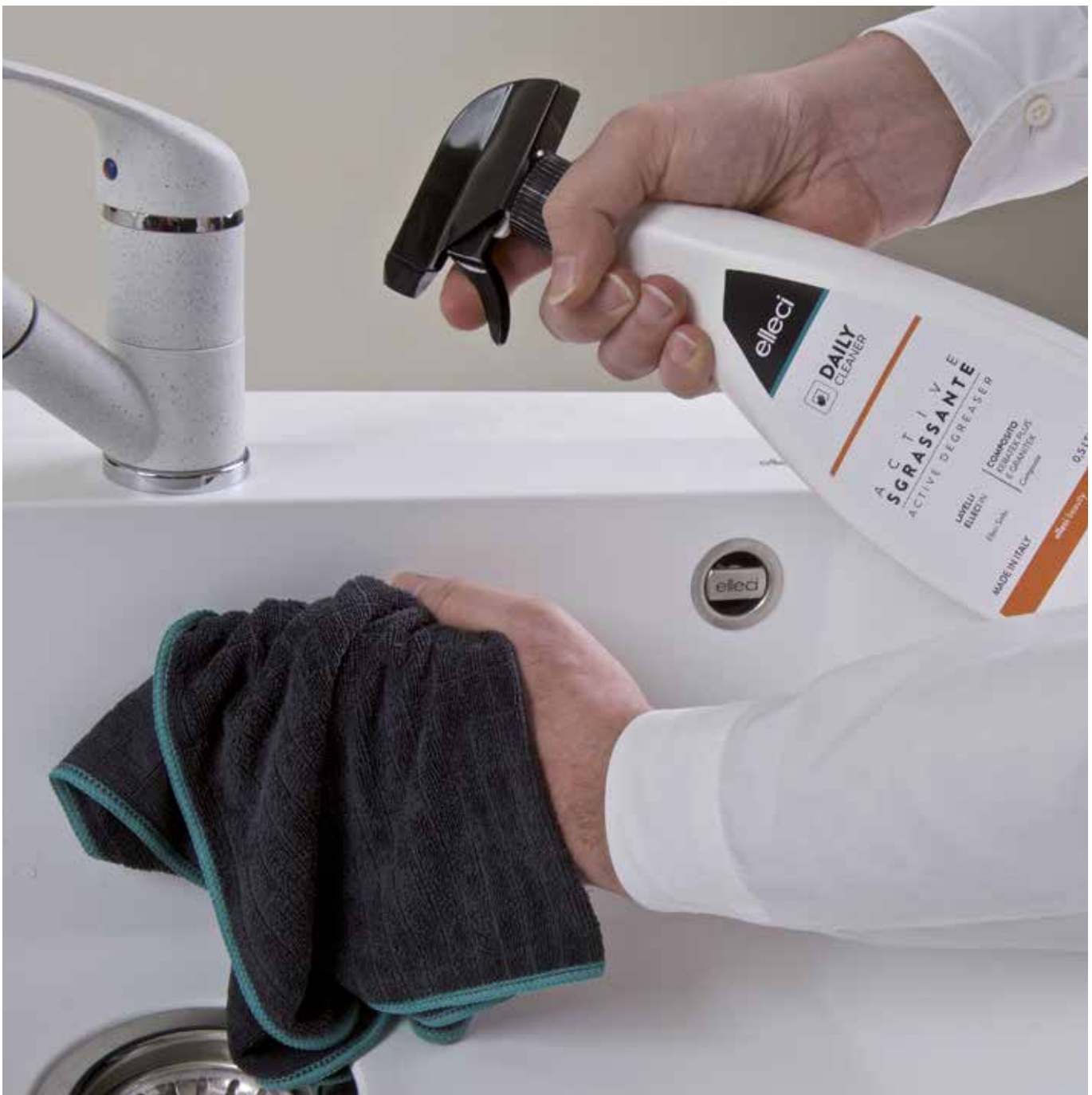

TAGLIERI

4 TAGLIERE SCORREVOLE IN LEGNO



CARATTERISTICHE

Dimensione (mm) 540 x 300
Codice ATL01000
Euro **100**

10 TAGLIERE IN LEGNO EGO ROUND



CARATTERISTICHE

Dimensione (mm) Ø435
Codice ATL02300
Euro **58**

16 TAGLIERE IN LEGNO FOX ROUND / SKY ROUND 435



CARATTERISTICHE

Dimensione (mm) Ø395
Codice ATL02301
Euro **84**

46 TAGLIERE SKY 360



CARATTERISTICHE

Dimensione (mm) 375 x 435
Codice ATL01303
Euro **86**

COLANDER

5 COLANDER



CARATTERISTICHE

Dimensione (mm) 322 x 195 x 95
Codice AVI03001
Euro **126**

51 COLANDER VALUE



CARATTERISTICHE

Dimensione (mm) 266 x 403 x 74
Codice AVI03303
Euro **144**

61 COLANDER STD L



CARATTERISTICHE

Dimensione (mm) 462 x 134 x 72
Codice AVI03305
Euro **126**

63 COLANDER EASY CORNER



CARATTERISTICHE

Dimensione (mm) 400 x 284 x 80
Codice AVI03307
Euro **116**

70 COLANDER BEST LINE



CARATTERISTICHE

Dimensione (mm) 444 x 142 x 103
Codice AVI03000
Euro **110**

CESTELLI

11 CESTELLO FOX 360



CARATTERISTICHE

Dimensione (mm) 405 x 312 x 195
Codice ACI03300
Euro **100**

8 CESTELLO EGO ROUND



CARATTERISTICHE

Dimensione (mm) Ø 345
Codice ACI02300
Euro **52**

30 CESTELLO SKY



CARATTERISTICHE

Dimensione (mm) 384 x 324 x 112
Codice ACI01304
Euro **92**

15 CESTELLO FOX ROUND / EASY ROUND / SKY ROUND 435



CARATTERISTICHE

Dimensione (mm) Ø 320
Codice ACI02301
Euro **71**

69 CESTELLO BEST LINE



CARATTERISTICHE

Dimensione (mm) 444 x 292 x 82
Codice ACI01306
Euro **89**

75 CESTELLO



CARATTERISTICHE

Dimensione (mm) 385 x 270 x 180
Codice ACI01307
Euro **101**

49 CESTELLO SKY 360



CARATTERISTICHE

Dimensione (mm) 375 x 250 x 190
Codice ACI01305
Euro **125**

BOTTOM GRID

43 BOTTOM GRID

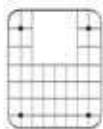

CARATTERISTICHE

Dimensione (mm) 277 x 348
Codice AGB01300
Euro **71**

67 BOTTOM GRID M

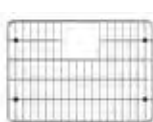

CARATTERISTICHE

Dimensione (mm) 445 x 310
Codice AGB01304
Euro **88**

68 BOTTOM GRID L

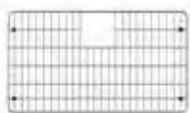

CARATTERISTICHE

Dimensione (mm) 590 x 334
Codice AGB01303
Euro **104**

71 BOTTOM GRID S



CARATTERISTICHE

Dimensione (mm) 285 x 300
Codice AGB01306
Euro **78**

ALTRI ACCESSORI

146 COVER PILETTA



Codice ACPM1000
Euro **21**

147 COVER PILETTA AUTOMATICA



Codice ACPA1000
Euro **21**

148 KIT PILETTA 2 VIE E TROPPOPIENO OTTONATI



Codice APM2VSCTPGO
Euro **123**

149 KIT PILETTA 1 VIA E TROPPOPIENO OTTONATO



Codice APM1VCTPGO
Euro **70**

42 DRAINER FLEX



CARATTERISTICHE

Dimensione (mm) 405 x 337
Codice ARI01300
Euro **120**

9 SCOLAPIATTI



CARATTERISTICHE

Dimensione (mm) 300 x 185 x 82
Codice ADI01300
Euro **48**

48 VASCHETTA IN POLICARBONATO SKY 360



CARATTERISTICHE

Dimensione (mm) 270 x 137 x 60
Codice AVP01302
Euro **22**

47 VASCHETTA SKY 360



CARATTERISTICHE

Dimensione (mm) 274 x 148 x 63
Codice AVI03002
Euro **60**

COLLEZIONE LAVELLI INOX

Configura il tuo lavello Inox.
Scegli tra collezione, tipologie e accessori
per configurare il tuo lavello da cucina ideale.

2 ANNI - YEARS
WARRANTY
GARANTITO



SATINATA



Opaco ma lucente, l'acciaio satinato conserva per anni, inalterati, i suoi valori di eleganza, igiene e resistenza all'usura dell'utilizzo quotidiano.



DISEGNI TECNICI
APPROFONDITI
GAMMA INOX

COLLEZIONE W-SQUARE

Vasche profonde ed alti spessori. Lavello dagli spigoli raggianti per rendere più semplice la pulizia.
Collezione a Raggio 25 con piletta quadrata dall'estetica ancora più accattivante.
Collezione W-Square con piletta quadrata, semifilo, filotop e sottotop in acciaio inox AISI 304 18/10.



SEMIFILO



FILOTOP



SOTTOTOP



PROFONDITÀ VASCA
200 mm



PILETTA
QUADRATA

COLLEZIONE YOGA NEW

Una serie di eleganti e funzionali vasche dagli spigoli interni raggianti, che è possibile installare in 3 modalità.
Semifilo: in appoggio sul piano di lavoro. Filotop: con inserimento in un alloggiamento profondo 1 mm ricavato sul top. Sottotop: sotto il piano di lavoro.
L'elegante disegno del fondo vasca a forma di diamante facilita il deflusso dell'acqua.
Collezione Yoga in acciaio inox AISI 304 18/10.



SEMIFILO



FILOTOP



SOTTOTOP



PROFONDITÀ VASCA
200 mm



FONDO
VASCA DIAMANTATO

COLLEZIONE CUBE NEW

La linea Cube si caratterizza per il Banco Rubinetteria integrato e per le sue linee rigorose e minimal.
L'elegante disegno del fondo vasca a forma di diamante facilita il deflusso dell'acqua.
Vasche singole e doppie rettangolari, versatili e pratiche che apportano funzionalità in cucina.
Collezione Cube in acciaio inox AISI 304 18/10.



SEMIFILO



FILOTOP



PROFONDITÀ VASCA
200 mm



MUNITO DI FORO
MISCELATORE



FONDO
VASCA DIAMANTATO

COLLEZIONE SKY

Per tutto il pianeta cucine. Design puro e semplice che trova posto in tutti i tipi di arredamento.
Collezione Sky da incasso in acciaio inox AISI 304 18/10.



SOPRATOP



PROFONDITÀ VASCA
205 - 160 mm



MUNITO DI FORO
MISCELATORE

W-SQUARE 700

Lavello 1 vasca

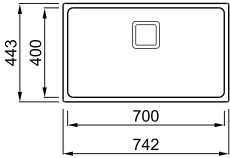

Disegno Tecnico approfondito:
QR code a pag. 180



CARATTERISTICHE

Dimensioni (mm)	742 x 443
Raggio Vasca (mm)	25
Base (mm)	800
Foro da incasso (mm)	Semifilo 730 x 430
Foro da incasso (mm)	Filotop 730 x 430
Foro da incasso (mm)	Sottotop 700 x 400 R25
Profondità Vasca (mm)	200
Orientamento	Non reversibile

Installazione miscelatore sul top

Satinata

Euro **486**

LIW700SACMU

ACCESSORI CONSIGLIATI

152 91 157 75

W-SQUARE 500

Lavello 1 vasca

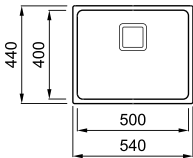

Disegno Tecnico approfondito:
QR code a pag. 180



CARATTERISTICHE

Dimensioni (mm)	540 x 440
Raggio Vasca (mm)	25
Base (mm)	600
Foro da incasso (mm)	Semifilo 530 x 430
Foro da incasso (mm)	Filotop 530 x 430
Foro da incasso (mm)	Sottotop 500 x 400 R25
Profondità Vasca (mm)	200
Orientamento	Non reversibile

Installazione miscelatore sul top

Satinata

Euro **401**

LIW500SACMU

ACCESSORI CONSIGLIATI

152 91 157 75

W-SQUARE 400

Lavello 1 vasca

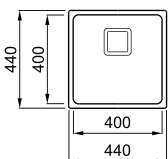

Disegno Tecnico approfondito:
QR code a pag. 180

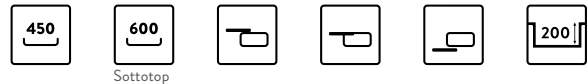

CARATTERISTICHE

Dimensioni (mm)	440 x 440
Raggio Vasca (mm)	25
Base (mm)	Semifilo/Filotop 450 - Sottotop 600
Foro da incasso (mm)	Semifilo 430 x 430
Foro da incasso (mm)	Filotop 430 x 430
Foro da incasso (mm)	Sottotop 400 x 400 R25
Profondità Vasca (mm)	200
Orientamento	Non reversibile

Installazione miscelatore sul top

Satinata

Euro **347**

LIW400SACMU

ACCESSORI CONSIGLIATI

152 91 157 75

YOGA 700

Lavello 1 vasca



NEW



CARATTERISTICHE

Dimensioni (mm)	740 x 440
Raggio Vasca (mm)	10
Base (mm)	800
Foro da incasso (mm)	Semifilo 730 x 430
Foro da incasso (mm)	Filotop 730 x 430
Foro da incasso (mm)	Sottotop 700 x 400 R10
Profondità Vasca (mm)	200
Orientamento	Non reversibile

Installazione miscelatore sul top

Satinata

Euro **549**

LIY700SAC

ACCESSORI CONSIGLIATI

152 91 157 75

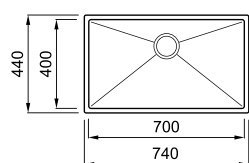

Disegno Tecnico approfondito:
QR code a pag. 180

YOGA 500

Lavello 1 vasca



NEW



CARATTERISTICHE

Dimensioni (mm)	540 x 440
Raggio Vasca (mm)	10
Base (mm)	600
Foro da incasso (mm)	Semifilo 530 x 430
Foro da incasso (mm)	Filotop 530 x 430
Foro da incasso (mm)	Sottotop 500 x 400 R10
Profondità Vasca (mm)	200
Orientamento	Non reversibile

Installazione miscelatore sul top

Satinata

Euro **446**

LIY500SAC

ACCESSORI CONSIGLIATI

152 91 157 75

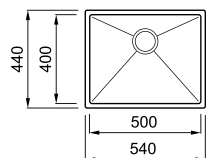

Disegno Tecnico approfondito:
QR code a pag. 180

ACCESSORI LAVELLI INOX

COLLEZIONI W-SQUARE / YOGA R10 / CUBE R10 / SKY

91 Element
Tagliere 420



ATH040OL

Euro **123**

Pag. 169

152 Element
Colander 418



AVP035BK

Euro **64**

Pag. 173

157 Element Drainer Flex 440

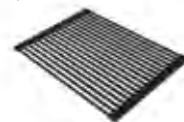

ARS013BK

Euro **77**

Pag. 174

COLLEZIONE SKY (Escluso Sky Round 435)

75 Cestello



ACI01307

Euro **97**

Pag. 178

88 Element Tagliere
Sliding 50cm



ATH010QU

Euro **147**

Pag. 168

156 Element Drainer Flex 500

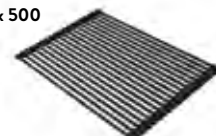

ARS023BK

Euro **85**

Pag. 173

CUBE 750 2V

Lavello 2 vasche



NEW



CARATTERISTICHE

Dimensioni (mm)	750 x 510
Raggio Vasca (mm)	10
Base (mm)	800
Foro da incasso (mm)	Semifilo 740 x 500
Foro da incasso (mm)	Filotop 740 x 500
Profondità Vasca (mm)	200
Orientamento	Non reversibile

Dotato di Banco Rubinetteria integrato

Satinata

Euro 644

LIU750SAC

ACCESSORI CONSIGLIATI

152 91 157 75

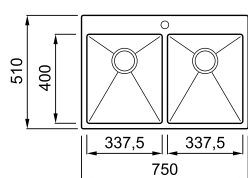

Disegno Tecnico approfondito:
QR code a pag. 180

CUBE 700

Lavello 1 vasca



NEW



CARATTERISTICHE

Dimensioni (mm)	750 x 510
Raggio Vasca (mm)	10
Base (mm)	800
Foro da incasso (mm)	Semifilo 740 x 500
Foro da incasso (mm)	Filotop 740 x 500
Profondità Vasca (mm)	200
Orientamento	Non reversibile

Dotato di Banco Rubinetteria integrato

Satinata

Euro 569

LIU700SAC

ACCESSORI CONSIGLIATI

152 91 157 75

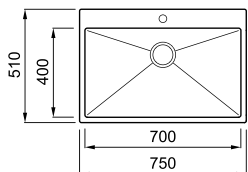

Disegno Tecnico approfondito:
QR code a pag. 180

CUBE 500

Lavello 1 vasca



NEW



CARATTERISTICHE

Dimensioni (mm)	550 x 510
Raggio Vasca (mm)	10
Base (mm)	600
Foro da incasso (mm)	Semifilo 540 x 500
Foro da incasso (mm)	Filotop 540 x 500
Profondità Vasca (mm)	200
Orientamento	Non reversibile

Dotato di Banco Rubinetteria integrato

Satinata

Euro 466

LIU500SAC

ACCESSORI CONSIGLIATI

152 91 157 75

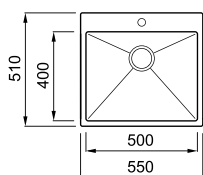

Disegno Tecnico approfondito:
QR code a pag. 180

SKY 500

Lavello 2 vasche con gocciolatoio

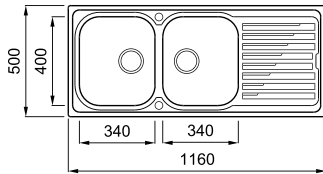

Disegno Tecnico approfondito: QR code a pag. 180



CARATTERISTICHE

Dimensioni (mm)	1160 x 500
Base (mm)	800
Foro da incasso (mm)	1140 x 480
Profondità Vasca 1 (mm)	180
Profondità Vasca 2 (mm)	180
Orientamento	Non reversibile

Satinata - Vasca a Destra

Satinata - Vasca a Sinistra

Euro 300

Euro 300

LIK500SACDX

LIK500SAC SX

ACCESSORI CONSIGLIATI

156 88 152 30

SKY 480

Lavello 1 vasca con gocciolatoio

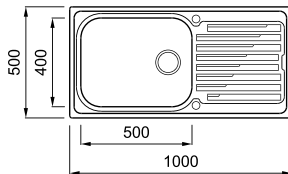

Disegno Tecnico approfondito: QR code a pag. 180



CARATTERISTICHE

Dimensioni (mm)	1000 x 500
Base (mm)	600
Foro da incasso (mm)	980 x 480
Profondità Vasca (mm)	205
Orientamento	Non reversibile

Satinata - Vasca a Destra

Satinata - Vasca a Sinistra

Euro 291

Euro 291

LIK480SACDX

LIK480SAC SX

ACCESSORI CONSIGLIATI

156 88 152 30

SKY 450

Lavello 2 vasche

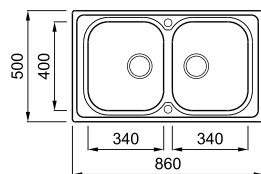

Disegno Tecnico approfondito: QR code a pag. 180



CARATTERISTICHE

Dimensioni (mm)	860 x 500
Base (mm)	800
- se inizio composizione	900
Foro da incasso (mm)	840 x 480
Profondità Vasca 1 (mm)	180
Profondità Vasca 2 (mm)	180
Orientamento	Reversibile

Satinata

Euro 271

LIK450SAC

ACCESSORI CONSIGLIATI

156 88 152 30

SKY 400

Lavello 1 vasca con gocciolatoio

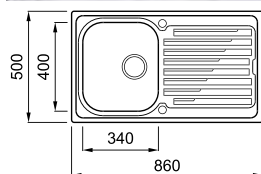

Disegno Tecnico approfondito: QR code a pag. 180



CARATTERISTICHE

Dimensioni (mm)	860 x 500
Base (mm)	450
Foro da incasso (mm)	840 x 480
Profondità Vasca (mm)	180
Orientamento	Non reversibile

Satinata - Vasca a Destra

Satinata - Vasca a Sinistra

Euro 223

Euro 223

LIK400SACDX

LIK400SAC SX

ACCESSORI CONSIGLIATI

156 88 152 30

SKY 360

Lavello 1 vasca

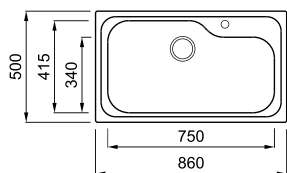

Disegno Tecnico approfondito: QR code a pag. 180



CARATTERISTICHE

Dimensioni (mm) **860 x 500**
 Base (mm) **900**
 Foro da incasso (mm) **840 x 480**
 Profondità Vasca (mm) **190**
 Orientamento **Non reversibile**

Satinata

Euro **362**

LIK360SAC

ACCESSORI CONSIGLIATI

156 88 46 47 48 49

SKY 125

Lavello 1 vasca con gocciolatoio

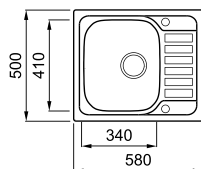

Disegno Tecnico approfondito: QR code a pag. 180



CARATTERISTICHE

Dimensioni (mm) **580 x 500**
 Base (mm) **450**
 Foro da incasso (mm) **560 x 480**
 Profondità Vasca (mm) **170**
 Orientamento **Non reversibile**

Satinata - Vasca a Destra

Satinata - Vasca a Sinistra

Euro **120**

Euro **120**

LIX125SACDX

LIX125SACSX

ACCESSORI CONSIGLIATI

156 88 30

SKY ROUND 435

Lavello 1 vasca

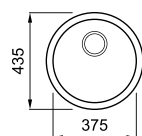

Disegno Tecnico approfondito: QR code a pag. 180



CARATTERISTICHE

Dimensioni (mm) **ø 435**
 Base (mm) **450**
 Foro da incasso (mm) **ø 415**
 Profondità Vasca (mm) **160**
 Orientamento **Non reversibile**

Satinata

Euro **112**

LIKROUSAC

ACCESSORI CONSIGLIATI

15

SKY CORNER

Lavello angolare 2 vasche con gocciolatoio

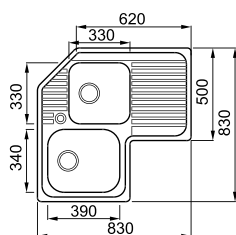

Disegno Tecnico approfondito: QR code a pag. 180



CARATTERISTICHE

Dimensioni (mm) **830 x 830**
 Base (mm) **Angolare da disegno**
 Foro da incasso (mm) **210**
 Profondità Vasca 1 (mm) **200**
 Profondità Vasca 2 (mm) **200**
 Orientamento **Non reversibile**

Satinata - Vasca a Destra

Satinata - Vasca a Sinistra

Euro **752**

Euro **752**

LIKORSACDX

LIKORSACSX

ACCESSORI CONSIGLIATI

156 88 30

COLLEZIONE

MISCELATORI

2 ANNI - YEARS
WARRANTY
GARANTITO

UNA SCELTA DI STILE

Essere se stessi in ogni ambiente e scegliere di esprimere la propria personalità: oggi è possibile grazie alla nuova collezione di miscelatori Elleci.

Nuove forme, tecnologie innovative, e colori sempre in armonia cromatica con i lavelli Elleci, per dar loro un tocco di personalità in più.

In gamma trovano spazio miscelatori capaci di soddisfare qualsiasi esigenza: miscelatori di design, miscelatori con doccette estraibili per raggiungere facilmente ogni angolo del lavello, miscelatori reclinabili adatti per le installazioni sottofinestra. C'è solo l'imbarazzo della scelta.

QUESTIONE DI FEELING

Un ambiente di qualità prevede la cura di ogni dettaglio. I nostri miscelatori si abbinano cromaticamente ai lavelli grazie al sapiente utilizzo del colore. Cromie uniche che rendono compatibili tra loro gli elementi della cucina, per una piacevole esperienza visiva.



DESIGN BLACK MATT

La nuova finitura Black Matt Elleci si caratterizza per la sua capacità di interpretare tendenze stilistiche, proponendo nuovi accostamenti cromatici e valorizzando l'ambiente circostante.



NUOVI MISCELATORI BIO

La nuova linea composta da quattro miscelatori certificati antibatterici grazie al trattamento specifico superficiale di verniciatura a ioni d'argento.



SISTEMA FILTRANTE



Il sistema filtrante Elleci trasforma il rubinetto della tua cucina in una sorgente d'acqua fresca e depurata. Un miscelatore con sistema filtrante fornisce acqua filtrata ogni volta che serve.

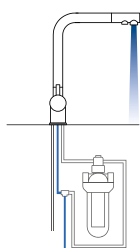

1. ACQUA FREDDA

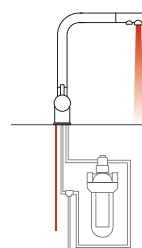

2. ACQUA CALDA

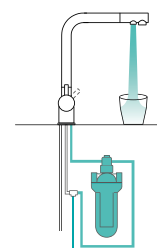

3. ACQUA DEPURATA

BIO **NEW**

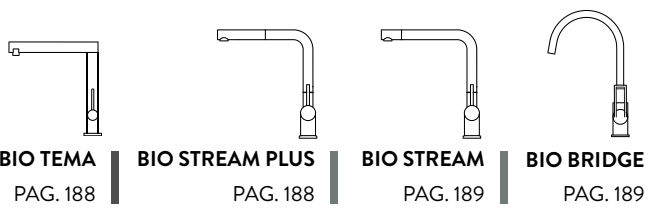

DESIGN BLACK MATT **NEW**

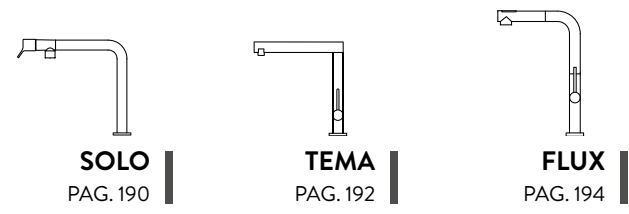

DESIGN

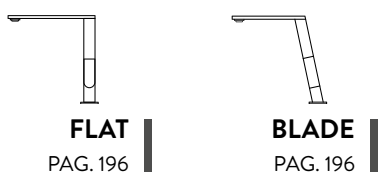

PROFESSIONAL



FILTRANTE



RECLINABILI

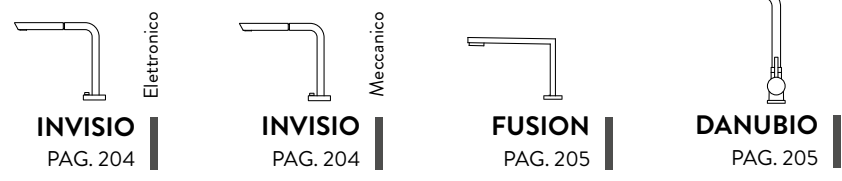

MODERN CANNA L



MODERN CANNA CURVA

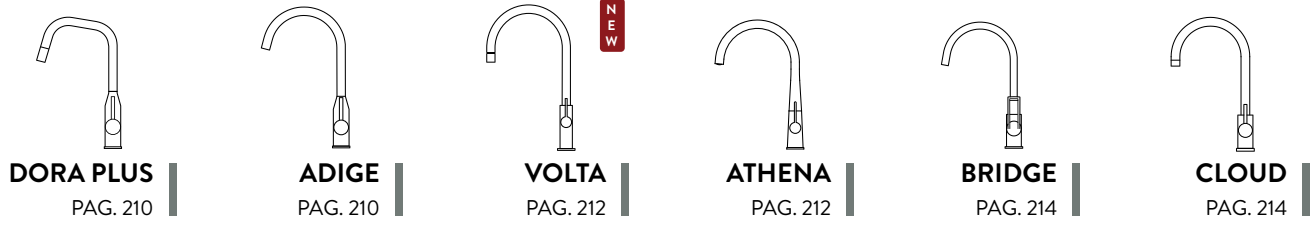

COUNTRY



BASIC



MISCELATORI

BIO TEMA

Miscelatore con trattamento antibatterico, monocomando con canna girevole

NEW

CARATTERISTICHE

Dimensioni Foro (ømm) 35
Base (mm) 50
Rotazione Canna 360°
Flessibile
Cartuccia (ømm) 25

COLORI ABBINABILI

KERATEK plus
CERAMIC NANOTECHNOLOGY CINE

Euro 578

● K86 Black

MKKTEM86AB

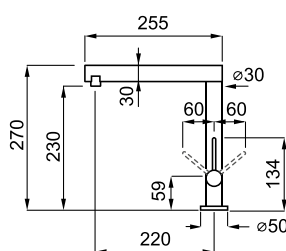

BIO STREAM PLUS

Miscelatore con trattamento antibatterico, monocomando con canna girevole e doccetta estraibile

NEW

CARATTERISTICHE

Dimensioni Foro (ømm) 35
Base (mm) 50
Rotazione Canna 360°
Flessibile
Cartuccia (ømm) 35

COLORI ABBINABILI

KERATEK plus
CERAMIC NANOTECHNOLOGY CINE

Euro 438

● K86 Black

MKKSTP86AB

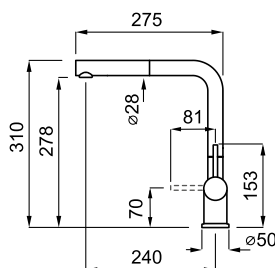

BIO STREAM

Miscelatore con trattamento antibatterico, monocomando con canna girevole

NEW

CARATTERISTICHE

Dimensioni Foro (ømm) 35
Base (mm) 50
Rotazione Canna 360°
Flessibile
Cartuccia (ømm) 35

COLORI ABBINABILI

KERATEK plus
CERAMIC NANOTECHNOLOGY CN6

Euro 386

● K86 Black

MKKSTR86AB

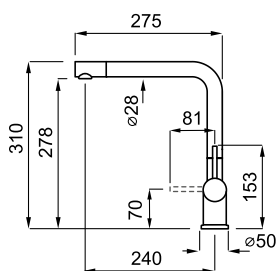

BIO BRIDGE

Miscelatore con trattamento antibatterico, monocomando con canna girevole

NEW

CARATTERISTICHE

Dimensioni Foro (ømm) 35
Base (mm) 50
Rotazione Canna 360°
Flessibile
Cartuccia (ømm) 35

COLORI ABBINABILI

KERATEK plus
CERAMIC NANOTECHNOLOGY CN6

Euro 307

● K86 Black

MKKBRI86AB

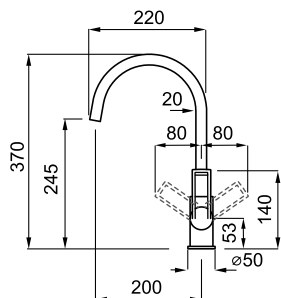

SOLO

Miscelatore monocomando con canna girevole

NEW

CARATTERISTICHE

Dimensioni Foro (ømm) 35
Base (mm) 50
Rotazione Canna 90°
Flessibile
Cartuccia (ømm) 25

35
50
90°
Inox 3/8"
25

COLORI ABBINABILI

BLACK MATT Euro 672
● BK Black Matt MOKSOLBK
CROMATO Euro 586
● CR Cromato MIKSOLCR

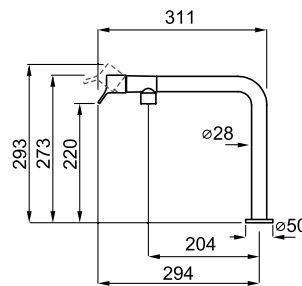

Miscelatore: Solo BK Black Matt
Lavello: Best 360 K86 Black



MISCELATORI

TEMA

Miscelatore monocomando con canna girevole

NEW

CARATTERISTICHE

Dimensioni Foro (ømm) 35

Base (mm) 50

Rotazione Canna 360°

Flessibile

Cartuccia (ømm) 25

Inox 3/8"
25

COLORI ABBINABILI

CROMATO

CR Cromato Euro 498

MIKTEMCR

KERATEK Plus
CERAMIC NANOTECHNOLOGY ONE

Euro 552

K99 Dark Grey MKKTEM99

K97 Light Grey MKKTEM97

K96 White MKKTEM96

K95 Champagne MKKTEM95

K93 Dove Grey MKKTEM93

K86 Black MKKTEM86

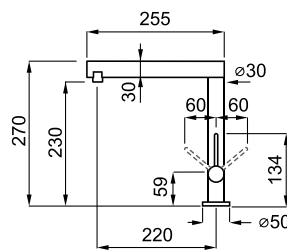

Miscelatore: Tema K86 Black
Lavello: Best 360 K86 Black



FLUX

Miscelatore monocomando con canna girevole e doccetta con cambio getto

NEW

CARATTERISTICHE

Dimensioni Foro (ømm) 35
Base (mm) 50
Rotazione Canna 360°
Flessibile
Cartuccia (ømm) 25



COLORI ABBINABILI

- | | |
|-------------------|----------|
| BLACK MATT | Euro 455 |
| ● BK Black Matt | MOKFLUBK |
| CROMATO | Euro 412 |
| ● CR Cromato | MIKFLUCR |

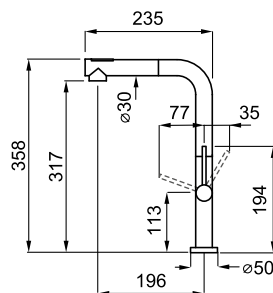

Miscelatore: Flux BK Black Matt
Lavello: Best 360 K86 Black



MISCELATORI



FLAT

Miscelatore monocomando con canna girevole

CARATTERISTICHE

Dimensioni Foro (ømm) 35
 Base (mm) 50 x 50
 Rotazione Canna 360°
 Flessibile
 Cartuccia (ømm) 25

35
 50 x 50
 360°
 Inox 3/8"
 25

COLORI ABBINABILI

CROMATO Euro 552
 ● CR Cromato MIKFLACR
KERATEK Plus Euro 661
CERAMIC NANOTECHNOLOGY ONE
 ○ K96 White MKKFLA96
 ● K86 Black MKKFLA86

GRANITEK Euro 661
NATURAL GRANITE EFFECT
MATT
 ○ G68 Bianco MGKFLA68
 ● G40 Nero MGKFLA40

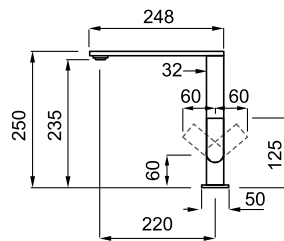

BLADE

Miscelatore monocomando con corpo inclinato e canna girevole

CARATTERISTICHE

Dimensioni Foro (ømm) 35
 Base (mm) 50 x 50
 Rotazione Canna 360°
 Flessibile
 Cartuccia (ømm) 25

35
 50 x 50
 360°
 Inox 3/8"
 25

COLORI ABBINABILI

CROMATO Euro 516
 ● CR Cromato MIKBLACR
KERATEK Plus Euro 612
CERAMIC NANOTECHNOLOGY ONE
 ○ K96 White MKKBLA96
 ● K86 Black MKKBLA86

GRANITEK Euro 612
NATURAL GRANITE EFFECT
MATT
 ○ G68 Bianco MGKBLA68
 ● G40 Nero MGKBLA40

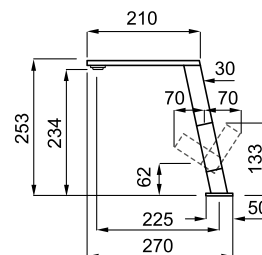

Miscelatore: **Blade K96 White**
Lavello: **Quadra 130 K96 White**



WAVE

Miscelatore monocomando con canna alta girevole in silicone e doccetta estraibile

NEW



CARATTERISTICHE

Dimensioni Foro (ømm) 35

Base (mm) 50

Rotazione Canna 360°

Flessibile

Cartuccia (ømm) 25



35
50
360°
Inox 3/8"
25

COLORI ABBINABILI

BLACK MATT

Euro 357

● BK Black Matt

MOKWAVBK

CROMATO

Euro 315

● CR Cromato

MIKWAVCR

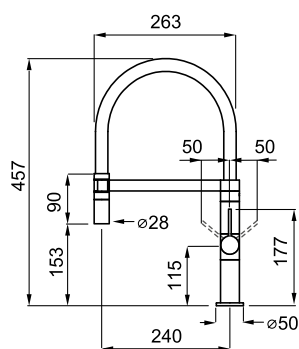

Miscelatore: Wave BK Black Matt
Lavello: Best 360 K86 Black



LENA

Miscelatore monocomando con canna alta girevole e doccetta con cambio getto



CARATTERISTICHE

Dimensioni Foro (ømm) 35
 Base (mm) 48
 Rotazione Canna 360°
 Flessibile
 Cartuccia (ømm) 25



COLORI ABBINABILI

CROMATO

Euro 436

● CR Cromato

MIKLENCR

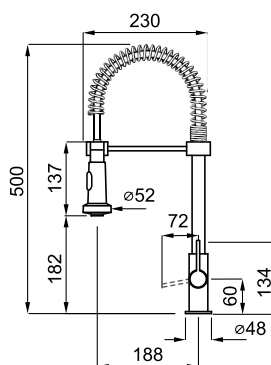

CHEF

Miscelatore monocomando con canna alta girevole e doccetta con cambio getto



CARATTERISTICHE

Dimensioni Foro (ømm) 35
 Base (mm) 50
 Rotazione Canna 360°
 Flessibile
 Cartuccia (ømm) 35



COLORI ABBINABILI

CROMATO

Euro 352

● CR Cromato

MIKCHECR

KERATEK plus
CERAMIC NANOTECHNOLOGY CMB

Euro 390

● K86 Black

MKKCHE86

GRANITEK
NATURAL GRANITE EFFECT

Euro 390

MATT

● G40 Nero

MGKCHE40

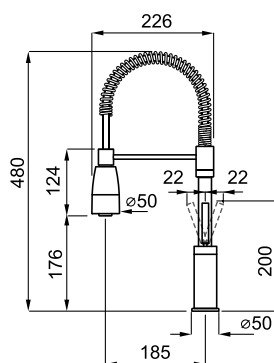

Miscelatore: **Chef K86 Black**
Lavello: **Best 360 K86 Black**



TOURMALINE

Miscelatore filtrante monocomando con canna girevole

CARATTERISTICHE

Dimensioni Foro (ømm)	35
Base (mm)	50
Rotazione Canna	360°
Flessibile	Inox 3/8"
Cartuccia (ømm)	35



COLORI ABBINABILI

KERATEK plus
CERAMIC NANOTECHNOLOGY CMB

○ K96 White	Euro 311
● K86 Black	MKKTU96
	MKKTU86

GRANITEK
NATURAL GRANITE EFFECT

MATT	Euro 311
○ G68 Bianco	MGKTU68
● G40 Nero	MGKTU40
CLASSIC	
● G51 Avena	MGKTU51

ACCESSORIO

Kit Filtraggio

AFI01300
Euro **154**

Ricambio Filtro

RFP01300
Euro **80**

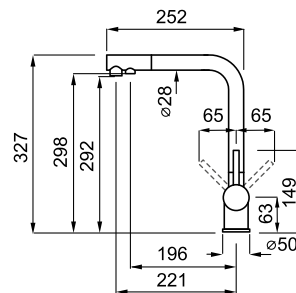

Miscelatore: **Tourmaline IN Inox**
Lavello: **Zen 105 K93 Dove Grey**



MISCELATORI

SISTEMA DI FILTRAGGIO

Il sistema filtrante Elleci trasforma il rubinetto della tua cucina in una sorgente d'acqua fresca e depurata. Un miscelatore con sistema filtrante riduce il contenuto di metalli pesanti, cloro e calcare presenti nell'acqua del rubinetto ed è pratico da utilizzare poiché il filtro è collegato direttamente al rubinetto dell'impianto idrico di casa e fornisce in tal modo acqua filtrata ogni volta che serve.

La cartuccia di ricambio del filtro assicura una capacità filtrante di 4.000 litri, alla portata di 2 litri al minuto e rimuoverla e sostituirla è davvero semplice.

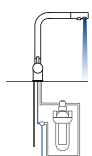

1. ACQUA FREDDA

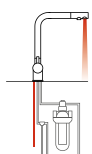

2. ACQUA CALDA

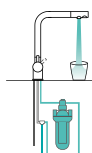

3. ACQUA DEPURATA



INOX

● IN Inox

Euro **311**

MIKTOUIN

ACCESSORIO

Kit Filtraggio

AFI01300

Euro **154**



Ricambio Filtro

RFP01300

Euro **80**





Il miscelatore Invisio Elettronico è dotato di un sofisticato ed intuitivo joystick elettronico a LED multicolor con indicazione cromatica della temperatura dell'acqua.

INVISIO ELETTRONICO

Elettromiscelatore a scomparsa con doccetta estraibile



CARATTERISTICHE

Dimensioni Foro (ømm)	48
Dimensioni Joystick (mm)	45
Dimensioni Foro Joystick (mm)	13
Base (mm)	63 x 56
Rotazione Canna	360°
Flessibile	Inox 3/8"
Cartuccia (ømm)	35



COLORI ABBINABILI

CROMATO	Euro 1795
● CR Cromato	EIKINVCR

INVISIO MECCANICO

Miscelatore a scomparsa con doccetta estraibile e comando remoto

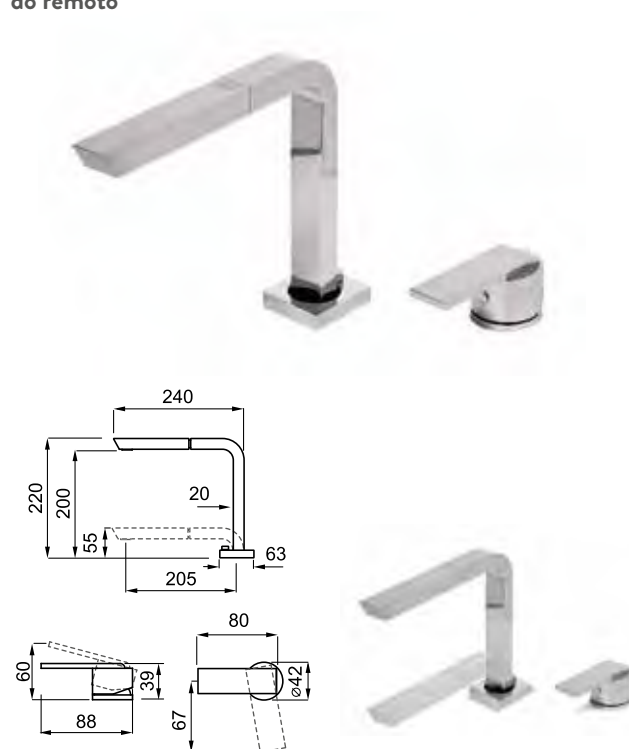

CARATTERISTICHE

Dimensioni Foro (ømm)	48
Dimensioni Foro Leva (mm)	35
Base (mm)	63 x 56
Rotazione Canna	360°
Flessibile	Inox 3/8"
Cartuccia (ømm)	35

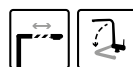

COLORI ABBINABILI

CROMATO	Euro 1056
● CR Cromato	MIKINVCR

FUSION

Miscelatore a scomparsa con comando remoto

CARATTERISTICHE

Dimensioni Foro (ømm)	38
Dimensioni Leva (mm)	52
Dimensioni Foro Leva (mm)	35
Base (mm)	52 x 52
Rotazione Canna	360°
Flessibile	Inox 3/8"
Cartuccia (ømm)	25



COLORI ABBINABILI

CROMATO

● CR Cromato

Euro **719**

MIKFUSCR

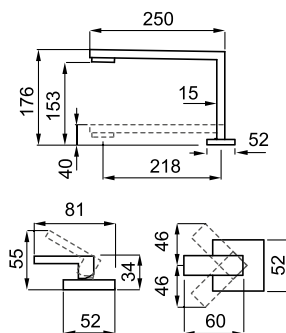

DANUBIO

Miscelatore monocomando reclinabile con canna girevole

CARATTERISTICHE

Dimensioni Foro (ømm)	35
Base (mm)	50
Rotazione Canna	360°
Flessibile	Inox 3/8"
Cartuccia (ømm)	40



COLORI ABBINABILI

CROMATO

● CR Cromato

Euro **369**

MIKDANCR

GRANITEK
NATURAL GRANITE EFFECT

Euro **412**

MATT

○ G68 Bianco

MGKDAN68

● G40 Nero

MGKDAN40

CLASSIC

● G51 Avena

MGKDAN51

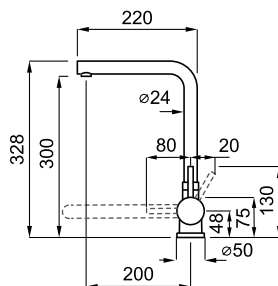

ARES

Miscelatore monocomando con canna girevole

NEW



CARATTERISTICHE

Dimensioni Foro (ømm) **35**
 Base (mm) **45**
 Rotazione Canna **360°**
 Flessibile **Inox 3/8"**
 Cartuccia (ømm) **25**

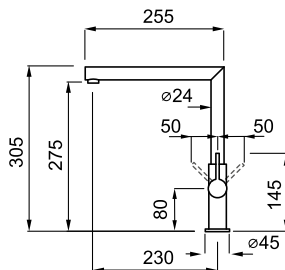

COLORI ABBINABILI

- CROMATO** Euro **345**
 ● CR Cromato MIKARECR
- KERATEK** Plus CERAMIC NANOTECHNOLOGY ONE Euro **429**
 ○ K96 White MKKARE96
 ● K86 Black MKKARE86

- GRANITEK** NATURAL GRANITE EFFECT Euro **429**
METAL
 ● M79 Aluminium MMKARE79
 ● M73 Titanium MMKARE73

- GRANITEK** NATURAL GRANITE EFFECT Euro **429**
MATT
 ○ G68 Bianco MGKARE68
 ● G48 Cemento MGKARE48
 ● G43 Tortora MGKARE43
 ● G40 Nero MGKARE40

STREAM

Miscelatore monocomando con canna girevole



CARATTERISTICHE

Dimensioni Foro (ømm) **35**
 Base (mm) **50**
 Rotazione Canna **360°**
 Flessibile **Inox 3/8"**
 Cartuccia (ømm) **35**

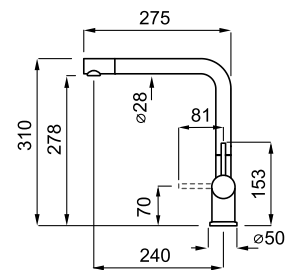

COLORI ABBINABILI

- CROMATO** Euro **315**
 ● CR Cromato MIKSTRCR
- KERATEK** Plus CERAMIC NANOTECHNOLOGY ONE Euro **359**
 ● K99 Dark Grey MKKSTR99
 ○ K96 White MKKSTR96
 ● K86 Black MKKSTR86

- GRANITEK** NATURAL GRANITE EFFECT Euro **359**
METAL
 ● M79 Aluminium MMKSTR79
 ● M73 Titanium MMKSTR73

- GRANITEK** NATURAL GRANITE EFFECT Euro **359**
MATT
 ○ G68 Bianco MGKSTR68
 ● G48 Cemento MGKSTR48
 ● G43 Tortora MGKSTR43
 ● G40 Nero MGKSTR40
CLASSIC
 ● G51 Avena MGKSTR51

STREAM PLUS

Miscelatore monocomando con canna girevole e doccetta estraibile

CARATTERISTICHE

Dimensioni Foro (ømm) 35
 Base (mm) 50
 Rotazione Canna 360°
 Flessibile
 Cartuccia (ømm) 35

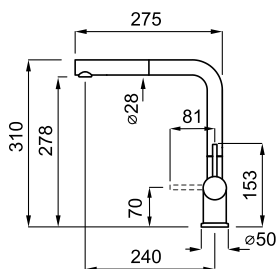

COLORI ABBINABILI

CROMATO

Euro 363

MIKSTPCR

● CR Cromato

KERATEK^{plus}

CERAMIC NANOTECHNOLOGY ONE

Euro 412

● K99 Dark Grey

MKKSTP99

● K97 Light Grey

MKKSTP97

○ K96 White

MKKSTP96

● K95 Champagne

MKKSTP95

● K93 Dove Grey

MKKSTP93

● K86 Black

MKKSTP86

GRANITEK

NATURAL GRANITE EFFECT

Euro 412

METAL

● M79 Aluminium

MMKSTP79

● M73 Titanium

MMKSTP73

GRANITEK

NATURAL GRANITE EFFECT

Euro 412

MATT

○ G68 Bianco

MGKSTP68

● G48 Cemento

MGKSTP48

● G43 Tortora

MGKSTP43

● G40 Nero

MGKSTP40

CLASSIC

● G51 Avena

MGKSTP51

Miscelatore: Stream Plus M79 Aluminium
 Lavello: Unico 410 M79 Aluminium



TRAIL PLUS

Miscelatore monocomando con canna girevole e doccetta estraibile

NEW



CARATTERISTICHE

Dimensioni Foro (ømm) 35
 Base (mm) 50
 Rotazione Canna 360°
 Flessibile
 Cartuccia (ømm) 35

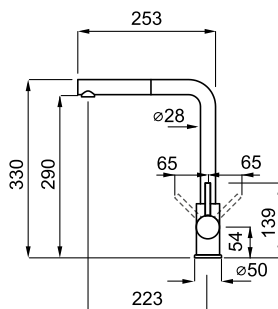

COLORI ABBINABILI

- CROMATO** Euro 292
- CR Cromato MIKTRPCR
- KERATEK^{Plus}** Euro 318
CERAMIC NANOTECHNOLOGY ONE
- K96 White MKKTRP96
 - K86 Black MKKTRP86

GRANITEK Euro 318
NATURAL GRANITE EFFECT

- METAL**
- M79 Aluminium MMKTRP79
 - M78 Espresso MMKTRP78
 - M73 Titanium MMKTRP73
 - M70 Ghisa MMKTRP70

GRANITEK Euro 318
NATURAL GRANITE EFFECT

- MATT**
- G68 Bianco MGKTRP68
 - G48 Cemento MGKTRP48
 - G43 Tortora MGKTRP43
 - G40 Nero MGKTRP40
- CLASSIC**
- G62 Bianco Antico MGKTRP62
 - G59 Antracite MGKTRP59
 - G51 Avena MGKTRP51

TRAIL

Miscelatore monocomando con canna girevole



CARATTERISTICHE

Dimensioni Foro (ømm) 35
 Base (mm) 50
 Rotazione Canna 360°
 Flessibile
 Cartuccia (ømm) 35

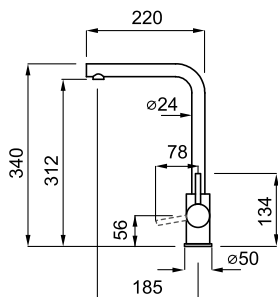

COLORI ABBINABILI

- CROMATO** Euro 208
- CR Cromato MIKTRACR
- KERATEK^{Plus}** Euro 240
CERAMIC NANOTECHNOLOGY ONE
- K99 Dark Grey MKKTRA99
 - K97 Light Grey MKKTRA97
 - K96 White MKKTRA96
 - K95 Champagne MKKTRA95
 - K93 Dove Grey MKKTRA93
 - K86 Black MKKTRA86

GRANITEK Euro 240
NATURAL GRANITE EFFECT

- METAL**
- M79 Aluminium MMKTRA79
 - M78 Espresso MMKTRA78
 - M73 Titanium MMKTRA73
 - M70 Ghisa MMKTRA70

GRANITEK Euro 240
NATURAL GRANITE EFFECT

- MATT**
- G68 Bianco MGKTRA68
 - G48 Cemento MGKTRA48
 - G43 Tortora MGKTRA43
 - G40 Nero MGKTRA40
- CLASSIC**
- G62 Bianco Antico MGKTRA62
 - G59 Antracite MGKTRA59
 - G51 Avena MGKTRA51

Miscelatore: Trail Plus M73 Titanium
Lavello: Quadra 105 Sottotop M73 Titanium



MISCELATORI

DORA PLUS

Miscelatore monocomando con canna girevole e doccetta estraibile



CARATTERISTICHE

Dimensioni Foro (ømm) 35
 Base (mm) 50
 Rotazione Canna 360°
 Flessibile
 Cartuccia (ømm) 35



35
 50
 360°
 Inox 3/8"
 35

COLORI ABBINABILI

INOX Euro **386**
 IN Inox MIKDRPIN
KERATEK Plus CERAMIC NANOTECHNOLOGY CNB Euro **386**
 K96 White MKKDRP96
 K86 Black MKKDRP86

GRANITEK

NATURAL GRANITE EFFECT

MATT Euro **386**
 G68 Bianco MGKDRP68
 G40 Nero MGKDRP40

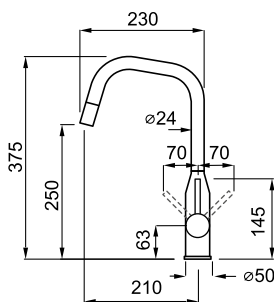

ADIGE

Miscelatore monocomando con canna girevole



CARATTERISTICHE

Dimensioni Foro (ømm) 35
 Base (mm) 50
 Rotazione Canna 360°
 Flessibile
 Cartuccia (ømm) 35



35
 50
 360°
 Inox 3/8"
 35

COLORI ABBINABILI

INOX Euro **317**
 IN Inox MIKADIIN
KERATEK Plus CERAMIC NANOTECHNOLOGY CNB Euro **317**
 K96 White MKKADI96
 K86 Black MKKADI86

GRANITEK

NATURAL GRANITE EFFECT

MATT Euro **317**
 G68 Bianco MGKADI68
 G40 Nero MGKADI40

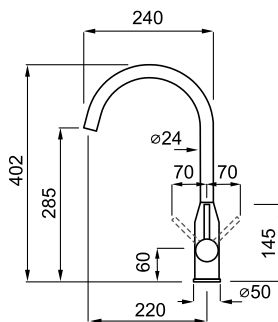

Miscelatore: Dora Plus IN Inox
Lavello: Zen 105 K93 Dove Grey



VOLTA

Miscelatore monocomando con canna girevole

NEW



CARATTERISTICHE

Dimensioni Foro (ømm) **35**
 Base (mm) **45**
 Rotazione Canna **360°**
 Flessibile **Inox 3/8"**
 Cartuccia (ømm) **25**

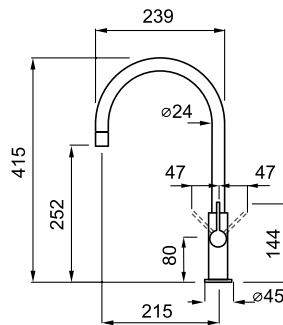

COLORI ABBINABILI

CROMATO Euro **287**
 CR Cromato MIKVTA96
KERATEK CERAMIC NANOTECHNOLOGY GNS Euro **356**
 K96 White MKKVTA96
 K86 Black MKKVTA86

GRANITEK NATURAL GRANITE EFFECT Euro **356**

METAL
 M79 Aluminium MMKVTA79
 M73 Titanium MMKVTA73

GRANITEK NATURAL GRANITE EFFECT Euro **356**

MATT
 G68 Bianco MGKVTA68
 G48 Cemento MGKVTA48
 G43 Tortora MGKVTA43
 G40 Nero MGKVTA40

ATHENA

Miscelatore monocomando con canna girevole



CARATTERISTICHE

Dimensioni Foro (ømm) **35**
 Base (mm) **48**
 Rotazione Canna **360°**
 Flessibile **Inox 3/8"**
 Cartuccia (ømm) **25**

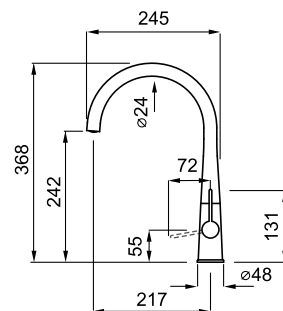

COLORI ABBINABILI

CROMATO Euro **279**
 CR Cromato MIKATH96

GRANITEK NATURAL GRANITE EFFECT Euro **363**

METAL
 M79 Aluminium MMKATH79
 M73 Titanium MMKATH73

GRANITEK NATURAL GRANITE EFFECT Euro **363**

MATT
 G68 Bianco MGKATH68
 G48 Cemento MGKATH48
 G43 Tortora MGKATH43
 G40 Nero MGKATH40

Miscelatore: **Athena M79 Aluminium**
Lavello: **Unico 410 M79 Aluminium**



BRIDGE

Miscelatore monocomando con canna girevole



CARATTERISTICHE

Dimensioni Foro (ømm) 35
 Base (mm) 50
 Rotazione Canna 360°
 Flessibile
 Cartuccia (ømm) 35

35
 50
 360°
 Inox 3/8"
 35

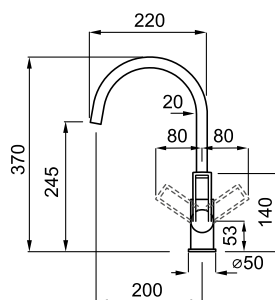

COLORI ABBINABILI

- CROMATO** Euro **243**
- CR Cromato MIKBRICR
- KERATEK^{plus}**
CERAMIC NANOTECHNOLOGY CNE Euro **281**
- K96 White MKKBRI96
 - K86 Black MKKBRI86

- GRANITEK**
NATURAL GRANITE EFFECT Euro **281**
- METAL**
- M79 Aluminium MMKBRI79
 - M73 Titanium MMKBRI73

- GRANITEK**
NATURAL GRANITE EFFECT Euro **281**
- MATT**
- G68 Bianco MGKBRI68
 - G48 Cemento MGKBRI48
 - G43 Tortora MGKBRI43
 - G40 Nero MGKBRI40
- CLASSIC**
- G51 Avena MGKBRI51

CLOUD

Miscelatore monocomando con canna girevole



CARATTERISTICHE

Dimensioni Foro (ømm) 35
 Rotazione Canna 360°
 Flessibile
 Cartuccia (ømm) 35

35
 360°
 Inox 3/8"
 35

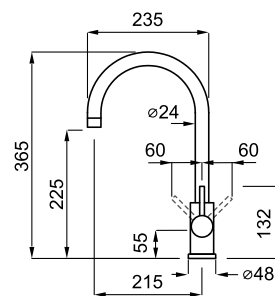

COLORI ABBINABILI

- CROMATO** Euro **193**
- CR Cromato MIKCLOCR
- KERATEK^{plus}**
CERAMIC NANOTECHNOLOGY CNE Euro **244**
- K99 Dark Grey MKKCLO99
 - K97 Light Grey MKKCLO97
 - K96 White MKKCLO96
 - K95 Champagne MKKCLO95
 - K93 Dove Grey MKKCLO93
 - K86 Black MKKCLO86

- GRANITEK**
NATURAL GRANITE EFFECT Euro **244**
- METAL**
- M79 Aluminium MMKCLO79
 - M78 Espresso MMKCLO78
 - M73 Titanium MMKCLO73
 - M70 Ghisa MMKCLO70

- GRANITEK**
NATURAL GRANITE EFFECT Euro **244**
- MATT**
- G68 Bianco MGKCLO68
 - G48 Cemento MGKCLO48
 - G43 Tortora MGKCLO43
 - G40 Nero MGKCLO40
- CLASSIC**
- G62 Bianco Antico MGKCLO62
 - G59 Antracite MGKCLO59
 - G51 Avena MGKCLO51

Miscelatore: **Cloud G59 Antracite**
Lavello: **Unico 410 G59 Antracite**



MISCELATORI

SENNA

Miscelatore monocomando con canna girevole



CARATTERISTICHE

Dimensioni Foro (ømm) 35
 Base (mm) 54
 Rotazione Canna 360°
 Flessibile
 Cartuccia (ømm) 35

35
 54
 360°
 Inox 3/8"
 35

COLORI ABBINABILI

- CROMATO** Euro 167
 ● CR Cromato MIKSENCR
- GRANITEK**
NATURAL GRANITE EFFECT
- MATT**
- G68 Bianco MGKSEN68
 - G40 Nero MGKSEN40
- CLASSIC**
- G62 Bianco Antico MGKSEN62
 - G59 Antracite MGKSEN59
 - G55 Grigio Pietra MGKSEN55
 - G54 Nero Pietra MGKSEN54
 - G52 Bianco Pietra MGKSEN52
 - G51 Avena MGKSEN51

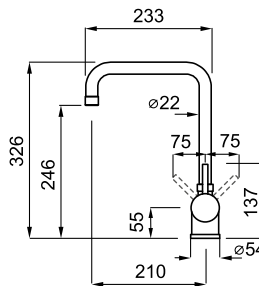

NEVA

Miscelatore monocomando con canna girevole e doccetta estraibile



CARATTERISTICHE

Dimensioni Foro (ømm) 35
 Base (mm) 50
 Rotazione Canna 360°
 Flessibile
 Cartuccia (ømm) 35

35
 50
 360°
 Inox 3/8"
 35

COLORI ABBINABILI

- INOX** Euro 318
 ● IN Inox MIKNEVIN
- OTTONE** Euro 403
 ● OT Ottone MIKNEVOT



GRANITEK
NATURAL GRANITE EFFECT Euro 318

- MATT**
- G68 Bianco MGKNEV68
 - G40 Nero MGKNEV40
- CLASSIC**
- G62 Bianco Antico MGKNEV62
 - G59 Antracite MGKNEV59
 - G51 Avena MGKNEV51

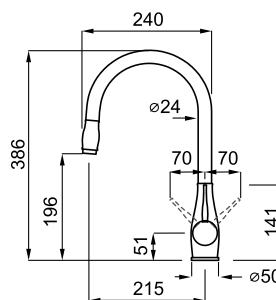

Miscelatore: Neva IN Inox
Lavello: Zen 105 K93 Dove Grey



RIO

Miscelatore monocomando con canna girevole

CARATTERISTICHE

Dimensioni Foro (ømm) 35
Base (mm) 54
Rotazione Canna 360°
Flessibile
Cartuccia (ømm) 40

35
54
360°
Inox 3/8"
40

COLORI ABBINABILI

- CROMATO** Euro 303
● CR Cromato MIKRIOCR
- RAME** Euro 323
● CU Rame MIKRIORA
- OTTONE** Euro 323
● OT Ottone MIKRIOOT

GRANITEK
NATURAL GRANITE EFFECT Euro 323

- CLASSIC
- G62 Bianco Antico MGKRIO62
● G59 Antracite MGKRIO59
● G51 Avena MGKRIO51

ACCESSORIO

Kit Particolari
Ottone Rio

AKRRIOOT
Euro 30

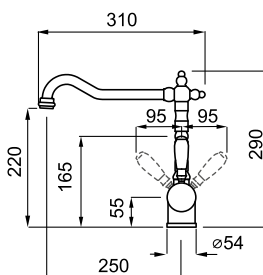

ELBA

Miscelatore doppio comando con canna girevole

CARATTERISTICHE

Dimensioni Foro (ømm) 35
Rotazione Canna 360°
Flessibile

35
360°
Inox 3/8"

COLORI ABBINABILI

- CROMATO** Euro 153
● CR Cromato MIKELBCR
- GRANITEK**
NATURAL GRANITE EFFECT Euro 198
- CLASSIC
- G62 Bianco Antico MGKELB62
● G51 Avena MGKELB51

ACCESSORIO

Kit Particolari
Ottone Elba

AKRELBOT
Euro 18

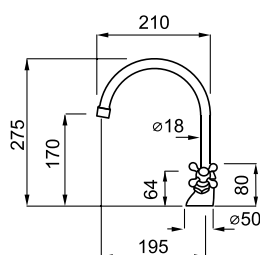

Miscelatore: Rio OT Ottone
 Lavello: Fox 360 G51 Avena



MISCELATORI

PO

Miscelatore monocomando con canna girevole

CARATTERISTICHE

Dimensioni Foro (ømm)
 Rotazione Canna
 Flessibile
 Cartuccia (ømm)

35
 360°
 Inox 3/8"
 40

COLORI ABBINABILI

CROMATO Euro **182**
 ● CR Cromato MIKPOCR

GRANITEK
 NATURAL GRANITE EFFECT Euro **205**
METAL
 ● M79 Aluminium MMKPO79
 ● M73 Titanium MMKPO73

GRANITEK
 NATURAL GRANITE EFFECT Euro **205**

MATT
 ○ G68 Bianco MGKPO68
 ● G40 Nero MGKPO40

CLASSIC
 ● G62 Bianco Antico MGKPO62
 ● G59 Antracite MGKPO59
 ● G55 Grigio Pietra MGKPO55
 ● G54 Nero Pietra MGKPO54
 ● G52 Bianco Pietra MGKPO52
 ● G51 Avena MGKPO51

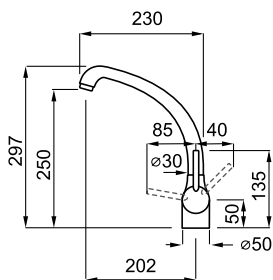

RENO

Miscelatore monocomando con canna girevole e doccetta estraibile

CARATTERISTICHE

Dimensioni Foro (ømm) 35
 Base (mm) 50
 Rotazione Canna 360°
 Flessibile Inox 3/8"
 Cartuccia (ømm) 35

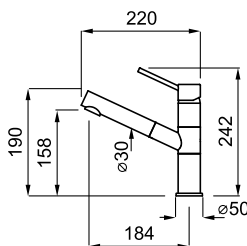

COLORI ABBINABILI

CROMATO

CR Cromato Euro 276

MIKRENCR



K96 White Euro 328

MKKREN96

K86 Black MKKREN86



Euro 328

METAL

M79 Aluminium MMKREN79

M78 Espresso MMKREN78

M73 Titanium MMKREN73

M70 Ghisa MMKREN70



Euro 328

MATT

G68 Bianco MGKREN68

G48 Cemento MGKREN48

G43 Tortora MGKREN43

G40 Nero MGKREN40

CLASSIC

G62 Bianco Antico MGKREN62

G59 Antracite MGKREN59

G51 Avena MGKREN51

SAVA

Miscelatore monocomando con canna girevole

CARATTERISTICHE

Dimensioni Foro (ømm) 35
 Base (mm) 50
 Rotazione Canna 360°
 Flessibile Inox 3/8"
 Cartuccia (ømm) 35

35

50

360°

Inox 3/8"

35

COLORI ABBINABILI

CROMATO

CR Cromato Euro 221

MIKSAVCR



K96 White Euro 269

MKKSAV96

K86 Black MKKSAV86



Euro 269

METAL

M79 Aluminium MMKSAV79

M78 Espresso MMKSAV78

M73 Titanium MMKSAV73

M70 Ghisa MMKSAV70



Euro 269

MATT

G68 Bianco MGKSAV68

G48 Cemento MGKSAV48

G43 Tortora MGKSAV43

G40 Nero MGKSAV40

CLASSIC

G62 Bianco Antico MGKSAV62

G59 Antracite MGKSAV59

G51 Avena MGKSAV51

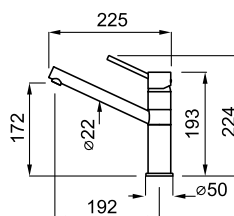

Miscelatore: Reno G51 Avena
Lavello: Fox 360 G51 Avena



VENERE

Miscelatore monocomando con canna girevole e doccetta estraibile con cambio getto

CARATTERISTICHE

Dimensioni Foro (ømm) 35
 Base (mm) 55
 Rotazione Canna 360°
 Flessibile
 Cartuccia (ømm) 40



35
 55
 360°
 Inox 3/8"
 40

COLORI ABBINABILI

- CROMATO** Euro 146
- CR Cromato MIKVENCR
- GRANITEK**
NATURAL GRANITE EFFECT Euro 183
- METAL**
- M79 Aluminium MMKVEN79
 - M73 Titanium MMKVEN73

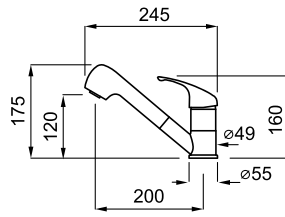

GRANITEK
NATURAL GRANITE EFFECT Euro 183

- MATT**
- G68 Bianco MGKVEN68
- CLASSIC**
- G62 Bianco Antico MGKVEN62
 - G59 Antracite MGKVEN59
 - G54 Nero Pietra MGKVEN54
 - G52 Bianco Pietra MGKVEN52
 - G51 Avena MGKVEN51



MINERVA

Miscelatore monocomando con canna girevole

CARATTERISTICHE

Dimensioni Foro (ømm) **35**
 Base (mm) **50**
 Rotazione Canna **360°**
 Flessibile **Inox 3/8"**
 Cartuccia (ømm) **40**

COLORI ABBINABILI

CROMATO Euro **100**
 ● CR Cromato MIKMINCR
GRANITEK Euro **139**
NATURAL GRANITE EFFECT
METAL
 ● M79 Aluminium MMKMIN79
 ● M73 Titanium MMKMIN73

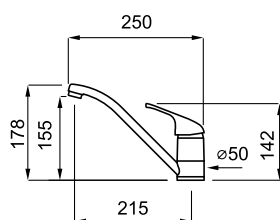

GRANITEK Euro **139**
NATURAL GRANITE EFFECT

MATT
 ○ G68 Bianco MGKMIN68
 ● G40 Nero MGKMIN40
CLASSIC
 ● G62 Bianco Antico MGKMIN62
 ● G59 Antracite MGKMIN59
 ● G54 Nero Pietra MGKMIN54
 ● G52 Bianco Pietra MGKMIN52
 ● G51 Avena MGKMIN51

MINERVA 35

Miscelatore monocomando con canna girevole

CARATTERISTICHE

Dimensioni Foro (ømm) **35**
 Base (mm) **47**
 Rotazione Canna **360°**
 Flessibile **Inox 3/8"**
 Cartuccia (ømm) **35**

COLORI ABBINABILI

CROMATO Euro **78**
 ● CR Cromato MIK35CR
GRANITEK Euro **98**
NATURAL GRANITE EFFECT
MATT
 ○ G68 Bianco MGKM3568
 ● G40 Nero MGKM3540
CLASSIC
 ● G51 Avena MGKM3551

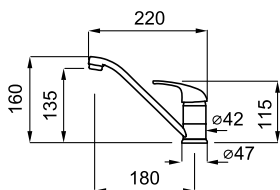

SUITE

LEAF BLACK

Elettrodomestici
abbinabili al colore



K86 BLACK



FORNI

LEAF TOUCH

PAG. 234



NEW

LEAF PLUS

PAG. 235



NEW

LEAF

PAG. 236



NEW

PIANI INDUZIONE

LEAF INDUCTION 80

PAG. 244

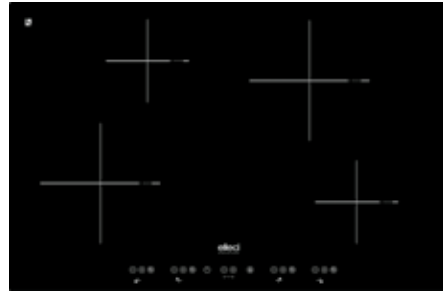

LEAF INDUCTION 60

PAG. 244



LEAF INDUCTION 30

PAG. 245

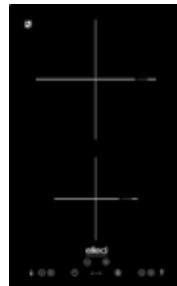

L'eleganza intramontabile del vetro nero è il tratto caratterizzante di tutti gli elettrodomestici della Suite LEAF BLACK. I forni si abbinano perfettamente con i performanti piani a induzione, così come con i piani Gas on Glass dove le griglie in ghisa esaltano l'accoppiamento estetico con la scocca in cristallo temperato. Completano la suite le due cappe aspiranti, tra cui la Vertical spicca per l'accoppiata vetro nero opaco e lucido.

PIANI A GAS

LEAF GAS ON GLASS 70

PAG. 246



LEAF GAS ON GLASS 60

PAG. 247



CAPPE

LEAF VERTICAL

PAG. 260



LEAF BOX

PAG. 260

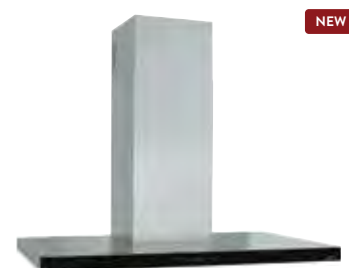

SUITE

LEAF WHITE

Elettrodomestici
abbinabili al colore



K96 WHITE



FORNI

LEAF TOUCH

Pag. 234



NEW

PIANI INDUZIONE

LEAF INDUCTION 80

Pag. 244



LEAF INDUCTION 60

Pag. 244



Il vetro bianco è l'indiscusso protagonista degli elettrodomestici della Suite LEAF WHITE, e conferisce un aspetto molto luminoso e raffinato all'ambiente cucina. Il forno Leaf Touch si abbina perfettamente con i piani a induzione, e con i piani Gas on Glass dove si esalta l'accoppiamento estetico con la scocca in cristallo temperato. Completano la suite le due cappe aspiranti, tra cui la Vertical spicca per l'accoppiata vetro bianco opaco e lucido.

PIANI A GAS

LEAF GAS ON GLASS 90

Pag. 246



LEAF GAS ON GLASS 70

Pag. 246



LEAF GAS ON GLASS 60

Pag. 247



CAPPE

LEAF VERTICAL

Pag. 260



LEAF BOX

Pag. 260



SUITE

PLANO

Elettrodomestici
abbinabili al colore

FORNI

PLANO TOUCH

Pag. 237



NEW

- K86
- G40
- K96
- G68
- K97
- K93

PLANO PLUS

Pag. 238



- K86
- G40
- M79
- M73
- K96
- G68
- G51
- G43
- K97
- K93
- IN

PLANO

Pag. 239



- G40
- M79
- M73
- G68
- G51
- G43
- IN

PIANI A GAS

PLANO PLUS 75

Pag. 248



NEW

- K86
- G40
- K96
- G68
- K97
- K93

PLANO 90

Pag. 254



- G40
- G68

FORNO MICROONDE

Pag. 241



- K86
- G40
- M79
- M73
- K96
- G68
- G51
- G43
- K97
- K93
- IN

La Suite Plano è la più versatile e offre infinite possibilità di combinare i diversi elettrodomestici, con la certezza di avere sempre un ideale abbinamento cromatico tra loro e con i lavelli Elleci. La consueta cura del dettaglio è testimoniata dai processi tecnici di verniciatura e smaltatura degli elementi metallici, creando family feeling. Inoltre, nella Suite Plano, spiccano le due novità di prodotto: il Forno Plano Touch, classe A+ e cavità di 78 litri e il Piano Cottura Plano Plus 75, caratterizzato dai bruciatori Flat Burner e dal sistema Flame Step Control, che permette di poter regolare con precisione 9 livelli di potenza della fiamma.

PIANI A GAS

PLANO 75

Pag. 250



- G40
- M79
- M73
- G68
- G51
- G43
- IN

PLANO 60

Pag. 252



- G40
- M79
- M73
- G68
- G51
- G43
- IN

CAPPE

BRIO

Pag. 261



NEW

BK

URBAN

Pag. 261



NEW

BK

SUITE

STYLE

Elettrodomestici
abbinabili al colore

FORNI

STYLE

Pag. 240



NEW

G68

G51

G59

G48

PIANI A GAS

STYLE 90

Pag. 255



G51

FORNO MICROONDE

Pag. 241



G68

G51

G59

G48

Le cucine dall'estetica classica e country, caratterizzate da colori caldi ed accoglienti e dalla presenza del legno, sono l'ambiente ideale per accogliere gli elettrodomestici della Suite Style. Anche in questo caso, il processo tecnico di verniciatura e smaltatura degli elementi metallici dimostra la cura di Elleci nel creare il corretto bilanciamento cromatico.

PIANI A GAS

STYLE 75

Pag. 256



NEW

G68

G51

G59

G48

STYLE 60

Pag. 258



NEW

G68

G51

G59

G48

CAPPE

BRIO

Pag. 261



NEW

BK

URBAN

Pag. 261



NEW

BK

FORNI



DISPLAY IMAGO



Con il display IMAGO è semplice impostare e visualizzare funzione, temperatura e tempo di cottura. Il controllo elettronico permette la massima precisione nel raggiungere e mantenere la temperatura impostata.

DISPLAY LED



Tutti i tempi, le funzioni e le temperature di cottura sono riassunte nel comodo e pratico display led e le impostazioni avvengono con estrema semplicità attraverso le manopole. La temperatura selezionata è raggiunta e mantenuta grazie al controllo elettronico.

CAVITÀ XL



Con la sua generosa capacità interna, la cavità del forno offre il 35% di spazio in più rispetto a un forno tradizionale, mantenendo le stesse dimensioni esterne.

STEAM CLEAN



La funzione Steam Clean sfrutta l'azione del vapore per rimuovere con facilità i residui di grasso dal forno.

GUIDA TELESCOPICA ESTRAIBILE



Per ottimizzare l'utilizzo del forno, la guida telescopica permette di inserire ed estrarre la teglia con maggiore facilità. Questo accorgimento garantisce la massima sicurezza, evitando l'inserimento della mano nel forno.

Per ottimizzare l'utilizzo del forno, la guida telescopica permette di inserire ed estrarre la teglia con maggiore facilità. Questo accorgimento garantisce la massima sicurezza, evitando l'inserimento della mano nel forno.

COLD DOOR



Il calore viene trattenuto all'interno del forno, grazie all'eccellente sistema di raffreddamento interno. La temperatura della porta diminuisce evitando possibili scottature e il calore prodotto viene così sfruttato totalmente per la cottura.

Il calore viene trattenuto all'interno del forno, grazie all'eccellente sistema di raffreddamento interno. La temperatura della porta diminuisce evitando possibili scottature e il calore prodotto viene così sfruttato totalmente per la cottura.

VETRO PORTA REMOVIBILE



La superficie completamente liscia e senza viti, facilita la rimozione dello sporco, ed il vetro della controporta è facilmente rimovibile per consentire una pulizia più efficace e veloce, senza rimuovere l'intera controporta.

MICROONDE

CAVITÀ INTERNA IN ACCIAIO INOSSIDABILE



L'ampia cavità in acciaio inossidabile da 28 litri permette di alloggiare un piatto girevole da 315 mm di diametro, lo spazio ideale per ogni tipo di ricetta.

10 MENÙ AUTOMATICI DI COTTURA



10 menù automatici di cottura a tua disposizione, semplicemente ruotando la manopola principale. La fantasia non ha davvero più limiti: pizza, pasta, carne, pesce, verdure.

LEAF TOUCH



NEW

CLASSE **A+**
78
LITRI

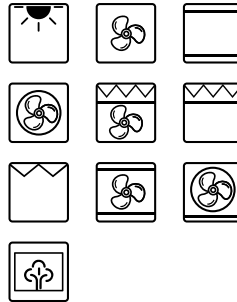

Forno elettrico multifunzione 10 Funzioni

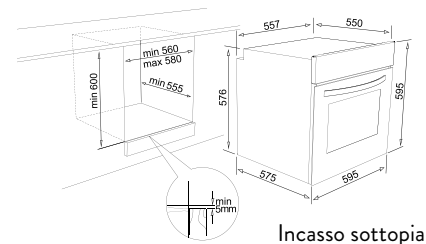

Incasso sottopiano

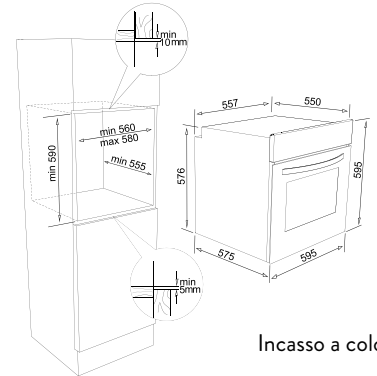

Incasso a colonna

CARATTERISTICHE

Dimensioni (mm)	595 x 595 x 575
Incasso a colonna (mm)	da disegno
Incasso sottopiano (mm)	da disegno
Profondità porta aperta (mm)	480
Carico elettrico totale (Watt)	2300
Tensione (v)	220
Lunghezza cavo alimentazione (mm)	150

ESTETICA FORNO IN VETRO ABBINABILE AI COLORI

KERATEK plus
CERAMIC NANOTECHNOLOGY CNB

Euro **1091**

○ K96 White

FKVQ60296NS

● K86 Black

FKVQ60286NS

SPECIFICHE

- Classe Energetica A+
- Vano cottura XL 78 Litri
- Programmatore elettronico con Display Led IMAGO
- Funzione pulizia Steam Clean
- Ventilazione radiale di raffreddamento porta
- Controporta full vetro con vetro removibile
- Cavità con smalto Easy Clean
- Maniglia silver
- Temperatura massima 275°C

Dotazione: Griglia con guida telescopica, leccarda e recipiente per funzione Steam Clean.

DISPLAY IMAGO



Con il display IMAGO è semplice impostare e visualizzare funzione, temperatura e tempo di cottura. Il controllo elettronico permette la massima precisione nel raggiungere e mantenere la temperatura impostata.

CAVITÀ XL



Con i suoi 78 litri di capacità interna, la cavità del forno offre il 30% di spazio in più rispetto a un forno tradizionale, mantenendo le stesse dimensioni esterne.

STEAM CLEAN



La funzione Steam Clean sfrutta l'azione del vapore per rimuovere con facilità i residui di grasso dal forno.

GUIDA TELESCOPICA ESTRAIBILE



Per ottimizzare l'utilizzo del forno, la guida telescopica permette di inserire ed estrarre la teglia con maggiore facilità. Questo accorgimento garantisce la massima sicurezza, evitando l'inserimento della mano nel forno.

COLD DOOR



Il calore viene trattenuto all'interno del forno, grazie all'eccellente sistema di raffreddamento interno. La temperatura della porta diminuisce evitando possibili scottature e il calore prodotto viene così sfruttato totalmente per la cottura.

VETRO PORTA REMOVIBILE



La superficie completamente liscia e senza viti, facilita la rimozione dello sporco, ed il vetro della controporta è facilmente removibile per consentire una pulizia più efficace e veloce, senza rimuovere l'intera controporta.

LEAF PLUS



NEW

CLASSE
A+

78
LITRI

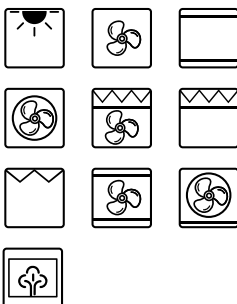

Forno elettrico multifunzione 10 Funzioni

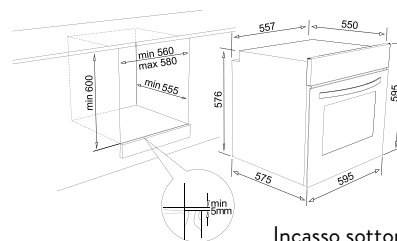

Incasso sottopiano

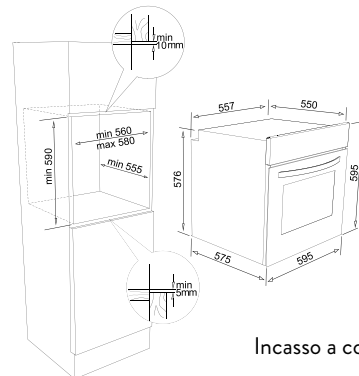

Incasso a colonna

CARATTERISTICHE

Dimensioni (mm)	595 x 595 x 575
Incasso a colonna (mm)	da disegno
Incasso sottopiano (mm)	da disegno
Profondità porta aperta (mm)	480
Carico elettrico totale (Watt)	2300
Tensione (v)	220
Lunghezza cavo alimentazione (mm)	150

ESTETICA FORNO IN VETRO ABBINABILE AI COLORI

KERATEK plus
CERAMIC NANOTECHNOLOGY CNB

Euro **869**

● K86 Black

FKLP60286NS

SPECIFICHE

Classe Energetica A+
Vano cottura XL 78 Litri
Programmatore elettronico con Display Led
Funzione pulizia Steam Clean
Ventilazione radiale di raffreddamento porta
Controporta full vetro con vetro removibile
Cavità con smalto Easy Clean
Manopole flat e maniglia silver
Temperatura massima 275°C

Dotazione: Griglia, leccarda e recipiente per funzione Steam Clean.

DISPLAY LED



Tutti i tempi, le funzioni e le temperature di cottura sono riassunte nel comodo e pratico display led e le impostazioni avvengono con estrema semplicità attraverso le manopole. La temperatura selezionata è raggiunta e mantenuta grazie al controllo elettronico.

CAVITÀ XL



Con i suoi 78 litri di capacità interna, la cavità del forno offre il 30% di spazio in più rispetto a un forno tradizionale, mantenendo le stesse dimensioni esterne.

STEAM CLEAN



La funzione Steam Clean sfrutta l'azione del vapore per rimuovere con facilità i residui di grasso dal forno.

COLD DOOR



Il calore viene trattenuto all'interno del forno, grazie all'eccellente sistema di raffreddamento interno. La temperatura della porta diminuisce evitando possibili scottature e il calore prodotto viene così sfruttato totalmente per la cottura.

VETRO PORTA REMOVIBILE



La superficie completamente liscia e senza viti, facilita la rimozione dello sporco, ed il vetro della controporta è facilmente removibile per consentire una pulizia più efficace e veloce, senza rimuovere l'intera controporta.



NEW

CLASSE
A

73
LITRI

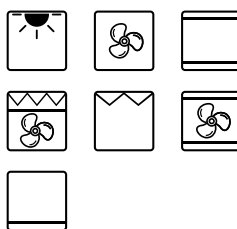

Forno elettrico multifunzione 7 Funzioni

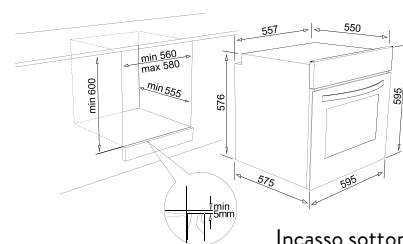

Incasso sottopiano

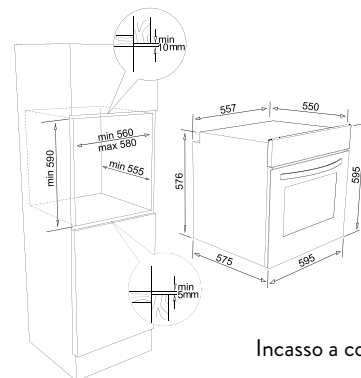

Incasso a colonna

CARATTERISTICHE

Dimensioni (mm)	595 x 595 x 575
Incasso a colonna (mm)	da disegno
Incasso sottopiano (mm)	da disegno
Profondità porta aperta (mm)	480
Carico elettrico totale (Watt)	2300
Tensione (v)	220
Lunghezza cavo alimentazione (mm)	150

ESTETICA FORNO IN VETRO ABBINABILE AI COLORI

KERATEK plus
CERAMIC NANOTECHNOLOGY CMB

Euro **652**

● K86 Black

FKLE60286NS

SPECIFICHE

- Classe Energetica A
- Vano cottura XL 73 Litri
- Ventilazione radiale di raffreddamento porta
- Controporta full vetro con vetro removibile
- Cavità con smalto Easy Clean
- Manopole flat e maniglia silver

Dotazione: Griglia e leccarda.

CAVITÀ XL



Con i suoi 78 litri di capacità interna, la cavità del forno offre il 30% di spazio in più rispetto a un forno tradizionale, mantenendo le stesse dimensioni esterne.

COLD DOOR



Il calore viene trattenuto all'interno del forno, grazie all'eccellente sistema di raffreddamento interno. La temperatura della porta diminuisce evitando possibili scottature e il calore prodotto viene così sfruttato totalmente per la cottura.

VETRO PORTA REMOVIBILE



La superficie completamente liscia e senza viti, facilita la rimozione dello sporco, ed il vetro della controporta è facilmente removibile per consentire una pulizia più efficace e veloce, senza rimuovere l'intera controporta.

PLANO TOUCH



NEW

CLASSE **A+** **78** LITRI

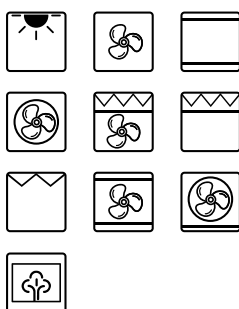

Forno elettrico multifunzione 10 Funzioni

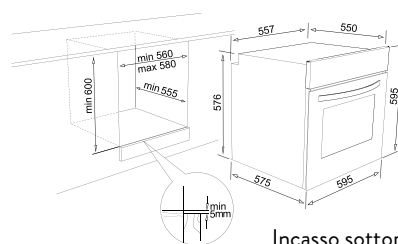

Incasso sottopiano

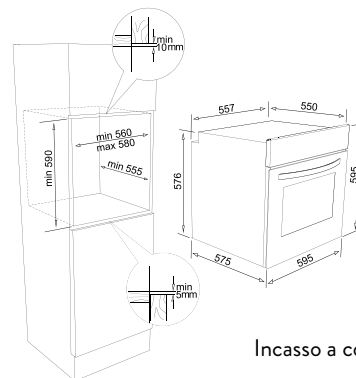

Incasso a colonna

CARATTERISTICHE

Dimensioni (mm)	595 x 595 x 575
Incasso a colonna (mm)	da disegno
Incasso sottopiano (mm)	da disegno
Profondità porta aperta (mm)	480
Carico elettrico totale (Watt)	2300
Tensione (v)	220
Lunghezza cavo alimentazione (mm)	150

ESTETICA FORNO IN VETRO CON CORNICE SMALTATA ABBINABILE AI COLORI

KERATEK plus CERAMIC NANOTECHNOLOGY CN8

Euro **1236**

- K97 Light Grey FKPT60297TO
- K96 White FKPT60296TO
- K93 Dove Grey FKPT60293TO
- K86 Black FKPT60286TO

GRANITEK NATURAL GRANITE EFFECT

Euro **1236**

MATT

- G68 Bianco FGPT60268TO
- G40 Nero FGPT60240TO

SPECIFICHE

- Classe Energetica A+
- Vano cottura XL 78 Litri
- Programmatore elettronico con Display Led IMAGO
- Funzione pulizia Steam Clean
- Ventilazione radiale di raffreddamento porta
- Controporta full vetro con vetro removibile
- Cavità con smalto Easy Clean
- Maniglia silver
- Temperatura massima 275°C

Dotazione: Griglia con guida telescopica, leccarda e recipiente per funzione Steam Clean.

DISPLAY IMAGO



Con il display IMAGO è semplice impostare e visualizzare funzione, temperatura e tempo di cottura. Il controllo elettronico permette la massima precisione nel raggiungere e mantenere la temperatura impostata.

CAVITÀ XL



Con i suoi 78 litri di capacità interna, la cavità del forno offre il 30% di spazio in più rispetto a un forno tradizionale, mantenendo le stesse dimensioni esterne.

STEAM CLEAN



La funzione Steam Clean sfrutta l'azione del vapore per rimuovere con facilità i residui di grasso dal forno.

GUIDA TELESCOPICA ESTRAIBILE



Per ottimizzare l'utilizzo del forno, la guida telescopica permette di inserire ed estrarre la teglia con maggiore facilità. Questo accorgimento garantisce la massima sicurezza, evitando l'inserimento della mano nel forno.

COLD DOOR



Il calore viene trattenuto all'interno del forno, grazie all'eccellente sistema di raffreddamento interno. La temperatura della porta diminuisce evitando possibili scottature e il calore prodotto viene così sfruttato totalmente per la cottura.

VETRO PORTA REMOVIBILE



La superficie completamente liscia e senza viti, facilita la rimozione dello sporco, ed il vetro della controporta è facilmente removibile per consentire una pulizia più efficace e veloce, senza rimuovere l'intera controporta.

PLANO PLUS



CLASSE
A+

78
LITRI

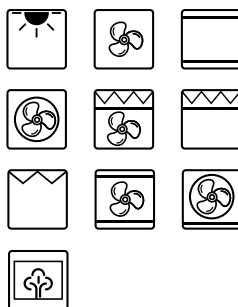

Forno elettrico multifunzione 10 Funzioni

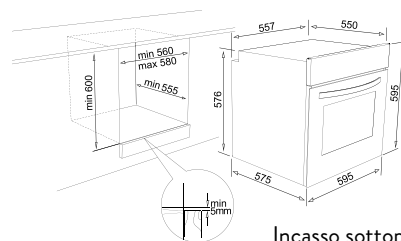

Incasso sottopiano

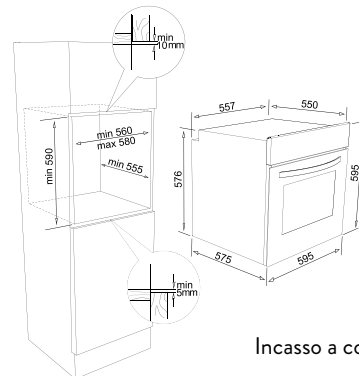

Incasso a colonna

CARATTERISTICHE

Dimensioni (mm)	595 x 595 x 575
Incasso a colonna (mm)	da disegno
Incasso sottopiano (mm)	da disegno
Profondità porta aperta (mm)	480
Carico elettrico totale (Watt)	2300
Tensione (v)	220
Lunghezza cavo alimentazione (mm)	150

SPECIFICHE

Classe Energetica A+
Vano cottura XL 78 litri
Programmatore elettronico con Display Led
Funzione pulizia Steam Clean
Ventilazione radiale di raffreddamento porta
Controporta full vetro con vetro removibile
Cavità con smalto Easy Clean
Manopole flat e maniglia silver
Temperatura massima 275°C

ESTETICA FORNO IN VETRO CON CORNICE SMALTATA ABBINABILE AI COLORI

KERATEK plus
CERAMIC NANOTECHNOLOGY CNB

Euro **942**

● K97 Light Grey	FKPP60297NS
○ K96 White	FKPP60296NS
● K93 Dove Grey	FKPP60293NS
● K86 Black	FKPP60286NS

GRANITEK
NATURAL GRANITE EFFECT

Euro **942**

MATT

○ G68 Bianco	FGPP60268NS
● G43 Tortora	FGPP60243NS
● G40 Nero	FGPP60240NS
● G51 Avena	FGPP60251NS

CLASSIC

GRANITEK
NATURAL GRANITE EFFECT

Euro **942**

METAL

● M79 Aluminium	FMPP60279NS
● M73 Titanium	FMPP60273NS

INOX

Euro **896**

● IN Inox	FIPP602INNS
-----------	-------------

Dotazione: Griglia, leccarda e recipiente per funzione Steam Clean.

DISPLAY LED



Tutti i tempi, le funzioni e le temperature di cottura sono riassunte nel comodo e pratico display led e le impostazioni avvengono con estrema semplicità attraverso le manopole. La temperatura selezionata è raggiunta e mantenuta grazie al controllo elettronico.

CAVITÀ XL



Con i suoi 78 litri di capacità interna, la cavità del forno offre il 30% di spazio in più rispetto a un forno tradizionale, mantenendo le stesse dimensioni esterne.

STEAM CLEAN



La funzione Steam Clean sfrutta l'azione del vapore per rimuovere con facilità i residui di grasso dal forno.

COLD DOOR



Il calore viene trattenuto all'interno del forno, grazie all'eccellente sistema di raffreddamento interno. La temperatura della porta diminuisce evitando possibili scottature e il calore prodotto viene così sfruttato totalmente per la cottura.

VETRO PORTA REMOVIBILE



La superficie completamente liscia e senza viti, facilita la rimozione dello sporco, ed il vetro della controporta è facilmente removibile per consentire una pulizia più efficace e veloce, senza rimuovere l'intera controporta.

PLANO



CLASSE **A** **73** LITRI

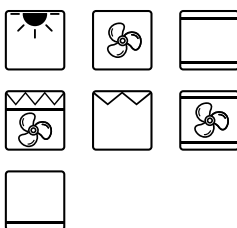

Forno elettrico multifunzione 7 Funzioni

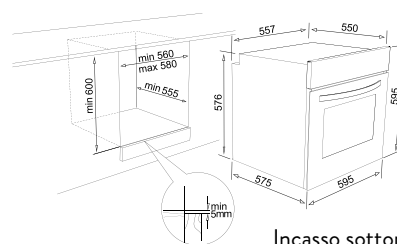

Incasso sottopiano

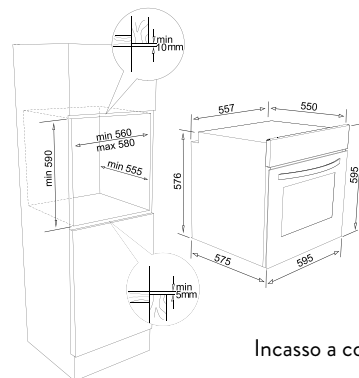

Incasso a colonna

CARATTERISTICHE

Dimensioni (mm)	595 x 595 x 575
Incasso a colonna (mm)	da disegno
Incasso sottopiano (mm)	da disegno
Profondità porta aperta (mm)	480
Carico elettrico totale (Watt)	2300
Tensione (v)	220
Lunghezza cavo alimentazione (mm)	150

SPECIFICHE

Classe Energetica A
 Vano cottura XL 73 Litri
 Ventilazione radiale di raffreddamento porta
 Controporta full vetro con vetro removibile
 Cavità con smalto Easy Clean
 Manopole flat e maniglia silver

ESTETICA FORNO IN VETRO CON CORNICE SMALTATA ABBINABILE AI COLORI

GRANITEK
 NATURAL GRANITE EFFECT

Euro **761**

METAL

- M79 Aluminium FMSP60279NS
- M73 Titanium FMSP60273NS

GRANITEK
 NATURAL GRANITE EFFECT

Euro **761**

MATT

- G68 Bianco FGSP60268NS
- G43 Tortora FGSP60243NS
- G40 Nero FGSP60240NS
- CLASSIC
- G51 Avena FGSP60251NS

INOX

Euro **715**

- IN Inox FIAP602INNS

Dotazione: Griglia e leccarda.

CAVITÀ XL



Con i suoi 73 litri di capacità interna, la cavità del forno offre il 30% di spazio in più rispetto a un forno tradizionale, mantenendo le stesse dimensioni esterne.

COLD DOOR



Il calore viene trattenuto all'interno del forno, grazie all'eccellente sistema di raffreddamento interno. La temperatura della porta diminuisce evitando possibili scottature e il calore prodotto viene così sfruttato totalmente per la cottura.

VETRO PORTA REMOVIBILE



La superficie completamente liscia e senza viti, facilita la rimozione dello sporco, ed il vetro della controporta è facilmente removibile per consentire una pulizia più efficace e veloce, senza rimuovere l'intera controporta.

STYLE



NEW

CLASSE
A

80
LITRI



Forno elettrico multifunzione 6 Funzioni

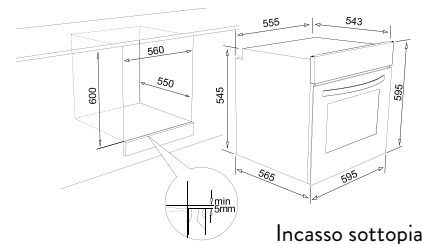

Incasso sottopiano

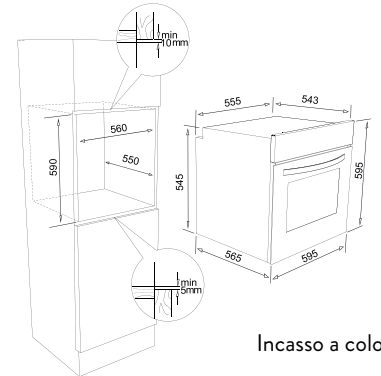

Incasso a colonna

CARATTERISTICHE

Dimensioni (mm)	595 x 595 x 565
Incasso a colonna (mm)	da disegno
Incasso sottopiano (mm)	da disegno
Profondità porta aperta (mm)	480
Carico elettrico totale (Watt)	2300
Tensione (v)	220
Lunghezza cavo alimentazione (mm)	150

ESTETICA FORNO IN VETRO CON CORNICE SMALTATA ABBINABILE AI COLORI

GRANITEK
NATURAL GRANITE EFFECT

Euro **760**

MATT



G68 Bianco

FGST60368NB



G48 Cemento

FGST60348NB

CLASSIC



G59 Antracite

FGST60359NB



G51 Avena

FGST60351NB

SPECIFICHE

Classe Energetica A
Vano cottura XL 80 Litri
Ventilazione radiale di raffreddamento porta
Controporta full vetro con vetro removibile
Cavità con smalto Easy Clean
Manopole flat e maniglia nere

Dotazione: Griglia e leccarda.

CAVITÀ XL



Con i suoi 80 litri di capacità interna, la cavità del forno offre il 35% di spazio in più rispetto a un forno tradizionale, mantenendo le stesse dimensioni esterne.

COLD DOOR



Il calore viene trattenuto all'interno del forno, grazie all'eccellente sistema di raffreddamento interno. La temperatura della porta diminuisce evitando possibili scottature e il calore prodotto viene così sfruttato totalmente per la cottura.

VETRO PORTA REMOVIBILE



La superficie completamente liscia e senza viti, facilita la rimozione dello sporco, ed il vetro della controporta è facilmente removibile per consentire una pulizia più efficace e veloce, senza rimuovere l'intera controporta.

FORNO MICROONDE

Forno a microonde con grill, 10 menù automatici di cottura



28
LITRI

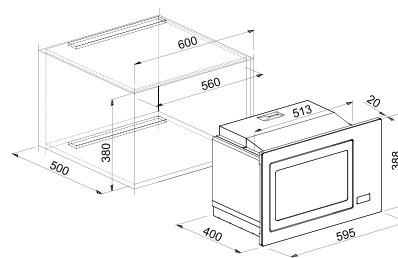

Incasso a colonna

CARATTERISTICHE

Dimensioni (mm)	595 x 388 x 400
Incasso a colonna (mm)	da disegno
Profondità porta aperta (mm)	395
Carico elettrico totale (Watt)	1450
Tensione (v)	230
Lunghezza cavo alimentazione (mm)	100

SPECIFICHE

10 menu di accesso automatico
Scongelamento automatico in base a tempo e peso
Programmatore elettronico con display digitale fino a 95 min.
Pulsante di avvio rapido
Piatto girevole ø315 mm
Cavità interna in acciaio inossidabile
Blocco di sicurezza

ESTETICA FORNO IN VETRO CON CORNICE SMALTATA ABBINABILE AI COLORI

KERATEK plus
CERAMIC NANOTECHNOLOGY CN8

Euro 768	
● K97 Light Grey	FKSP28197WS
○ K96 White	FKSP28196WS
● K93 Dove Grey	FKSP28193WS
● K86 Black	FKSP28186WS

GRANITEK
NATURAL GRANITE EFFECT

Euro 768	
METAL	
● M79 Aluminium	FMSP28179WS
● M73 Titanium	FMSP28173WS

GRANITEK
NATURAL GRANITE EFFECT

Euro 768	
MATT	
○ G68 Bianco	FGSP28168WS
● G48 Cemento	FGSP28148WS
● G43 Tortora	FGSP28143WS
● G40 Nero	FGSP28140WS
CLASSIC	
● G59 Antracite	FGSP28159WS
● G51 Avena	FGSP28151WS

INOX

Euro 657	
● IN Inox	FIAP281INWS

Dotazione: Piatto in vetro e griglia microonde.



PIANI COTTURA

a induzione

TIMER



Programmazione digitale del tempo di cottura con allarme acustico configurabile su ogni singola zona del piano cottura a induzione.

BLOCCO SICUREZZA BAMBINI



Blocco di sicurezza che può essere attivato e disattivato in qualunque momento, per bloccare tutte le funzionalità dei comandi touch.

E-BOOST



Tempi di riscaldamento più brevi e fino al 30% in più di potenza grazie alla funzione Boost utilizzabile su ogni singola zona.

LIMITATORE DI POTENZA



Permette di limitare l'assorbimento elettrico con 3 programmi di configurazione differenti, adattabili a tutte le esigenze casalinghe.

EASY CLEAN



Ogni zona cottura si attiva solo al contatto con la pentola, lasciando il restante piano cottura freddo, questo fa sì che i cibi che fuoriescono non brucino e rimangano facili da pulire.

TOUCH CONTROL PER OGNI ZONA COTTURA



Regola facilmente le impostazioni di temperatura del tuo piano cottura. Ogni zona cottura ha un proprio controllo della potenza, per offrire una chiara visualizzazione e per modificare facilmente le impostazioni della temperatura.



FLAT BURNER



Con la loro particolare forma, i Flat Burners permettono di disperdere meno calore laterale, con migliore efficienza e miglior rendimento nell'erogazione della fiamma.

TRIPLA CORONA



Una tripla corona (3 potenti cerchi di fuoco) è in grado di sviluppare e distribuire in modo omogeneo il calore, riducendo di conseguenza i tempi di cottura. La migliore ripartizione di calore sotto la pentola sfrutta al massimo la potenza e consente una cottura veloce e omogenea.

ACCENSIONE INTEGRATA SOTTOMANOPOLA

È sufficiente premere contemporaneamente ruotare la manopola affinché vengano attivate sia l'erogazione del gas sia le scintille necessarie per accendere il bruciatore.

FLAME STEP CONTROL



Flame Step Control permette di poter regolare con precisione 9 livelli di potenza della fiamma, per un controllo ottimale di tutte le fasi di cottura, importante specialmente nelle regolazioni intermedie.

GRIGLIE IN GHISA

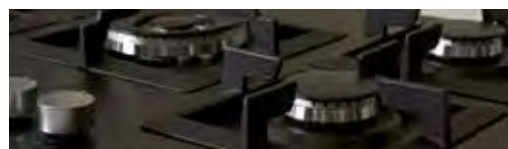

Le griglie, robuste e solide, rivestono un ruolo essenziale nelle fasi della cottura e garantiscono la massima stabilità ad ogni tipo di pentola. L'assenza di spigoli vivi ne facilita la pulizia e grazie alla resistenza del materiale la durata nel tempo è assicurata.

VALVOLA DI SICUREZZA

In caso di spegnimento accidentale della fiamma, il sistema di sicurezza interrompe l'erogazione del gas, garantendo così la massima sicurezza e praticità d'uso.

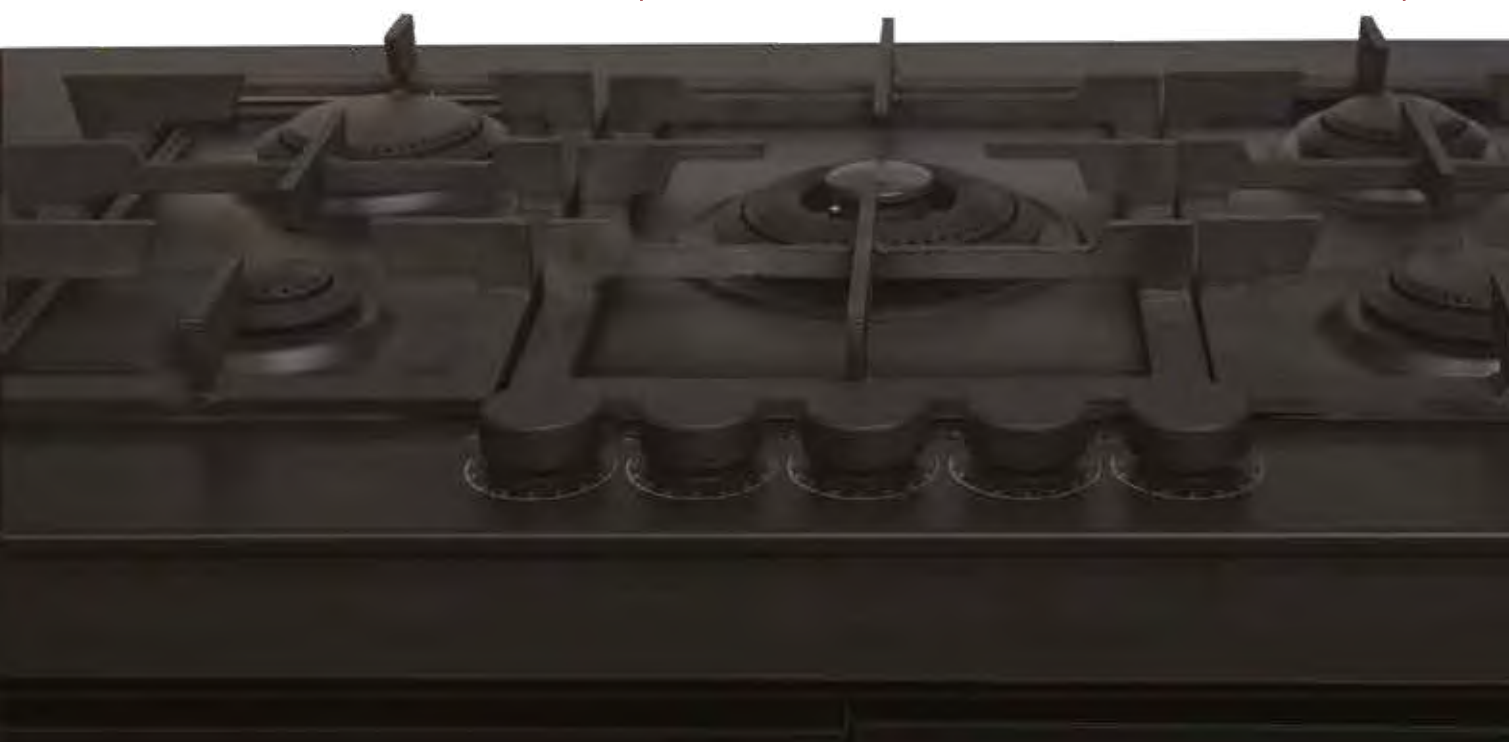

LEAF 80

Induzione in vitroceramica

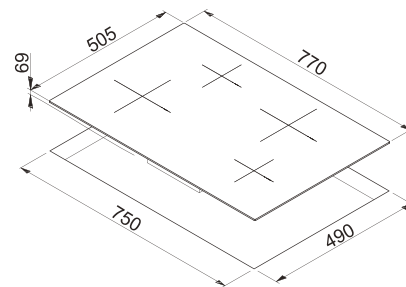
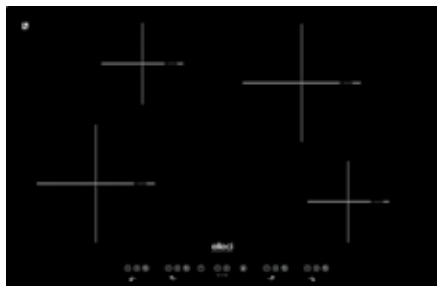

FUNZIONALITÀ



CARATTERISTICHE

Dimensioni (mm)	770 x 505
Foro da Incasso (mm)	750 x 490
Altezza Top (mm)	4
Ingombro Sottopiano (mm)	65

SPECIFICHE

4 zone cottura a induzione
2 zone (Ø 210 mm, 1500W) con Booster (2000W),
2 zone (Ø 145 mm, 1200W) con Booster (1600W)
Comandi Touch per ogni zona cottura a 9 livelli di potenza
Programmazione digitale del tempo di cottura (99 min)
Limitatore di potenza programmabile su 3 livelli
Funzione cronometro con allarme acustico
Indicatori di calore residuo e blocco sicurezza bambini
Potenza massima assorbita: 7200W (o 2800W o 3500W o 6000W)

PIANO COTTURA IN VETROCERAMICA ABBINABILE AI COLORI

KERATEK Plus Euro **1385**
CERAMIC NANOTECHNOLOGY CN8

○ K96 White PKIL80196

KERATEK Plus Euro **1160**
CERAMIC NANOTECHNOLOGY CN8

● K86 Black PKIL80186

LEAF 60

Induzione in vitroceramica

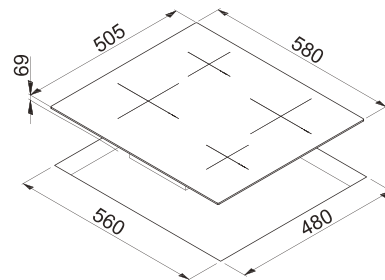

FUNZIONALITÀ



CARATTERISTICHE

Dimensioni (mm)	580 x 505
Foro da Incasso (mm)	560 x 480
Altezza Top (mm)	4
Ingombro Sottopiano (mm)	65

SPECIFICHE

4 zone cottura a induzione
2 zone (Ø 210 mm, 1500W) con Booster (2000W),
2 zone (Ø 145 mm, 1200W) con Booster (1600W)
Comandi Touch per ogni zona cottura a 9 livelli di potenza
Programmazione digitale del tempo di cottura (99 min)
Limitatore di potenza programmabile su 3 livelli
Funzione cronometro con allarme acustico
Indicatori di calore residuo e blocco sicurezza bambini
Potenza massima assorbita: 7200W (o 2800W o 3500W o 6000W)

PIANO COTTURA IN VETROCERAMICA ABBINABILE AI COLORI

KERATEK Plus Euro **1183**
CERAMIC NANOTECHNOLOGY CN8

○ K96 White PKIL60196

KERATEK Plus Euro **981**
CERAMIC NANOTECHNOLOGY CN8

● K86 Black PKIL60186

LEAF 30

Induzione in vitroceramica

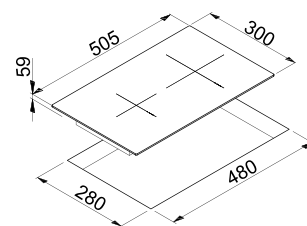
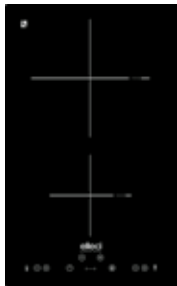

FUNZIONALITÀ



PIANO COTTURA IN VETROCERAMICA ABBINABILE AI COLORI

KERATEK plus
CERAMIC NANOTECHNOLOGY CMB

Euro **692**

● K86 Black

PKIL30186

CARATTERISTICHE

Dimensioni (mm)	300 x 505
Foro da Incasso (mm)	280 x 480
Altezza Top (mm)	4
Ingombro Sottopiano (mm)	55

SPECIFICHE

2 zone cottura a induzione
1 zone (Ø 210 mm, 1500W) con Booster (2000W),
1 zone (Ø 145 mm, 1200W) con Booster (1600W)
Comandi Touch per ogni zona cottura a 9 livelli di potenza
Programmazione digitale del tempo di cottura (99 min)
Limitatore di potenza programmabile su 3 livelli
Funzione cronometro con allarme acustico
Indicatori di calore residuo e blocco sicurezza bambini
Potenza massima assorbita: 3600W (o 1600W o 2000W)

E-BOOST



Tempi di riscaldamento più brevi e fino al 30% in più di potenza grazie alla funzione Boost utilizzabile su ogni singola zona.

LIMITATORE DI POTENZA



Permette di limitare l'assorbimento elettrico con 3 programmi di configurazione differenti, adattabili a tutte le esigenze casalinghe.

TOUCH CONTROL PER OGNI ZONA COTTURA



Regola facilmente le impostazioni di temperatura del tuo piano cottura. Ogni zona cottura ha un proprio controllo della potenza, per offrire una chiara visualizzazione e per modificare facilmente le impostazioni della temperatura.

TIMER



Programmazione digitale del tempo di cottura con allarme acustico configurabile su ogni singola zona del piano cottura a induzione.

EASY CLEAN



Ogni zona cottura si attiva solo al contatto con la pentola, lasciando il restante piano cottura freddo, questo fa sì che i cibi che fuoriescono non brucino e rimangano facili da pulire.

BLOCCO DI SICUREZZA BAMBINI



Blocco di Sicurezza che può essere attivato e disattivato in qualunque momento, per bloccare tutte le funzionalità dei comandi touch.

LEAF GAS ON GLASS 90

Piano a gas da incasso in cristallo temperato

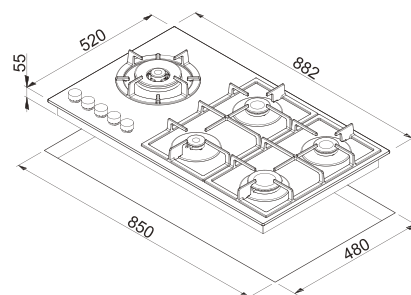

PIANO COTTURA IN VETRO ABBINABILE AI COLORI

KERATEK plus
CERAMIC NANOTECHNOLOGY CNB

Euro **1103**

○ K96 White

PKCQ90296DS

FUNZIONALITÀ



CARATTERISTICHE

Dimensioni (mm)	882 x 520
Foro da Incasso (mm)	850 x 480
Altezza Top (mm)	8
Ingombro Sottopiano (mm)	47

SPECIFICHE

5 fuochi a gas, di cui un tripla corona laterale
1 Tripla Corona 4,5 kW; 1 Rapido 3 kW; 2 Semirapido 1,75 kW; 1 Ausiliario 1 kW
Accensione integrata nella manopola
Valvola di sicurezza
Griglie e coprispartifiamma in ghisa
Manopole flat silver

LEAF GAS ON GLASS 70

Piano a gas da incasso in cristallo temperato

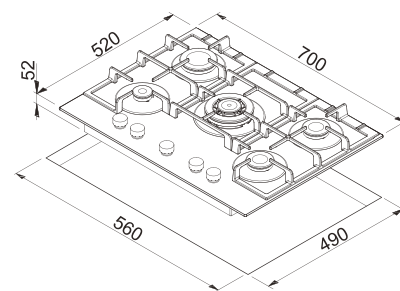

PIANO COTTURA IN VETRO ABBINABILE AI COLORI

KERATEK plus
CERAMIC NANOTECHNOLOGY CNB

Euro **890**

○ K96 White

PKCQ70296CS

● K86 Black

PKCQ70286CS

FUNZIONALITÀ



CARATTERISTICHE

Dimensioni (mm)	700 x 520
Foro da Incasso (mm)	560 x 490
Altezza Top (mm)	8
Ingombro Sottopiano (mm)	44

SPECIFICHE

5 fuochi a gas, di cui un tripla corona centrale
1 Tripla Corona 3,6 kW; 1 Rapido 3 kW; 2 Semirapido 1,75 kW; 1 Ausiliario 1 kW
Accensione integrata nella manopola
Valvola di sicurezza
Griglie e coprispartifiamma in ghisa
Manopole flat silver

LEAF GAS ON GLASS 60

Piano a gas da incasso in cristallo temperato

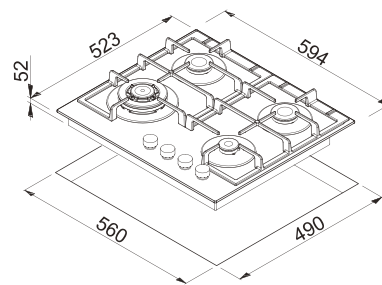

PIANO COTTURA IN VETRO ABBINABILE AI COLORI

FUNZIONALITÀ



KERATEK plus
CERAMIC NANOTECHNOLOGY CNB

Euro **756**

○ K96 White

PKCQ60296WS

● K86 Black

PKCQ60286WS

CARATTERISTICHE

Dimensioni (mm)	594 x 523
Foro da Incasso (mm)	560 x 490
Altezza Top (mm)	8
Ingombro Sottopiano (mm)	44

SPECIFICHE

4 fuochi a gas, di cui un tripla corona laterale
1 Tripla Corona 3,6 kW; 1 Rapido 3 kW; 2 Semirapido 1,75 kW; 1 Ausiliario 1 kW
Accensione integrata nella manopola
Valvola di sicurezza
Griglie e coprispartifiamma in ghisa
Manopole flat silver

TRIPLA CORONA



Una tripla corona (3 potenti cerchi di fuoco) è in grado di sviluppare e distribuire in modo omogeneo il calore, riducendo di conseguenza i tempi di cottura. La migliore ripartizione di calore sotto la pentola sfrutta al massimo la potenza e consente una cottura veloce e omogenea.

GRIGLIE IN GHISA



Le griglie, robuste e solide, rivestono un ruolo essenziale nelle fasi della cottura e garantiscono la massima stabilità ad ogni tipo di pentola. L'assenza di spigoli vivi ne facilita la pulizia e grazie alla resistenza del materiale la durata nel tempo è assicurata.

ESTETICA IN VETRO



La tipologia di piani cottura Gas on Glass è una delle più eleganti e funzionali a disposizione: la combinazione dell'estetica in vetro temperato con i potenti bruciatori della gamma è la soluzione di design ideale per associare bellezza e performance.

ACCENSIONE INTEGRATA SOTTOMANOPOLA



È sufficiente premere e contemporaneamente ruotare la manopola affinché vengano attivate sia l'erogazione del gas sia le scintille necessarie per accendere il bruciatore.

VALVOLA DI SICUREZZA

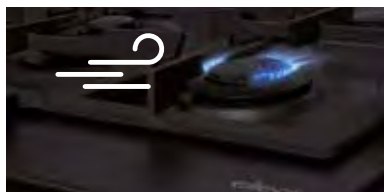

In caso di spegnimento accidentale della fiamma, il sistema di sicurezza interrompe l'erogazione del gas, garantendo così la massima sicurezza e praticità d'uso.

PLANO PLUS 75

NEW

Piano a gas da incasso smaltato

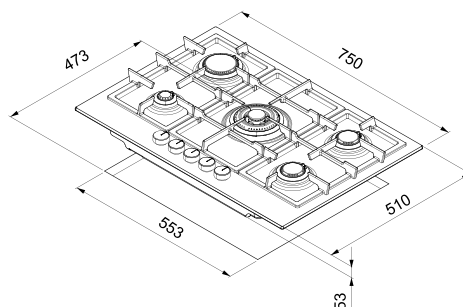

FUNZIONALITÀ



CARATTERISTICHE

Dimensioni (mm)	750 x 510
Foro da Incasso (mm)	553 x 473
Altezza Top (mm)	8
Ingombro Sottopiano (mm)	45

SPECIFICHE

5 fuochi flat a gas, di cui un tripla corona centrale
1 Tripla Corona 4 kW; 1 Rapido 3 kW; 2 Semirapido 1,75 kW; 1 Ausiliario 1 kW
Flame step control
Accensione integrata nella manopola
Valvola di sicurezza
Griglie e coprispartifiamma in ghisa
Manopole flat silver



K97 Light Grey



K96 White



K93 Dove Grey



G68 Bianco



G40 Nero

Manopola Nera Piano
Cottura Piano





AMP16301
Euro 17



PIANO COTTURA SMALTATO ABBINABILE AI COLORI

KERATEK Plus
CERAMIC NANOTECHNOLOGY CNG



Euro 1007

-  K97 Light Grey PKPP75197CS
-  K96 White PKPP75196CS
-  K93 Dove Grey PKPP75193CS
-  K86 Black PKPP75186CS

GRANITEK
NATURAL GRANITE EFFECT

Euro 1007

MATT

-  G68 Bianco PGPP75168CS
-  G40 Nero PGPP75140CS

FLAME STEP CONTROL



Flame Step Control permette di poter regolare con precisione 9 livelli di potenza della fiamma, per un controllo ottimale di tutte le fasi di cottura, importante specialmente nelle regolazioni intermedie.

FLAT BURNER



Con la loro particolare forma, i Flat Burners permettono di disperdere meno calore laterale, con migliore efficienza e miglior rendimento nell'erogazione della fiamma.

TRIPLA CORONA



Una tripla corona (3 potenti cerchi di fuoco) è in grado di sviluppare e distribuire in modo omogeneo il calore, riducendo di conseguenza i tempi di cottura. La migliore ripartizione di calore sotto la pentola sfrutta al massimo la potenza e consente una cottura veloce e omogenea.

GRIGLIE IN GHISA



Le griglie, robuste e solide, rivestono un ruolo essenziale nelle fasi della cottura e garantiscono la massima stabilità ad ogni tipo di pentola. L'assenza di spigoli vivi ne facilita la pulizia e grazie alla resistenza del materiale la durata nel tempo è assicurata.

ACCENSIONE INTEGRATA SOTTOMANOPOLA



È sufficiente premere e contemporaneamente ruotare la manopola affinché vengano attivate sia l'erogazione del gas sia le scintille necessarie per accendere il bruciatore.

VALVOLA DI SICUREZZA

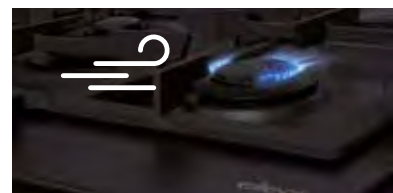

In caso di spegnimento accidentale della fiamma, il sistema di sicurezza interrompe l'erogazione del gas, garantendo così la massima sicurezza e praticità d'uso.



PLANO 75

Piano a gas da incasso smaltato

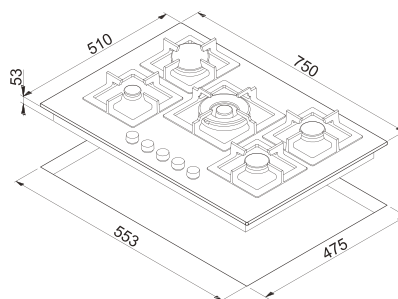

FUNZIONALITÀ



CARATTERISTICHE

Dimensioni (mm)	750 x 510
Foro da Incasso (mm)	553 x 475
Altezza Top (mm)	8
Ingombro Sottopiano (mm)	45

SPECIFICHE

5 fuochi a gas, di cui un tripla corona centrale
1 Tripla Corona 4 kW; 1 Rapido 3 kW; 2 Semirapido 1,75 kW; 1 Ausiliario 1 kW
Accensione integrata nella manopola
Valvola di sicurezza
Griglie e coprispartifiamma in ghisa
Manopole flat silver



M79 Aluminium



G68 Bianco



G43 Tortora



G40 Nero



G51 Avena



IN Inox

**Manopola Nera Piano
Cottura Piano**



AMP16301

Euro **17**

PIANO COTTURA SMALTATO ABBINABILE AI COLORI



Euro **667**

METAL

- M79 Aluminium PMSP75179CS
- M73 Titanium PMSP75173CS



Euro **652**

MATT

- G68 Bianco PGSP75168CS
- G43 Tortora PGSP75143CS
- G40 Nero PGSP75140CS
- CLASSIC
- G51 Avena PGSP75151CS

INOX

Euro **658**

- IN Inox

PIAP7511NCS

TRIPLA CORONA



Una tripla corona (3 potenti cerchi di fuoco) è in grado di sviluppare e distribuire in modo omogeneo il calore, riducendo di conseguenza i tempi di cottura. La migliore ripartizione di calore sotto la pentola sfrutta al massimo la potenza e consente una cottura veloce e omogenea.

GRIGLIE IN GHISA



Le griglie, robuste e solide, rivestono un ruolo essenziale nelle fasi della cottura e garantiscono la massima stabilità ad ogni tipo di pentola. L'assenza di spigoli vivi ne facilita la pulizia e grazie alla resistenza del materiale la durata nel tempo è assicurata.

ACCENSIONE INTEGRATA SOTTOMANOPIOLA



È sufficiente premere e contemporaneamente ruotare la manopola affinché vengano attivate sia l'erogazione del gas sia le scintille necessarie per accendere il bruciatore.

VALVOLA DI SICUREZZA

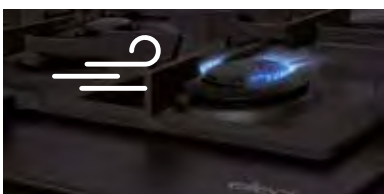

In caso di spegnimento accidentale della fiamma, il sistema di sicurezza interrompe l'erogazione del gas, garantendo così la massima sicurezza e praticità d'uso.

PLANO 60

Piano a gas da incasso smaltato

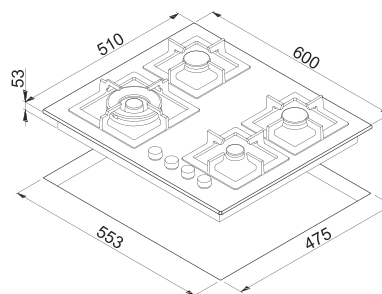

FUNZIONALITÀ



CARATTERISTICHE

Dimensioni (mm)	600 x 510
Foro da Incasso (mm)	553 x 475
Altezza Top (mm)	8
Ingombro Sottopiano (mm)	45

SPECIFICHE

4 fuochi a gas, di cui un tripla corona laterale
1 Tripla Corona 4 kW; 2 Semirapido 1,75 kW; 1 Ausiliario 1 kW
Accensione integrata nella manopola
Valvola di sicurezza
Griglie e coprispartifiamma in ghisa
Manopole flat silver

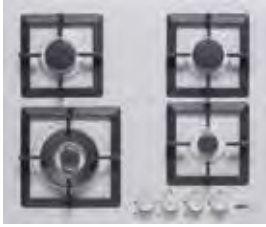

M79 Aluminium

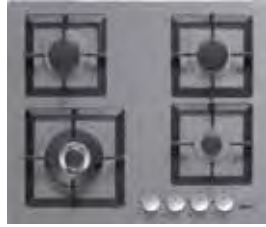

M73 Titanium

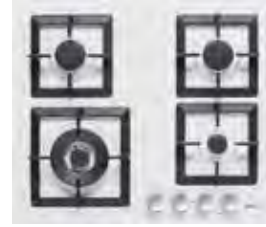

G68 Bianco



G43 Tortora



G51 Avena



IN Inox

**Manopola Nera Piano
Cottura Piano**

AMP16301
Euro **17**



PIANO COTTURA SMALTATO ABBINABILE AI COLORI



Euro **595**

- M79 Aluminium PMSP60179WS
- M73 Titanium PMSP60173WS



Euro **580**

- G68 Bianco PGSP60168WS
- G43 Tortora PGSP60143WS
- G40 Nero PGSP60140WS
- CLASSIC
- G51 Avena PGSP60151WS

INOX

Euro **586**

- IN Inox

PIAP601INWS

TRIPLA CORONA



Una tripla corona (3 potenti cerchi di fuoco) è in grado di sviluppare e distribuire in modo omogeneo il calore, riducendo di conseguenza i tempi di cottura. La migliore ripartizione di calore sotto la pentola sfrutta al massimo la potenza e consente una cottura veloce e omogenea.

GRIGLIE IN GHISA



Le griglie, robuste e solide, rivestono un ruolo essenziale nelle fasi della cottura e garantiscono la massima stabilità ad ogni tipo di pentola. L'assenza di spigoli vivi ne facilita la pulizia e grazie alla resistenza del materiale la durata nel tempo è assicurata.

ACCENSIONE INTEGRATA SOTTOMANOPIOLA



È sufficiente premere e contemporaneamente ruotare la manopola affinché vengano attivate sia l'erogazione del gas sia le scintille necessarie per accendere il bruciatore.

VALVOLA DI SICUREZZA

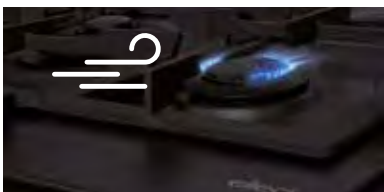

In caso di spegnimento accidentale della fiamma, il sistema di sicurezza interrompe l'erogazione del gas, garantendo così la massima sicurezza e praticità d'uso.

PLANO 90

Piano a gas da incasso smaltato

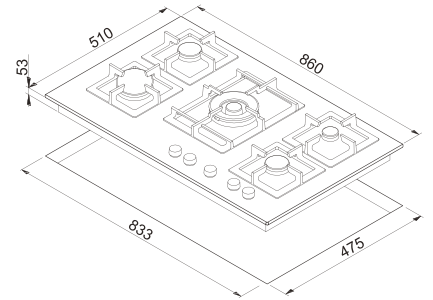

PIANO COTTURA SMALTATO ABBINABILE AI COLORI

GRANITEK
NATURAL GRANITE EFFECT

Euro **726**

MATT

○ G68 Bianco

PGSP90168CS

● G40 Nero

PGSP90140CS

FUNZIONALITÀ



CARATTERISTICHE

Dimensioni (mm)	860 x 510
Foro da Incasso (mm)	833 x 475
Altezza Top (mm)	8
Ingombro Sottopiano (mm)	45

SPECIFICHE

5 fuochi a gas, di cui un tripla corona centrale
1 Tripla Corona 4 kW; 1 Rapido 3 kW; 2 Semirapido 1,75 kW; 1 Ausiliario 1 kW
Accensione integrata nella manopola
Valvola di sicurezza
Griglie e coprispartifiamma in ghisa
Manopole flat silver

**Manopola Nera Piano
Cottura Piano**

AMP16301

Euro **17**



TRIPLA CORONA



Una tripla corona (3 potenti cerchi di fuoco) è in grado di sviluppare e distribuire in modo omogeneo il calore, riducendo di conseguenza i tempi di cottura. La migliore ripartizione di calore sotto la pentola sfrutta al massimo la potenza e consente una cottura veloce e omogenea.

GRIGLIE IN GHISA



Le griglie, robuste e solide, rivestono un ruolo essenziale nelle fasi della cottura e garantiscono la massima stabilità ad ogni tipo di pentola. L'assenza di spigoli vivi ne facilita la pulizia e grazie alla resistenza del materiale la durata nel tempo è assicurata.

ACCENSIONE INTEGRATA SOTTOMANOPIOLA



È sufficiente premere e contemporaneamente ruotare la manopola affinché vengano attivate sia l'erogazione del gas sia le scintille necessarie per accendere il bruciatore.

VALVOLA DI SICUREZZA

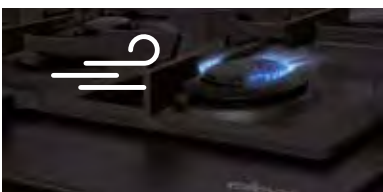

In caso di spegnimento accidentale della fiamma, il sistema di sicurezza interrompe l'erogazione del gas, garantendo così la massima sicurezza e praticità d'uso.

STYLE 90

Piano a gas da incasso smaltato

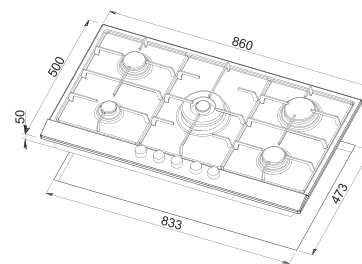

PIANO COTTURA SMALTATO ABBINABILE AI COLORI

FUNZIONALITÀ



GRANITEK
NATURAL GRANITE EFFECT

Euro **802**

CLASSIC

● G51 Avena

PGSS90251CNG

CARATTERISTICHE

Dimensioni (mm)	860 x 500
Foro da Incasso (mm)	833 x 473
Altezza Top (mm)	20
Ingombro Sottopiano (mm)	35

SPECIFICHE

5 fuochi a gas, di cui un tripla corona centrale
1 Tripla Corona 3,35 kW; 1 Rapido 3 kW; 2 Semirapido 1,75 kW; 1 Ausiliario 1 kW
Accensione integrata nella manopola
Valvola di sicurezza
Manopole flat nere
Griglie in ghisa

TRIPLA CORONA



Una tripla corona (3 potenti cerchi di fuoco) è in grado di sviluppare e distribuire in modo omogeneo il calore, riducendo di conseguenza i tempi di cottura. La migliore ripartizione di calore sotto la pentola sfrutta al massimo la potenza e consente una cottura veloce e omogenea.

GRIGLIE IN GHISA



Le griglie, robuste e solide, rivestono un ruolo essenziale nelle fasi della cottura e garantiscono la massima stabilità ad ogni tipo di pentola. L'assenza di spigoli vivi ne facilita la pulizia e grazie alla resistenza del materiale la durata nel tempo è assicurata.

Manopola Ottonata
Piano Cottura

AMP40302
Euro **27**



Manopola Silver Piano
Cottura Style

AMP50300
Euro **16**



Manopola Nera Piano
Cottura Style

AMP50301
Euro **17**





STYLE 75

NEW

Piano a gas da incasso smaltato

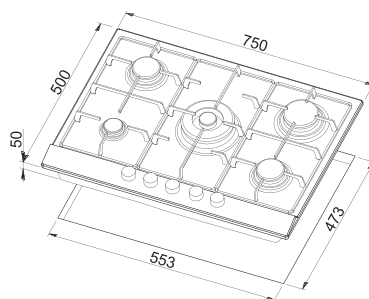

FUNZIONALITÀ



CARATTERISTICHE

Dimensioni (mm)	750 x 500
Foro da Incasso (mm)	553 x 473
Altezza Top (mm)	20
Ingombro Sottopiano (mm)	35

SPECIFICHE

5 fuochi a gas, di cui un tripla corona centrale
1 Tripla Corona 3,35 kW; 1 Rapido 3 kW; 2 Semirapido 1,75 kW; 1 Ausiliario 1 kW
Accensione integrata nella manopola
Valvola di sicurezza
Manopole flat nere
Griglie lamellari e piattelli opachi Nero Matt



G68 Bianco



G48 Cemento



G59 Antracite

**Manopola Ottonata
Piano Cottura**



AMP40302
Euro **27**

**Manopola Silver Piano
Cottura Style**



AMP50300
Euro **16**

**Manopola Nera Piano
Cottura Style**



AMP50301
Euro **17**

Griglie In Ghisa Style 75





AKG03303
Euro **206**

PIANO COTTURA SMALTATO ABBINABILE AI COLORI





Euro **606**

MATT

-  G68 Bianco PGSS75368CB
-  G48 Cemento PGSS75348CB

CLASSIC

-  G59 Antracite PGSS75359CB
-  G51 Avena PGSS75351CB

TRIPLA CORONA



Una tripla corona (3 potenti cerchi di fuoco) è in grado di sviluppare e distribuire in modo omogeneo il calore, riducendo di conseguenza i tempi di cottura. La migliore ripartizione di calore sotto la pentola sfrutta al massimo la potenza e consente una cottura veloce e omogenea.

GRIGLIE LAMELLARI E PIATTI OPACHI



Le griglie lamellari e i piattelli opachi black matt conferiscono un tocco ulteriore di matericità al piano di cottura Style, rendendolo la scelta ottimale per arredare gli ambienti cucina classici.

ACCENSIONE INTEGRATA SOTTOMANOPOLA



È sufficiente premere e contemporaneamente ruotare la manopola affinché vengano attivate sia l'erogazione del gas sia le scintille necessarie per accendere il bruciatore.

VALVOLA DI SICUREZZA

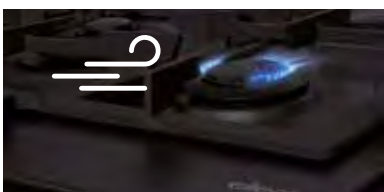

In caso di spegnimento accidentale della fiamma, il sistema di sicurezza interrompe l'erogazione del gas, garantendo così la massima sicurezza e praticità d'uso.

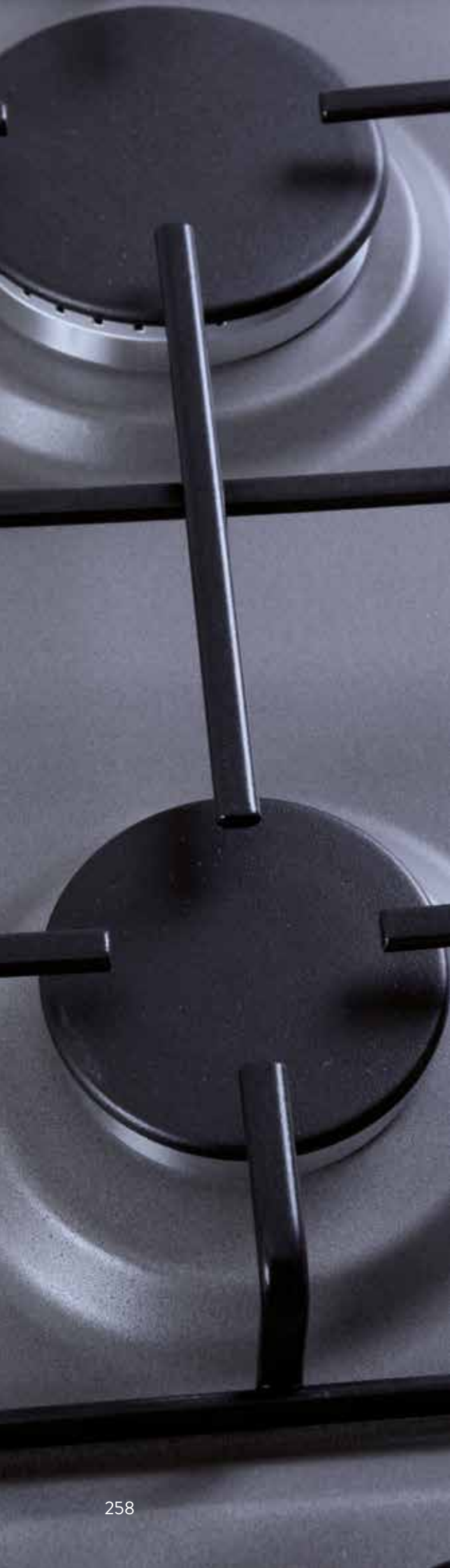

STYLE 60

NEW

Piano a gas da incasso smaltato

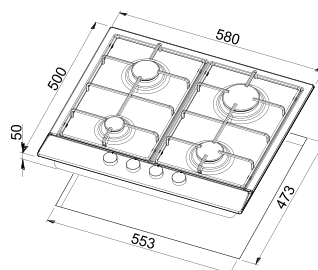

FUNZIONALITÀ



CARATTERISTICHE

Dimensioni (mm)	580 x 500
Foro da Incasso (mm)	553 x 473
Altezza Top (mm)	20
Ingombro Sottopiano (mm)	35

SPECIFICHE

4 fuochi a gas
1 Rapido 3 kW; 2 Semirapido 1,75 kW; 1 Ausiliario 1 kW
Accensione integrata nella manopola
Valvola di sicurezza
Manopole flat nere
Griglie lamellari e piattelli opachi Nero Matt



G68 Bianco



G59 Antracite



G51 Avena

**Manopola Ottonata
Piano Cottura**



AMP40302
Euro **27**

**Manopola Silver Piano
Cottura Style**



AMP50300
Euro **16**

**Manopola Nera Piano
Cottura Style**



AMP50301
Euro **17**

Griglie In Ghisa Style 60

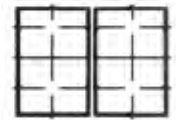



AKG01304
Euro **140**

PIANO COTTURA SMALTATO ABBINABILE AI COLORI





Euro **475**

MATT

-  G68 Bianco PGSS60268WB
-  G48 Cemento PGSS60248WB

CLASSIC

-  G59 Antracite PGSS60259WB
-  G51 Avena PGSS60251WB

GRIGLIE LAMELLARI E PIATTI OPACI



Le griglie lamellari e i piattelli opaci black matt conferiscono un tocco ulteriore di matericità al piano di cottura Style, rendendolo la scelta ottimale per arredare gli ambienti cucina classici.

ACCENSIONE INTEGRATA SOTTOMANOPOLA



È sufficiente premere e contemporaneamente ruotare la manopola affinché vengano attivate sia l'erogazione del gas sia le scintille necessarie per accendere il bruciatore.

VALVOLA DI SICUREZZA

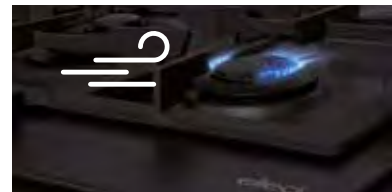

In caso di spegnimento accidentale della fiamma, il sistema di sicurezza interrompe l'erogazione del gas, garantendo così la massima sicurezza e praticità d'uso.

LEAF VERTICAL

Cappa aspirante verticale in vetro satinato e lucido



NEW

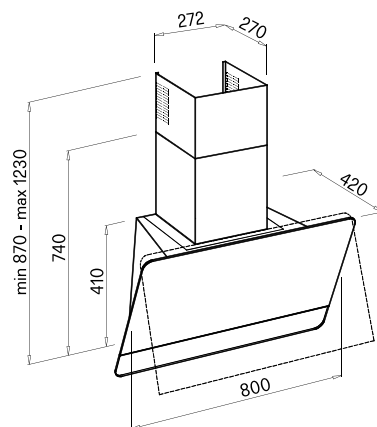

CARATTERISTICHE

Dimensioni (mm)	800 x 1230 x 420
Comandi	Touch control sul vetro
Numero Velocità	4
Portata Massima	750 m³/h
Pressione	565 Pa
Rumorosità Massima	65 dbA
Bocca Uscita	150
Classe Energetica	A

ESTETICA CAPPa IN VETRO ABBINABILE AI COLORI

KERATEK plus
CERAMIC NANOTECHNOLOGY CNB

Euro **1505**

○ K96 White

KKQ80096VST

● K86 Black

KKQ80086VST

Accessorio

Filtro carbone

Codice

AFC01302

Euro

57

LEAF BOX

Cappa aspirante in acciaio Inox e vetro frontale



NEW

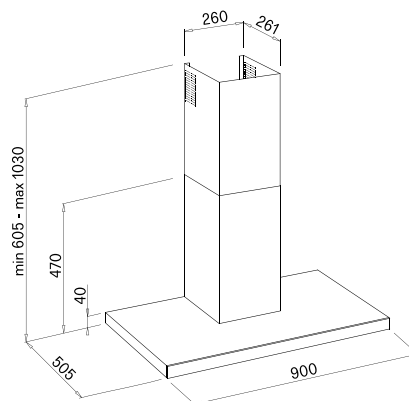

CARATTERISTICHE

Dimensioni (mm)	900 x 1030 x 505
Comandi	Touch control
Numero Velocità	3+1
Portata Massima	680 m³/h
Pressione	436 Pa
Rumorosità Massima	69 dbA
Bocca Uscita	150
Classe Energetica	A

ESTETICA CAPPa IN ACCIAIO INOX E VETRO ABBINABILE AI COLORI

KERATEK plus
CERAMIC NANOTECHNOLOGY CNB

Euro **1160**

○ K96 White

KKL90096VST

● K86 Black

KKL90086VST

Accessori

Filtro carbone

Codice

AFC01303

Euro

106

Kit deviatore aria

ADA01300

30



NEW

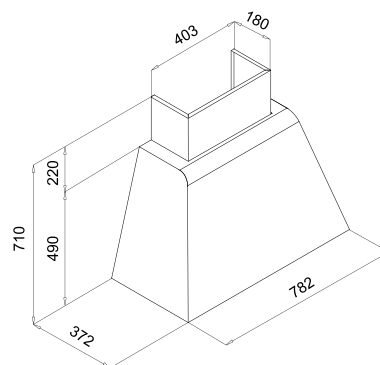

CARATTERISTICHE

Dimensioni (mm)	782 x 372 x 490
Comandi	Slider
Numero Velocità	3
Portata Massima	368 m ³ /h
Pressione	218 Pa
Rumorosità Massima	58 dbA
Bocca Uscita	120
Classe Energetica	D

ESTETICA CAPPA SMALTATA ABBINABILE AI COLORI

GRANITEK
NATURAL GRANITE EFFECT

Euro 815

MATT



G40 Nero

KGPB8040M

Accessorio

Filtro carbone

Codice Euro

AFC01304 87



NEW

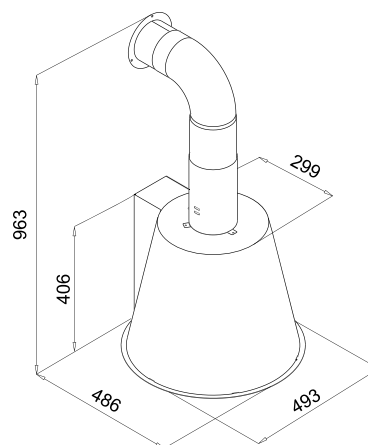

CARATTERISTICHE

Dimensioni (mm)	∅ 493 x h 406
Comandi	Slider
Numero Velocità	3
Portata Massima	520 m ³ /h
Pressione	151 Pa
Rumorosità Massima	65 dbA
Bocca Uscita	120
Classe Energetica	D

ESTETICA CAPPA SMALTATA ABBINABILE AI COLORI

GRANITEK
NATURAL GRANITE EFFECT

Euro 697

MATT



G40 Nero

KGPURO40M

Accessorio

Filtro carbone

Codice Euro

AFC01305 87

COLLEZIONE

DISSIPATORI

Il dissipatore di rifiuti alimentari (DRA) è un moderno elettrodomestico essenziale che ci libera dai rifiuti organici e rende la nostra vita più facile in cucina. È sufficiente premere un solo pulsante e il cibo verrà tritato e smaltito. Facile da installare, non ingombrante, silenzioso e sicuro. I rifiuti vengono ridotti in piccole particelle e scaricati nel sistema fognario attraverso l'acqua.

Vantaggi:

Niente più cattivi odori
Risparmio economico
Riduzione dei rifiuti da smaltire
Ambiente più sano
Riduzione CO2

Più silenzioso del 40%

Tutti i dissipatori Elleci sono progettati per ridurre al minimo il coefficiente di vibrazione e la rumorosità. Con la combinazione di questi due fattori i dissipatori Elleci sono più silenziosi del 40% rispetto ai prodotti tradizionali.

Grande camera di dissipazione

Una cavità volumetrica maggiore comporta un minor rischio di intasamento e una migliore triturazione.



Attraverso questo elettrodomestico è possibile smaltire rifiuti organici quali: frutta, verdura, lische di pesce, gusci, ossa di pollo e molti altri.

Non è possibile smaltire cibi fibrosi quali: carciofi, finocchi, ananas, ecc.

STAINLESS STEEL HIGH QUALITY PARTS



1 Installazione facile e veloce

5 Innovativo Design Italiano

2 Protezione Antibatterica e Sistema Antiodore

6 Sistema Reset di Sicurezza

3 Componenti in acciaio inox

7 Interruttore pneumatico ad aria incluso

4 Motore a corrente diretta ad elevata potenza



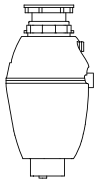

MODELLO 1000 TOP
PAG. 264

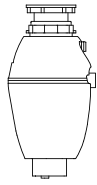

MODELLO 750 TOP
PAG. 264

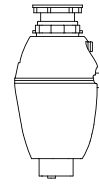

MODELLO 750
PAG. 264

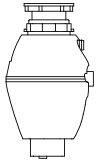

MODELLO 500 TOP
PAG. 265

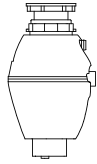

MODELLO 500
PAG. 265



MODELLO 1000 TOP

Deluxe 1 Hp

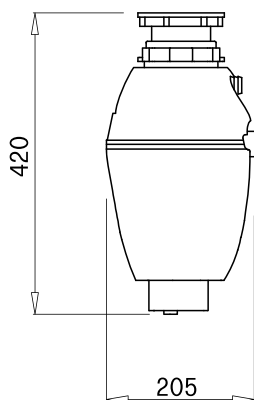

4 ANNI - YEARS
WARRANTY
GARANTITO

CARATTERISTICHE

Dimensioni (mm) 205 x 420

4.8
KG

Modello	Prezzo Euro
TDH01000	495
Potenza Watt:	750
Tensione VAC:	220/240
Assorbimento (Ampere):	3,4
r/min.:	2800
Peso (kg) VAC:	4,8
Capacità:	1070 ml.

MODELLO 750 TOP

Deluxe 0.75 Hp

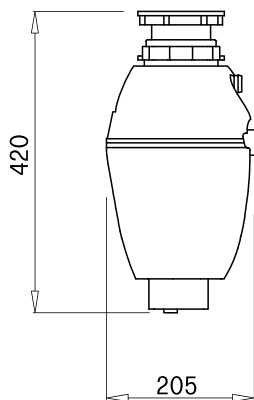

4 ANNI - YEARS
WARRANTY
GARANTITO

CARATTERISTICHE

Dimensioni (mm) 205 x 420

4.7
KG

Modello	Prezzo Euro
TDH00750	441
Potenza Watt:	550
Tensione VAC:	220/240
Assorbimento (Ampere):	2,5
r/min.:	2800
Peso (kg) VAC:	4,7
Capacità:	1070 ml.

MODELLO 750

0.75 Hp

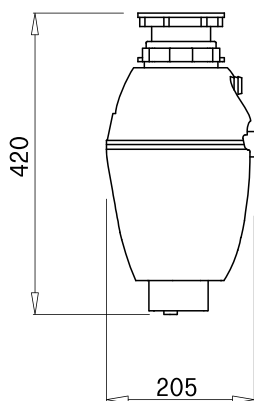

2 ANNI - YEARS
WARRANTY
GARANTITO

CARATTERISTICHE

Dimensioni (mm) 205 x 420

4.5
KG

Modello	Prezzo Euro
TDM00750	410
Potenza Watt:	550
Tensione VAC:	220/240
Assorbimento (Ampere):	2,5
r/min.:	2800
Peso (kg) VAC:	4,5
Capacità:	860 ml.

MODELLO 500 TOP

Deluxe 0.5 Hp

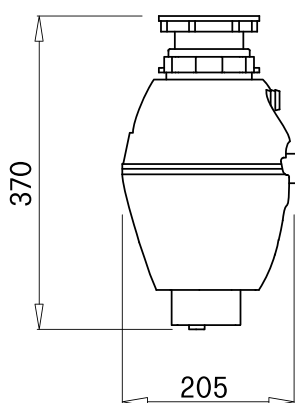

4 ANNI - YEARS
WARRANTY
GARANTITO

CARATTERISTICHE

Dimensioni (mm) 205 x 370

4.5
KG

Modello	Prezzo Euro
TDH00500	359
Potenza Watt:	375
Tensione VAC:	220/240
Assorbimento (Ampere):	1,7
r/min.:	2800
Peso (kg) VAC:	4,5
Capacità:	1070 ml.

MODELLO 500

0.5 Hp

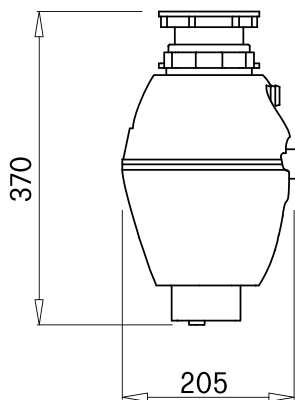

2 ANNI - YEARS
WARRANTY
GARANTITO

CARATTERISTICHE

Dimensioni (mm) 205 x 370

4.3
KG

Modello	Prezzo Euro
TDM00500	337
Potenza Watt:	375
Tensione VAC:	220/240
Assorbimento (Ampere):	1,7
r/min.:	2800
Peso (kg) VAC:	4,3
Capacità:	860 ml.

Accessori inclusi



Spingitore rifiuti.



Gomma paraspruzzi
removibile e lavabile
(anche in lavastoviglie).



Tappo standard.



Gomito
di fissaggio.



**Air switch: attuatore pneumatico (pulsante
di accensione ad aria, non elettronico).**

Accessori consigliati



Flangia dissipatore
per piletta quadrata

ATQ01300
€ 37



Radiocomando
accensione

ARP01300
€ 81

ESPOSITORE



Consigliamo di esporre i
seguenti articoli: TDM00750
o TDH00750.

Nella parte superiore
consigliamo di allocare i
leaflet Green Power (codice:
LEAI007).

Modello	Prezzo Euro
ESPDISSIT	128

Espositore da banco per nr. 1 dissipatore Green Power.
Espositore realizzato in plexiglass bicolour (trasparente/verde).



ELLECI SEMPRE PIÙ VICINO A TE

Elceci ha cura dei propri clienti e lo dimostra utilizzando i materiali più innovativi e le tecnologie più all'avanguardia per offrire il massimo della qualità. Qualità certificata da precise norme di produzione, conformi a ISO 45001:2018, ISO 14001:2015 e ISO 9001:2015.

Elceci ti assicura una garanzia della durata variabile, a seconda della categoria del prodotto che hai scelto. Tali durate sono indicate nei rispettivi manuali di utilizzo/installazione.

PRODOTTO	GARANZIA
LAVELLI IN COMPOSITO - KERATEK PLUS	20 ANNI
LAVELLI IN COMPOSITO - GRANITEK	10 ANNI
LAVELLI INOX / MISCELATORI / ELETTRODOMESTICI / ACCESSORI	2 ANNI
DISSIPATORI	4 ANNI / 2 ANNI a seconda del modello

UN NUOVO NUMERO VERDE A TUA DISPOSIZIONE, UN NUOVO SERVIZIO DI ASSISTENZA PRE E POST-VENDITA

Elceci ha potenziato il suo Customer Care, un vero e proprio team di professionisti pronto ad offrirti un servizio ancora più tempestivo ed efficiente. Un solo numero verde per gestire tutte le richieste, **attivo dal lunedì al venerdì dalle 8.30 alle 13.00 e dalle 14.00 alle 17.30**, e raggiungibile sia da numero fisso sia da smartphone.



Il Customer Care Elceci sarà al tuo fianco in modo rapido e affidabile, provvedendo a trovare la soluzione più idonea per garantire la tua piena soddisfazione.



LA TUA SODDISFAZIONE È IL NOSTRO OBIETTIVO

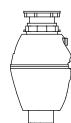
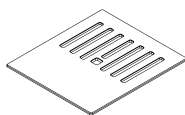
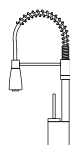
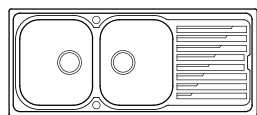
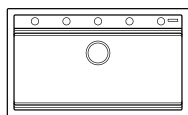

In caso di assistenza tecnica su lavelli in composito, lavelli inox, miscelatori, accessori e dissipatori, e dopo l'inserimento dei necessari dati e documentazioni, il Customer Care elaborerà la pratica, fornendoti riscontro entro le 48 ore successive.

Se la pratica rientra in garanzia, essa verrà conclusa nell'arco dei 7 giorni successivi alla data dell'invio della mail con la comunicazione dell'esito della pratica stessa.

LA DISPONIBILITÀ, IL SUPPORTO E L'ASSISTENZA DI PERSONALE QUALIFICATO

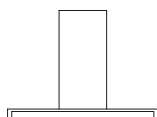
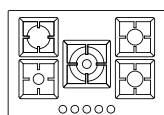
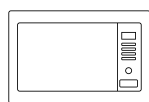
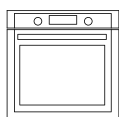

In caso di segnalazioni riguardanti gli elettrodomestici (piani cottura, forni e cappe), esse verranno gestite tramite circa 350 centri di assistenza tecnica (CAT) da noi appositamente incaricati. Anche in questo caso, dopo aver fornito i necessari dati e documentazioni, il Customer Care Elleci prenderà contatto con te entro le 48 ore successive alla segnalazione per definire e concordare le successive tempistiche di uscita e/o di risoluzione pratica.



Si raccomanda vivamente di conservare la ricevuta/fattura comprovante l'acquisto, senza la quale non potremo procedere ad alcun tipo di intervento in garanzia.

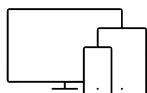

Per maggiori informazioni, puoi consultare il sito www.elleci.com.

TABELLA

COMPARATIVA

PRINCIPALI MARCHI DI ELETTRODOMESTICI E TOP CUCINA



SMEG HOTPOINT INDESIT ELECTROLUX WHIRLPOOL BOSCH CANDY SIEMENS FENIX



K99 Dark Grey									
K97 Light Grey									grigio antrim
K96 White	vetro bianco	bianco	bianco	vetro bianco	bianco	bianco	vetro bianco	bianco	bianco kos
K95 Champagne									
K93 Dove Grey									grigio londra
K86 Black	vetro nero	nero	nero	vetro nero	nero	nero	vetro nero	nero	nero ingo



M79 Aluminium	alluminio	-	-	-	-	-	-	-
M78 Espresso	-	caffè	-	-	-	-	-	-
M73 Titanium	titanio	-	-	-	-	-	-	-
M70 Ghisa								



G68 Bianco	bianco	bianco	bianco	bianco	bianco	bianco	bianco	-
G48 Cemento								
G43 Tortora	-	-	tortora	-	-	-	-	-
G40 Nero	nero	-	nero	nero	nero	nero	vetro nero	-
G62 Bianco antico	panna	bianco antico	-	bianco antico	jasmine	-	-	-
G59 Antracite	antracite	antracite	antracite	nero ghisa	antracite	-	ghisa	-
G55 Grigio pietra								
G54 Nero pietra								
G52 Bianco pietra	-	granito bianco	-	-	-	-	-	-
G51 Avena	avena	avena	avena	sabbia	avena	-	avena	-

REALIZZATO DA ELLECI S.P.A.

Art direction

Copywriting

in collaborazione con

MANDARINO ADV S.R.L.

Design and Communication

ARCHÈ AGENCY S.R.L.

Scenic Art Direction

Photorealistic 3D

ORILIA ADV

Fotografie e post-produzione immagini

BIEFFE SRL

Stampa

Stampato su carta certificata FSC.

IL CATALOGO È PROPRIETÀ DI ELLECI S.P.A. TUTTI I DIRITTI SONO RISERVATI.

Sono tassativamente vietate le riproduzioni del presente catalogo, anche parziali, per fini commerciali senza specifica autorizzazione da parte di Elleci.

Elleci S.p.A. declina ogni responsabilità per possibili errori o inesattezze contenute nel catalogo, oltre a precisare che le immagini inserite e i dati forniti sono puramente indicativi.

LA STAMPA TIPOGRAFICA NON SEMPRE RIPRODUCE FEDELMENTE LE TINTE ED I MATERIALI ORIGINALI.

La riproduzione dei colori è PERTANTO da ritenersi puramente indicativa.

ELLECI S.P.A. SI RISERVA DI APPORTARE IN QUALSIASI MOMENTO E SENZA PREAVVISO MODIFICHE RITENUTE UTILI AL MIGLIORAMENTO DEI PROPRI PRODOTTI PRESENTI SU QUESTO CATALOGO.

I prezzi riportati nel presente Catalogo Listino sono al netto di IVA, trasporto ed eventuale ECO-Contributo RAEE.

LE COLORAZIONI DEI MATERIALI

VANTAGGI KERATEK PLUS E GRANITEK



RESISTENTE AGLI SHOCK TERMICI



RESISTENTE ALL'URTO



FATTO PER DURARE



PROTEZIONE IGIENICA, CERTIFICATA PER IL CONTATTO CON GLI ALIMENTI



CERTIFICATO GREENGUARD

KERATEK[®] Plus
CERAMIC NANOTECHNOLOGY CN6



SUPERFICIE ULTRACOMPATTA



20 ANNI-YEARS WARRANTY
GARANTITO

K99



DARK GREY

K97



LIGHT GREY

K96

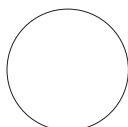

WHITE

K95



CHAMPAGNE

K93



DOVE GREY

K86



BLACK

GRANITEK[®]
NATURAL GRANITE EFFECT



SUPERFICIE ULTRAMATERICA

10 ANNI-YEARS WARRANTY
GARANTITO

METAL

M79



ALUMINIUM

M78



ESPRESSO

M73



TITANIUM

M70



GHISA

MATT

G68

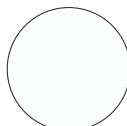

BIANCO

G48



CEMENTO

G43



TORTORA

G40



NERO

CLASSIC

G62



BIANCO ANTICO

G59



ANTRACITE

G55



GRIGIO PIETRA

G54



NERO PIETRA

G52



BIANCO PIETRA

G51



AVENA



italian origin

ELLECI S.p.A. Strada Longitudinale A 1258,
Z.I. Mazzocchio 04014 Pontinia (LT) - Italy
Tel. +39 0773 84 00 36
Fax +39 0773 85 35 17
www.elleci.com - email: elleci@elleci.it

